

# INSTALLATION OPERATION AND SERVICE MANUAL

## DYNAFLAME® SERIES



**GAS FIRED COMMERCIAL COPPER TUBE AND STAINLESS  
STEEL BOILERS**



**NON-CONDENSING**

*Models; DFH/W500, 750, 1100, 1200, 1500, 1750, 2000, 2500,  
3000, 3500, 4000, 4500, 4504, 5000, 5004, 6004*

**NEAR-CONDENSING (DFX)**

*Models; DFH/W501, 751, 1101, 1201, 1501, 1751, 2001, 2501, 3001,  
3501, 4001, 4501, 4514, 5001, 5014, 6014*

**CONDENSING**

*Models; DFH/W502, 752, 1102, 1202, 1502, 1752, 2002, 2502, 3002,  
3502, 4002, 4502, 4524, 5002, 5024, 6024*



H



HLW

**WARNING:**

If the information in these instructions is not followed exactly, a fire or explosion may result causing property damage, personal injury or death

Do not store or use gasoline or other flammable vapours and liquids in the vicinity of this or any other appliance.

**WHAT TO DO IF YOU SMELL GAS**

- Do not try to light any appliance,
- Do not touch any electrical switch; do not use any phone in your building,
- Immediately call your gas supplier from a neighbour's phone. Follow the gas supplier's instructions,
- If you cannot reach your gas supplier, call the fire department.

**Qualified installer, service agency or the gas supplier must perform installation and service.**

**To the Installer:** After installation, these instructions must be given to the end user or left on or near the appliance.

**To the End User:** This booklet contains important information about this appliance. Retain for future reference.



**CAMUS® HYDRONICS LTD.**

6226 Netherhart Road, Mississauga, Ontario, L5T 1B7

99-0050  
Rev. 6.8



## **Table of Contents**

PART 1	GENERAL INFORMATION .....	1
1.1	OVERVIEW.....	1
1.2	INTRODUCTION.....	1
1.3	SPECIAL INSTRUCTIONS TO OWNER .....	1
1.4	CHECKING EQUIPMENT.....	2
1.5	HOW IT OPERATES (SEQUENCE OF OPERATION).....	2
1.6.1	IGNITION PROCESS.....	3
1.6.2	HEAT TRANSFER PROCESS.....	3
1.6.3	END OF SEQUENCE.....	3
1.7	CODES .....	3
1.8	WARRANTY .....	4
1.9	REMOVAL OF EXISTING APPLIANCE .....	4
1.10	BOILER ROOM OPERATING CONDITION .....	5
1.11	CLEARANCE FROM COMBUSTIBLE MATERIAL .....	5
1.12	INSTALLATION PROCEDURE AND LOCATION OF UNIT.....	6
PART 2	AIR SUPPLY & VENTING.....	8
2.1	GENERAL VENTING GUIDE .....	8
2.1.1	CATEGORY I AND CATEGORY III VENTING.....	8
2.1.2	VENTING GUIDELINES FOR CATEGORY III VENTING.....	8
2.1.3	CATEGORY II AND CATEGORY IV VENTING .....	9
2.1.4	VENTING GUIDELINES FOR CATEGORY IV VENTING .....	9
2.1.5	APPROVED VENTING MATERIALS .....	9
2.1.6	VENT TERMINATION CLEARANCES .....	9
2.1.7	INLET CAP FOR ROOFTOP TERMINATION .....	10
2.1.8	LOCATION OF A ROOFTOP AIR INLET AND VENT CAPS.....	10
2.1.9	AIR INLET DAMPER.....	10
2.1.10	MASONARY CHIMNEY INSULATIONS .....	10
2.1.11	VERTICAL VENTING TERMINATION.....	10
2.1.12	COMBINED COMBUSTION AIR INLET.....	10
2.1.13	DRAIN TEE .....	11
2.2	CONVENTIONAL VENTING (INDOOR) INSTALLATIONS.....	11
2.2.1	AIR REQUIRED FOR COMBUSTION AND VENTILATION .....	12
2.2.2	EXHAUST FANS.....	12
2.3	OUTDOOR VENTING.....	12
2.4	THRUWALL VENTING .....	12
2.4.1	THRUWALL VENT CAP (14-0090) THRUWALL INTAKE AIR CAP (14-0101) .....	12
2.4.2	LOCATION OF A THRUWALL VENT TERMINATION.....	13
2.4.3	LOCATION OF A “THRUWALL” AIR INLET CAP.....	13
2.4.4	LENGTH OF AIR INLET PIPE.....	13
PART 3	GAS CONNECTION .....	13
3.1	GAS CONNECTION .....	13
3.2	GAS PIPING.....	14
3.3	INSTALL PIPING .....	14
3.4	AIR/GAS RATIO VALVE .....	14
3.5	DIFFERENTIAL AIR PRESSURE (DF2000 -6004) .....	15
3.6	GAS MANIFOLD DIFFERENTIAL PRESSURE ADJUSTMENT (DF2000 – DF6004) .....	15
3.7	CHECKING GAS SUPPLY PRESSURE.....	15
3.8	CHECKING DIFFERENTIAL AIR AND GAS PRESSURES (DF2000 - DF6000).....	16
3.9	GAS TRAIN AND CONTROLS .....	16
3.10	VENTING OF GAS VALVES AND PRESSURE SWITCHES .....	17
3.11	BURNER.....	17
PART 4	WATER CONNECTION .....	17
4.1	FREEZE PROTECTION.....	18

4.2	WARNING REGARDING CHILLED WATER & HEATING COIL SYSTEMS .....	18
4.3	INLET AND OUTLET CONNECTIONS.....	18
4.4	MINIMUM PIPE SIZE REQUIREMENTS.....	18
4.5	PRIMARY HEAT EXCHANGER.....	18
4.6	LOW WATER TEMPERATURE SYSTEMS.....	19
4.7	INSTANTANEOUS WATER HEATER (non-condensing).....	19
4.8	CONDENSER HEAT RECOVERY MODULE (CHRM).....	20
4.9	CHRM, FLOW and PRESSURE DROP .....	21
4.10	WATER FLOW SWITCH (shipped loose) .....	21
4.11	LOW WATER CUTOFF (If Equipped) .....	22
4.12	RELIEF VALVE (shipped loose).....	22
4.13	CONDENSING HEAT RECOVERY MODULE PIPING CONFIGURATIONS .....	22
4.13.1	CHRM IN SERIES WITH PRIMARY HEAT EXCHANGER (INTEGRATED LOOP).....	22
4.14	CIRCULATING PUMP SELECTION .....	22
4.14.1	CIRCULATING PUMP OPERATION PRIMARY HEAT EXCHANGER .....	22
4.14.2	CIRCULATING PUMP SELECTION CONDENSOR .....	23
PART 5	ELECTRICAL & CONTROLS .....	23
5.1	ELECTRICAL CONECTIONS .....	23
5.2	VARIABLE FREQUENCY DRIVE (VFD) .....	24
5.3	DIFFERENTIAL AIR PRESSURE SWITCH .....	24
5.4	BLOCKED FLUE SWITCH.....	24
5.5	HIGH and LOW GAS PRESSURE SWITCHES (Optional) .....	24
5.6	HIGH LIMIT .....	24
5.7	DYNAFLAME® SOLA.....	25
5.7.1	SERVICE PARTS.....	25
5.7.2	IGNITION MODULE LOCKOUT FUNCTIONS .....	25
5.8	DYNAFLAME CONTROLLER.....	25
5.9	ERROR TABLE .....	25
PART 6	SOLA CONTROL PANEL.....	27
6.1	APPLIANCE TEMPERATURE CONTROLLER.....	27
6.2	CONFIGURE MENU.....	43
6.3	LEAD LAG SETUP .....	45
6.5	LOCAL/REMOTE SWITCH.....	46
6.6	COMM. PORT 2 ACTIVATION .....	46
6.7	VARIABLE FREQUENCY DRIVE .....	46
6.8	FROST PROTECTION .....	46
PART 7	COMPONENTS.....	47
7.1	HOT SURFACE IGNITER (GLOW BAR) .....	47
7.2	FLAME SENSOR .....	47
7.3	COMBUSTION AIR FAN.....	47
7.4	INNER JACKET.....	47
7.5	OUTER JACKET.....	47
7.6	VENTING TRANSITION.....	47
PART 8	FIELD STARTUP PROCEDURE .....	48
8.1	CHECKING THE INSTALLATION .....	48
8.2	CHECKING THE CONSTRUCTION .....	48
8.3	FIRE TESTING.....	48
8.4	COMISSIONING APPLIANCE .....	51
PART 9	TROUBLE SHOOTING.....	52
PART 10	MAINTENANCE.....	59
10.1	EXAMINE THE VENTING SYSTEM .....	59
10.2	VISUALLY CHECK MAIN BURNER FLAMES.....	59
10.3	FLUE GAS PASSAGEWAYS CLEANING PROCEDURES .....	59
10.4	CONDENSATION TREATMENT.....	59
10.4.1	CONDENSATE VOLUME.....	59
10.5	BURNER MAINTENANCE .....	60

10.5.1	BURNER REMOVAL AND CLEANING .....	60
10.5.2	BURNER CLEANING PROCEDURE .....	60
10.6	CHANGING THE HOT SURFACE IGNITER .....	60
10.6.1	RE-INSTALLING THE IGNITER.....	61
10.7	PRIMARY HEAT EXCHANGER INSPECTION .....	61
10.8	CONDENSING HEAT RECOVERY MODULE (CHRM) INSPECTION .....	61
10.9	RE-INSTALL HEAT EXCHANGERS.....	61
10.10	COMBUSTION AIR FAN.....	61
10.11	COMBUSTION AND VENTILATION AIR .....	61
10.12	CONTROL CIRCUIT VOLTAGE.....	61
10.13	COMBUSTIBLE MATERIALS .....	61
10.14	FREEZE PROTECTION.....	61
10.15	FREEZE PROTECTION FOR A HEATING BOILER SYSTEM (Optional) .....	62
PART 11	INSTALLATIONS .....	62
11.1	HEATING BOILER INSTALLATIONS .....	62
11.2	WATER CONNECTIONS.....	62
11.3	PIPING LENGTHS .....	62
11.4	INTERMITTENT PUMP OPERATION .....	63
11.5	SUMMARY .....	63
11.6	DOMESTIC HOT WATER HEATER.....	63
11.7	WATER VELOCITY CONTROL .....	63
11.8	TEMPERATURE RISE AT FULL FIRING RATE .....	64
11.9	WATER HEATERS .....	64
PART 12	EXPLODED VIEW .....	65
PART 13	ELECTRICAL DIAGRAMS.....	76
	WARRANTY .....	80

# PART 1 GENERAL INFORMATION

## 1.1 OVERVIEW

The DynaFlame® is available in the following body styles:

- 23" x 27" footprint, DynaFlame® As non-condensing 85% efficient, available in models 500, 750, 1100, 1200. As near condensing (DFX) 88% efficient DFX, available in models 501, 751, 1101, 1201. As full condensing 95% efficient, available in models 502, 752, 1102, 1202
- 29 1/2" x 34" footprint, DynaFlame®. As non-condensing 85% efficient, available in models 1500, 1750, 2000, 2500, 3000, 3500, 4000, 4500, 5000. As near-condensing (DFX) 88% efficient, available in models 1501, 1751, 2001, 2501, 3001, 3501, 4001, 4501, 5001. As full condensing 95% efficient, available in modes 1502, 1752, 2002, 2502, 3002, 3502, 4002, 4502, 5002
- 35 3/4" x 39 1/4" footprint DynaFlame® Mega. As non-condensing 85% efficient, available in models 4504, 5004, 6004. As near condensing (DFX) 88% efficient DFX, available in models 4514, 5014, 6014. As full condensing 95% efficient, available in models 4524, 5024, 6024

## 1.2 INTRODUCTION

The DynaFlame® is a forced draft appliance utilizing a premix power burner based on push through design which offers several venting options. Heat output is controlled by a one to one air/gas ratio control gas valve which provides seamless modulation. The DynaFlame® provides central heating and/or domestic hot water at working pressure up to 160 PSI. It is designed for use with a fully pumped and pressurized system. The boiler/water heater will automatically modulate to provide heat outputs between 100% to approximately 35% of rated input on non-condensing models and down to 20% on near condensing (DFX) and condensing models.

The DynaFlame® works on the principle of differential pressure. The operation of the fan will generate a differential pressure, which the gas/air ratio control gas valve will match on the gas side. The steady state efficiency is maintained across the entire range of modulation. Air and gas are metered in precise proportion (1:1 Ratio) to modulation signal, allowing combustion characteristics which determine efficiency to remain the same over entire operating range.

### DynaFlame® Non-Condensing

In this series most of the sensible heat value is being transferred into the water. The unused portion of the sensible heat and all the latent heat is released through the exhaust vent. The overall efficiency of the DynaFlame® is being improved by incorporating preheat of intake combustion air which consequently maintains the outer panels cool and thus reduces jacket loss.

### DynaFlame® Near Condensing

In this series most of the sensible heat value is being transferred into the water. The unused portion of the sensible heat is too small to maintain flue products in a gaseous state. Therefore condensation is formed in the vent. The defining characteristics of the DFX are reduced vent sizes at reduced equivalent vent lengths of 50 ft, and continuous modulation permitted down to 20% of input.

Figure 1: DynaFlame® Non-Condensing

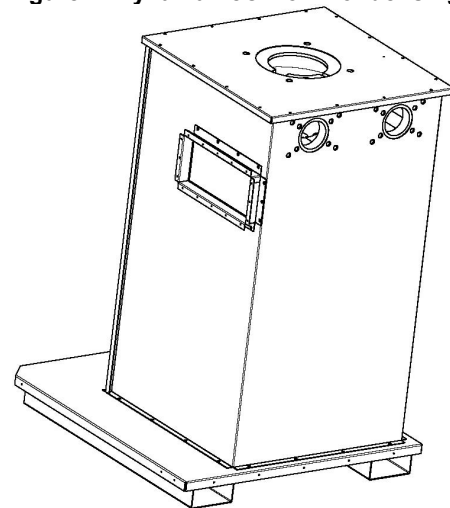

### DynaFlame® Condensing

In this series most of the sensible heat value is being transferred into the water. The unused portion of the sensible heat and most of the latent heat is absorbed by the Condenser Heat Recovery Module (CHRM).

Figure 2: DynaFlame® Condensing

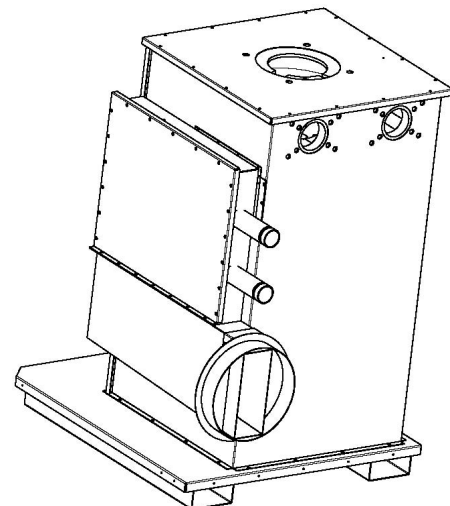

## 1.3 SPECIAL INSTRUCTIONS TO OWNER

This manual supplies information for the installation, operation and servicing of the appliance. It is strongly recommended that this manual be reviewed completely before proceeding with an installation

### CAUTION

It is important that all gas appliances are installed by a competent person. It is in your own interest and that of safety to ensure that all local codes, and all the following "NOTES" and "WARNINGS" is complied with.

To install, service or adjust this appliance, it is imperative that a competent serviceman that is qualified by Camus® Hydronics utilize a combustion analyzer with CO<sub>2</sub>, CO, and draft gauge, to set the appliance according to Camus® Hydronics recommendation, prior to commissioning.

### NOTE

RETAIN THIS MANUAL FOR FUTURE REFERENCE

## 1.4 CHECKING EQUIPMENT

Check for signs of shipping damage upon receiving equipment. Pay particular attention to parts accompanying the boiler, which may show signs of being hit or otherwise being mishandled. Verify total number of pieces shown on packing slip with those actually received. In case there is damage or a shortage, immediately notify carrier.

Figure 3: Checking the DynaFlame®



Do not attempt to pry any panel off. To begin disassembly you must first remove the two ¼” bolts from the top of the lid. Only then will you be able to remove the lid and disassemble the three outer panels.

Once you have removed the lid carefully check and confirm that all ¼” copper tubing connections are intact and have not broken or loosened in shipment. Leaks at any connections on these lines will result in erratic appliance operation.

## 1.5 HOW IT OPERATES (SEQUENCE OF OPERATION)

- Supply power connection as per table 10.
- The power switch is placed in the “ON” position.
- 120 VAC power is supplied to the control transformer.
- 24 VAC is supplied to the ignition module and low voltage controls for all models.
- After the appliance water pump starts, flow is proven by the flow switch. The flow switch is to be mounted in a tee at the outlet of the appliance. Take care to properly trim the flow switch paddles so as not to jam the switch in the tee. The normally open dry contacts in the low water cutoff (LWCO) are to be wired in series with the normally open contacts of the flow switch. Locate the probe type LWCO in the piping above the boiler inlet/outlet connection. The low water cutoff and flow switch are shipped loose. In all cases check with local codes.
- The DynaFlame® controller receives a call for heat via the remote operator contacts and the Demand parameter reads Central Heating or DHW.
- The local thermostat energizes the motor stop/start relay which closes the initiate contacts to the variable frequency drive (VFD) which starts to ramp up the frequency to the 230V 3 phase motor of the

combustion fan. If the VFD is not in fault mode the frequency will accelerate at the preprogrammed rate towards maximum speed using the modulating signal provided by the on board modulating control or the remote operating system.

- If temperature high limit, water flow and airflow switches are closed the fan will run at pre-purge speed until the pre-purge timer is satisfied. Once complete the DynaFlame® will target the ignition fan speed.
- DF 500 – DF 2500 (Direct Ignition):** The hot surface igniter will be energized for 22 seconds followed by energizing the main valve for 4 seconds. A signal of 0.8dVdc must be recognized by the controller at the flame sensor to keep the main gas valve in an open position. The fan is kept at ignition speed until the stabilization timer is satisfied.
- DF 3000 – DF 5000 (Proven Pilot):** The DynaFlame® controller will activate the hot surface igniter for 22 seconds followed by powering the pilot valve for 10 seconds, whereupon a signal of 0.8Vdc must be recognized by the controller at the flame sensor to keep the main gas valve in an open position. The fan is kept at ignition speed until the stabilization timer is satisfied.
- If the flame signal is not reached the module will stop the ignition sequence after the trial for ignition.
- The fan speed will slowly decrease as the heat request nears the heat demand. The modulation rate is controlled via a 4-20mA signal. If the heat demand is sustained for a long duration of time the boiler will get to a point of steady-state and the fan will rotate at constant speed.
- When the heat demand is satisfied or is removed the burner will shut off and the fan speed will ramp up to the preset Post-Purge speed until the Post-Purge timer is satisfied.
- The pump continues to circulate until the post-purge time is satisfied.
- The boiler will then go into Standby as it waits for the next heat demand.

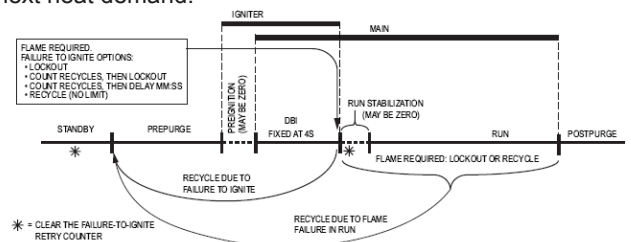

Note:

- If a flame signal is detected at the end of the pre-purge period an error statement to that effect will appear.
- If at the end of the safety period (6 sec) no flame is detected the control will go to post-purge to remove the unburned gas. After this, a re-ignition attempt is started following the same cycle. The number of re-ignition attempts is limited to 2 after which a lockout occurs.
- The burner can only be on continuously for a period of 24 hours. After this the burner is switched off and a restart sequence follows.
- The hot surface igniter is de-energized at the end of the ignition period to allow for ionisation detection.

### 1.6.1 IGNITION PROCESS

- 1 The Ignition module supplies voltage to the Air/Gas Ratio Control Valve.
- 2 Air/Gas Ratio Control Valve senses the pressure differential between the Combustion Air Fan outlet and the vent outlet and supplies gas to the orifice and into the Fan inlet to pre-mix with air.
- 3 The Gas/Air mixture is forced into the Burner and out of the Burner Ports under pressure at soft start input rate.
- 4 Hot Surface Igniter lights the Gas/Air mixture and the Flame Sensor serves as a means to prove Main Burner Flame by rectification.
- 5 Burner is now firing at soft start input rate.
- 6 Variable Frequency Drive adjusts fan speed based on desired water temperature set point or input signal from remote operator 4-20 mA or 2-10VDC signal (must be specified at time of placing order).
- 7 Burner input rate is variable down to approximately 30% of rate or up to 100% of rate as required to satisfy the set point.

### 1.6.2 HEAT TRANSFER PROCESS

- 1 Burner Input continues to increase until water temperature reaches the Set Point temperature.
- 2 Burner Input may stabilize at a fixed rate where demand equals input.
- 3 Burner Input will decrease rate when water temperature approaches temperature Set Point.

### 1.6.3 END OF SEQUENCE

- 1 Set Point temperature is satisfied.
- 2 Power to the gas valves is turned off.
- 3 Combustion Air Fan ramps to a stop over the factory preprogrammed time period of 60 seconds.
- 4 Thermostat is now in a standby mode waiting for the next "Call for Heat".

#### WARNING

To minimize the possibility of serious personal injury, fire or damage to your appliance, never violate the following safety rules.

#### WARNING

**IMPROPER INSTALLATION, ADJUSTMENT, ALTERATION, SERVICE OR MAINTENANCE** can cause injury or property damage. Refer to this manual. For additional information, consult a qualified installer, service agency or gas supplier.

#### DO NOT

Do not use this appliance if any part of it has been **under water**. The possible damage to a flooded appliance can be extensive and present numerous safety hazards. Any appliance that has been **under water** must be replaced

#### WHAT TO DO IF YOU SMELL GAS

Do not try to light any appliance. • Do not touch any electric switch: do not use any phone in your building. • Immediately call your gas supplier from a neighbor's phone. Follow the gas supplier's instructions. • If you cannot reach your gas supplier, call the fire department.

#### IMPORTANT

Consult and follow local Building and Fire Regulations and other Safety Codes that apply to this installation. Contact the local gas utility company to authorize and inspect all gas and flue connections.

**Installation and service must be performed by Camus® qualified factory trained service technicians.**

#### WARNING

Should overheating occur or the gas supply fails to shut off, **DO NOT** turn off or disconnect the electrical supply to the pump. Shut off the gas supply at a location external to the appliance.

#### WARNING

Operation of Non-Condensing DynaFlame® at low fire (less than 100% of input) for long periods of time will increase the possibility of forming condensation in the flue, particularly in Spring/Fall operation.

- Boilers and water heaters are heat producing appliances. To avoid damage or injury, do not store materials against the appliance or the vent-air intake system. Use proper care to avoid unnecessary contact (especially children) with the appliance and vent-air intake components.
- Never cover your appliance, lean anything against it, store trash or debris near it, stand on it or in any way block the flow of fresh air to your appliance.
- **UNDER NO CIRCUMSTANCES** may flammable materials such as gasoline or paint thinner be used or stored in the vicinity of this appliance, vent-air intake system or any location from which fumes could reach the appliance or vent-air intake system.
- A gas appliance that draws combustion air from the equipment room where it is installed must have a supply of fresh air circulating around it during burner operation for proper gas combustion and proper venting.

### 1.7 CODES

The equipment shall be installed in accordance with those installation regulations in force in the local area where the installation is to be made. These shall be carefully followed in all cases. Authorities having jurisdiction shall be consulted before installations are made. In the absence of such requirements, the installation shall conform to the latest edition of the National Fuel Gas Code, ANSI Z223.1 and/or CAN/CGAB149 Installation Code. All electrical wiring must be done in accordance with the requirements of the authority having jurisdiction or, in the absence of such requirements, with National Electrical Code, ANSI/NFPA70 and/or the Canadian Electrical Code part 1 CSA C22.1. Where required by the authority having jurisdiction, the installation must conform to American Society of Mechanical Engineers Safety Code for Controls and Safety Devices for Automatically Fired Boilers, ASME CSD-1. All boilers conform to the latest edition of the ASME Boiler and Pressure Vessel Code, Section II. Where required by the authority having jurisdiction, the installation must comply with the CSA International, CAN/CGA-B149 and/or local codes. This appliance meets the safe lighting performance criteria with the gas manifold and control assembly provided, as specified in the ANSI standards for gas-fired units, ANSI Z21.13.



## 1.8 WARRANTY

- Factory warranty (shipped with unit) does not apply to units improperly installed or improperly operated.
- Factory warranty shall apply only when the appliance is installed in accordance with local plumbing and building codes, ordinances and regulations, the printed instructions provided with it and good industry practices.
- Excessive **water hardness** causing a lime build-up in the copper coils or tubes is not a fault of the appliance and is not covered by warranty. Consult the factory for recommendations for use in hard water areas. (See Water Treatment and Water Chemistry)
- Excessive pitting and erosion on the inside of the copper tube may be an indication of an undersized heater or may be caused by too much **water velocity** through the tubes and is not covered by the manufacturer's warranty (See Boiler Flow Rates and Temperature Rise for flow requirements).
- Using or storing **corrosive chemicals** in the vicinity of this appliance can rapidly attack the copper tubes and coils and voids warranty.
- In case of *Condensing* or *Non-Condensing DynaFlame®*, The Main (Primary) Heat Exchanger is intended to operate under non-condensing conditions. **Inlet water temperatures** must be maintained at 115°F (46°C) or higher for non-condensing models and 130°F (55°C) or higher for near-condensing (DFX) and condensing models. Warranty is void if the Primary heat exchanger is allowed to operate in condensing mode.
- Damage caused by **freezing or dry firing** voids warranty.
- This appliance is not to be used for **temporary heating** of buildings under construction.
- The manufacturer shall **NOT** be held liable for any personal injury or property damage due to ice formation or the dislodging of ice from the vent system or the vent termination

## 1.9 REMOVAL OF EXISTING APPLIANCE

When an existing appliance is removed from a common venting system, the common venting system is likely to be too large for proper venting of the appliances remaining connected to it. At the time of removal of an existing appliance, the following steps must be followed with each appliance remaining connected to the common venting system placed in operation, while the other appliances remaining connected to the common venting system are not in operation.

- Seal any unused openings in the common venting system.
- Visually inspect the venting system for proper size and horizontal pitch and determine that there is no blockage, restriction, leakage, corrosion or other deficiency, which could cause an unsafe condition.
- Insofar as is practical, close all building doors and windows and all doors between the spaces in which the appliances remaining connected to the common venting system are located and other spaces of the building. If applicable turn on the clothes dryers and any appliances not connected

to the common venting system. Turn on any exhaust fans, such as range hoods and bathroom exhausts, so they will operate at maximum speed. Do not operate a summer exhaust fan. Close fireplace dampers.

- Place in operation the appliance being inspected. Follow the lighting instructions. Adjust thermostat so that appliance operates continuously.
- If provided, test for spillage at the draft control device relief opening after 5 minutes of main burner operation. Use a cold mirror, the flame of a match, or candle or smoke from a cigarette.
- Test for spillage at the draft control device relief opening after 5 minutes of main burner operation.
- After it has been determined that each appliance remaining connected to the common venting system properly vents when tested as outlined above, return doors, windows, exhaust fans, fireplace dampers and any other gas-burning appliance to their previous condition of use.
- Any improper operation of the common venting system should be corrected so that the installation conforms to the National Fuel Gas Code, ANSI Z223.1 and/or CAN/CGA B149, Installation Codes. When resizing any portion of the common venting system, the common venting system should be resized to approach the minimum size as determined using the appropriate tables in Part 11 of the National Fuel Gas Code, ANSI Z223.1 and/or CAN/CGA B149, Installation Codes.

Heat exchanger surfaces and vent piping should be checked every six months for deterioration and carbon deposits. Remove all soot or other obstructions from the chimney and flue, which might impede draft action. Replace any damaged or deteriorated parts of the venting system.

A qualified service technician should follow this procedure when inspecting and cleaning the heat exchanger and vent pipe.

1. Turn off electrical power and main manual gas shut-off and allow appliance to cool down.
2. Remove the vent pipe running to the chimney and check heat exchanger, vent and chimney for obstruction and clean as necessary.
3. Remove burner from appliance and carefully clean as required. Never brush or wipe the knitted metal fiber surface, use a garden hose and wash instead. **Caution: Never use pressure washer to clean the burner.**
4. Use pressure wash to clean heat exchanger if necessary.
5. Reinstall parts removed in steps 2 and 3. Be sure that vent pipe has proper pitch and is properly sealed. Replace any damaged gasket. Note that the burner is supplied with two gaskets; a high temperature ceramic paper gasket under the burner flange and a stamped silicon gasket between the burner flange and fan flange. Tighten fan flange mounting nuts to 20 ft-lb.
6. Restore electrical power and gas supply to appliance.
7. Place appliance in operation using lighting instructions provided.
8. Confirm proper operation of all safety devices
9. Check for gas leaks and proper vent operation.

**NOTE:**

Experience has shown that improper installation or system design, rather than faulty equipment, is the cause of most operating problems

**1.10 BOILER ROOM OPERATING CONDITION**

- Due to low jacket losses from the appliance, temperatures in a typical boiler room may drop significantly; supplemental heat is required to maintain ambient temperature at acceptable levels.
- Cold fresh air intakes must be located to minimize the effects on venting and subsequent condensation in the flue of Category I installations. When necessary, consider the use of insulation or corrosion resistant venting material.
- Camus® DynaFlame® boilers and water heaters are approved at 85% efficiency which allows the equipment to be vented as a Category I appliance using either single wall “C” vent or double wall “B” vent. Certain conditions in the field however lead to condensation in the vent and render these products unsuitable.

These conditions include and are not necessarily limited to:

1. Low boiler room temperature.
2. Low return water temperature.
3. Long periods of low fire operation.
4. Oversized breeching in common venting applications.
5. Proximity to combustion air openings.

Given the frequency of these conditions occurring in the field, we are recommending the use of corrosion resistant stainless steel venting wherever possible.

**1.11 CLEARANCE FROM COMBUSTIBLE MATERIAL**

This appliance is suitable for alcove (a closet without a door) installation with minimum clearances to combustibles as follows:

**Table 1: Clearances from Combustibles**

Clearances from Combustibles	
TOP:	12"
SIDES:	12"
REAR:	12"
VENT:	6"

**Figure 4: Clearance from Combustibles**

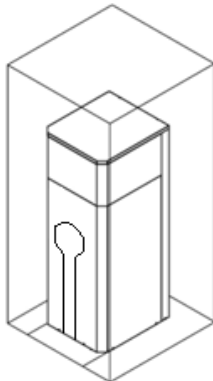

When placing the appliance be aware that a minimum clearance of 24" (60cm) must be provided at the front to allow easy access to the primary heat exchanger.

**NOTE:** Clearances from combustible construction are noted on the appliance rating plate

When installed directly on combustible flooring, the appliance shall be installed on a metal panel extending beyond the full width and depth of the appliance by at least 3 inches (76.2mm) in any direction. The floor must be strong enough to support the full weight of the heater.

Maintain minimum specified clearances for adequate operation. All installations must allow sufficient space for servicing the vent connections, water pipe connections, circulating pump, bypass piping and other auxiliary equipment, as well as the appliance

**Table 2: Service Clearances**

Service Clearances					
Model Numbers	Service Clearance, Inches (cm)				
	Top	Right Side	Left Side	Back	Front
500	24" (60cm)	12" (30cm)	12" (30cm)	*	24" (60cm)
750	24" (60cm)	12" (30cm)	12" (30cm)	*	24" (60cm)
1100	24" (60cm)	12" (30cm)	12" (30cm)	*	24" (60cm)
1200	24" (60cm)	12" (30cm)	12" (30cm)	*	24" (60cm)
1500	24" (60cm)	12" (30cm)	12" (30cm)	*	24" (60cm)
1750	24" (60cm)	12" (30cm)	12" (30cm)	*	24" (60cm)
2000	24" (60cm)	12" (30cm)	12" (30cm)	*	24" (60cm)
2500	24" (60cm)	12" (30cm)	12" (30cm)	*	24" (60cm)
3000	24" (60cm)	12" (30cm)	12" (30cm)	*	24" (60cm)
3500	24" (60cm)	12" (30cm)	12" (30cm)	*	24" (60cm)
4000	30" (77cm)	12" (30cm)	12" (30cm)	*	24" (60cm)
4500	35" (89cm)	12" (30cm)	12" (30cm)	*	24" (60cm)
4504	20" (51cm)	12" (30cm)	12" (30cm)	*	24" (60cm)
5000	40" (102cm)	12" (30cm)	12" (30cm)	*	24" (60cm)
5004	24" (60cm)	12" (30cm)	12" (30cm)	*	24" (60cm)
6004	33" (84cm)	12" (30cm)	12" (30cm)	*	24" (60cm)

\*Allow adequate space for the venting in addition to 6" clearance to combustibles.

## 1.12 **INSTALLATION PROCEDURE AND LOCATION OF UNIT**

Install this appliance in a clean, dry location with adequate air supply and close to a good vent connection.

- Do not locate this appliance in an area where it will be subject to freezing unless precautions are taken. Radiant losses from the DynaFlame® are minimal and should not be relied on to keep the appliance room warm. If the appliance is installed in a cold room and/or on a cold floor, isolating the appliance from the cold floor and heating the room is recommended.

- The appliance should be located close to a floor drain in an area where leakage from the appliance or connections will not result in damage to the adjacent area or to lower floors in the structure, it is recommended that a suitable drain pan, adequately drained, be installed under the unit. Under no circumstances is the manufacturer to be held responsible for water damage in connection with this unit, or any of its components.

If the appliance is installed above the level of the building's radiation system, a low water cut-off device must be installed above the heat exchanger inlet/outlet connections. Some local codes require the installation of a low water cut-off on all systems

- When placing the appliance be aware that a minimum clearance of 24" must be provided at the front to allow easy access to the primary heat exchanger. Non-condensing units do not require access through both sides and could be placed adjacent to each other with zero clearance. For condensing units a minimum clearance of 12" must be provided on the right side for access to the Condensing Heat Recovery Module.
- The appliance must be installed so that the ignition system components are protected from water (dripping, spraying, etc.) during appliance operation and service (circulator replacement, control replacement, etc.)
- Appliances located in a residential garage and in adjacent spaces that open to the garage and are not part of the living space of a dwelling unit must be installed so that all burners and burner ignition devices have a minimum clearance of not less than 18" (46cm) above the floor. The appliance must be located or protected so that it is not subject to physical damage by a moving vehicle.
- **DO NOT** install this appliance in any location where gasoline or flammable vapors are likely to be present.
- Appliance must be installed on a level floor. Maintain required clearances from combustibile surfaces.
- The appliance designed for indoor installation (Indoor Models) must be installed indoors where it is protected from exposure to wind, rain and weather.

The appliance designed for outdoor installation (Outdoor Models) must be installed outdoors. For outdoor installations, always consider the use of a shelter such as a garden shed in lieu of direct exposure of the appliance to the elements. The additional protection afforded by the shelter will help to minimize nuisance problems with electrical connections and will allow easier servicing of the appliance under severe weather conditions.

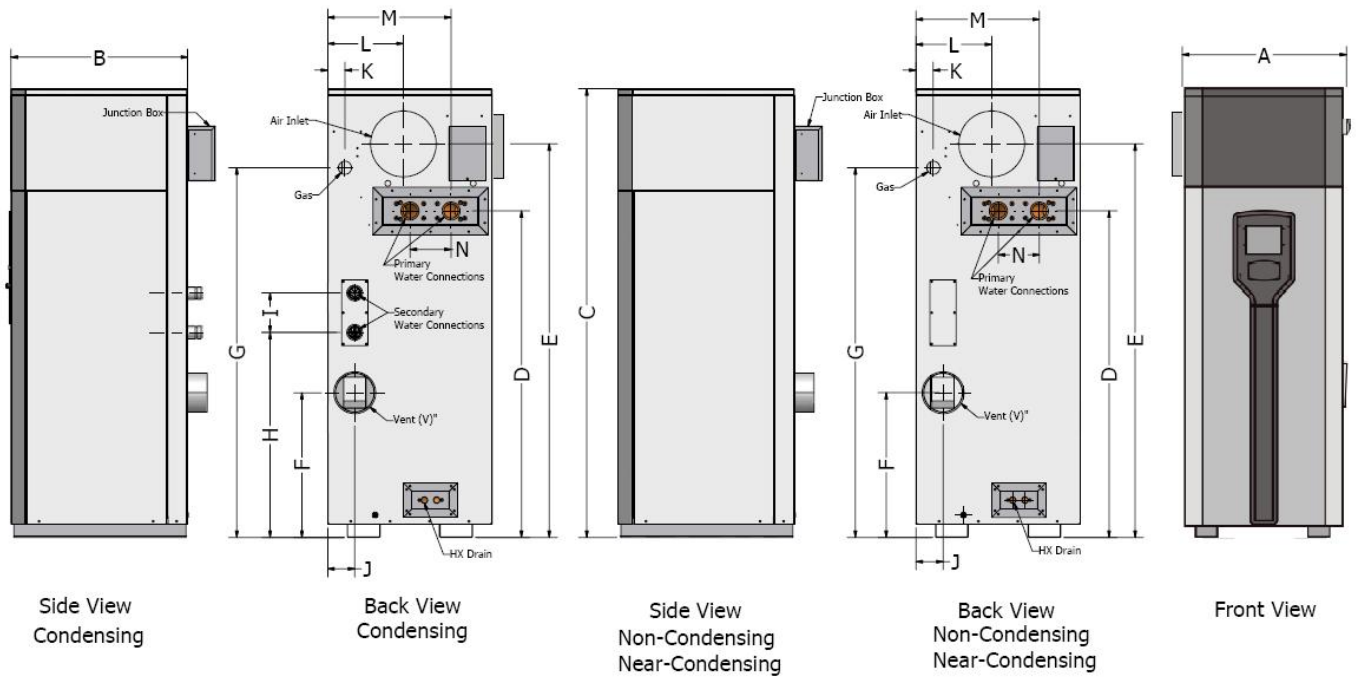

**Table 3: Appliance Dimensions and Specifications [in.]**

Model	Width "A"	Depth "B"	Height "C"	Water Conn. "D"	Air Inlet "E"	Flue Height "F"	Gas Height "G"	"H"	"I"	"J"	"K"	"L"	"M"	"N"	Air Inlet Dia. "W" [T.P.]	Water Conn. Prim. [T.P.]	Water Conn. Sec. Grooved (Optional) [T.P.]	Gas Conn. [NPT, T.P.]
500	25	27	45 5/8	27	37 1/4	13 1/4	33 5/8	17 3/4	6	4 1/8	2 5/8	11 1/2	18 3/4	6 1/4	10	2	1 1/2	1
750	25	27	55	36 3/8	46 5/8	15 3/4	43	25	6	4 1/8	2 5/8	11 1/2	18 3/4	6 1/4	10	2	1 1/2	1
1100	25	27	68 1/4	49 5/8	59 7/8	22	56 1/4	31 1/8	6	4 1/8	2 5/8	11 1/2	18 3/4	6 1/4	10	2	1 1/2	1
1200	25	27	68 1/4	49 5/8	59 7/8	22	56 1/4	31 1/8	6	4 1/8	2 5/8	11 1/2	18 3/4	6 1/4	10	2	1 1/2	1
1500	29 3/8	31 3/4	58 1/8	38 1/4	48 5/8	16 3/8	45 7/8	24 1/2	6	3 7/8	1 7/8	13 1/2	22 3/8	10 1/4	10	2 1/2	1 1/2	1 1/4
1750	29 3/8	31 3/4	62 5/8	42 5/8	53 1/8	16 3/8	50 3/8	24 1/2	6	3 7/8	1 7/8	13 1/2	22 3/8	10 1/4	10	2 1/2	1 1/2	1 1/4
2000	29 3/8	31 3/4	66 7/8	46 7/8	57 3/8	20	53 5/8	28 3/4	6	3 7/8	1 7/8	13 1/2	22 3/8	10 1/4	12	3	1 1/2	1 1/4
2500	29 3/8	31 3/4	73 1/2	52 5/8	63 5/8	25 3/4	60 3/8	34 1/2	6	3 7/8	1 7/8	13 1/2	22 3/8	10 1/4	12	3	1 1/2	1 1/2
3000	29 3/8	31 3/4	79 1/2	58 5/8	69 5/8	31 3/4	66 3/8	40 1/2	6	3 7/8	1 7/8	13 1/2	22 3/8	10 1/4	12	3	1 1/2	1 1/2
3500	29 3/8	31 3/4	86 1/2	63 5/8	76	24 7/8	72 5/8	32 7/8	20	3 7/8	1 7/8	13 1/2	22 3/8	10 1/4	14	4	1 1/2	2
4000	29 3/8	31 3/4	91 1/2	68 5/8	81	29 7/8	77 5/8	32 7/8	20	3 7/8	1 7/8	13 1/2	22 3/8	10 1/4	14	4	1 1/2	2
4500	29 3/8	31 3/4	96 1/2	73 5/8	86	34 7/8	82 5/8	42 7/8	20	3 7/8	1 7/8	13 1/2	22 3/8	10 1/4	14	4	1 1/2	2 1/2
5000	29 3/8	31 3/4	101 1/2	78 5/8	91	39 7/8	87 5/8	47 7/8	20	3 7/8	1 7/8	13 1/2	22 3/8	10 1/4	14	4	1 1/2	2 1/2
4504	35 3/4	39 1/4	83	59 3/4	72 1/4	20 3/4	67 7/8	28 7/8	20	2 1/2	3 1/2	17 7/8	25 5/8	12	14	4	1 1/2	2 1/2
5004	35 3/4	39 1/4	88 1/4	65	77 1/2	26	72 1/4	34 1/8	20	2 1/2	3 1/2	17 7/8	25 5/8	12	14	4	1 1/2	2 1/2
6004	35 3/4	39 1/4	102	75 1/2	91	35 1/2	85 1/2	44 5/8	20	2 1/2	2 3/4	17 7/8	25 5/8	12	14	4	1 1/2	3

Copper and copper nickel heat exchanger  
 500 – 1200 appliance inlet/outlet connections are 2" NPT  
 1500 – 5000 appliance inlet/outlet connections are 3" NPT

Stainless steel heat exchanger:  
 500 – 1200 appliance inlet/outlet connections are 2" groove lock  
 1500 – 2500 appliance inlet/outlet connections are 2-1/2" groove lock  
 3000 - 5000 appliance inlet/outlet connections are 3" groove lock  
 4504 - 6004 appliance inlet/outlet connections are 4" groove lock

**Table 4: Vent Sizes for a Single Appliance**

DynaFlame® Non-Condensing				
Model	Vent Diameter Inches			
	Outdoor	Cat III Up to 50 ft	Cat III Up to 100 ft	Cat I
0500	4	4	6	8
0750	6	6	8	10
1100	6	6	8	10
1200	6	6	8	10
1500	7	7	10	12
1750	7	7	10	12
2000	8	8	12	14
2500	8	8	12	14
3000	8	8	12	14
3500	9	9	14	16
4000	9	9	14	16
*4500	10	10	14	16
4504	10	10	14	16
*5000	10	10	14	16
5004	10	10	14	16
6004	12	12	14	16

DynaFlame® Near-Condensing (DFX)				
Model	Vent Diameter Inches			
	Outdoor	Cat IV Up to 50 ft	Cat IV Up to 100 ft	Cat II
0501	4	4	6	5
0751	6	6	8	6
1101	6	6	8	7
1201	6	6	8	7
1501	7	7	10	8
1751	7	7	10	8
2001	8	8	12	9
2501	8	8	12	9
3001	8	8	12	10
3501	9	9	14	12
4001	9	9	14	12
*4501	10	10	14	12
4514	10	10	14	12
*5001	10	10	14	12
5014	10	10	14	12
6014	12	12	14	12

DynaFlame® Condensing				
Model	Vent Diameter Inches			
	Outdoor	Cat IV Up to 50 ft	Cat IV Up to 100 ft	Cat II
0502	4	4	6	5
0752	6	6	8	6
1102	6	6	8	7
1202	6	6	8	7
1502	7	7	10	8
1752	7	7	10	8
2002	8	8	12	9
2502	8	8	12	9
3002	8	8	12	10
3502	9	9	14	12
4002	9	9	14	12
*4502	10	10	14	12
4524	10	10	14	12
*5002	10	10	14	12
5024	10	10	14	12
6024	12	12	14	12

## PART 2 AIR SUPPLY & VENTING

### ⚠ DANGER

It is extremely important to follow these venting instructions carefully. Failure to do so can cause severe personal injury, death or substantial property damage.

### ⚠ DANGER

Foam Core Pipe, PVC, CPVC are not to be used in any part of the venting system.

### 2.1 GENERAL VENTING GUIDE

Figure 5: Venting Configurations

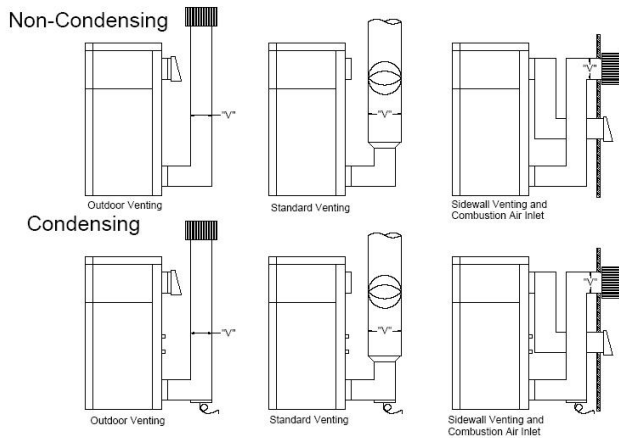

The DynaFlame® is a category I, 85% efficient unit, supplied as a non-condensing appliance.

- When supplied with the Condenser Heat Recovery Module (CHRM). The DynaFlame® is 95% efficient and is considered to be a category II appliance.
- Provisions for combustion and ventilation air are to be in accordance with the section "Air for Combustion and Installation", Of the National Fuel Gas Code, ANSI Z223.1/NFPA 54, or clause 8.2, 8.3, 8.4 of "Natural Gas and Propane Installation Code", CAN/CSA B149.1.2, or appliance provisions of the local building codes.
- The distance of the vent terminal from adjacent buildings, windows that open and building openings MUST comply with the latest edition of the National Fuel Gas Code, ANSI Z223.1, in Canada, the latest edition of CAN/CGA Standard B149 Installation Code for Gas Burning Appliances and Equipment.
- Vent connection is made directly to the flue outlet opening on the back of the unit. The connection from the appliance vent to the stack must be made as direct as possible.
- Appliances for outdoor installation are intended to vent using a listed vent cap. For indoor installations venting must be in accordance with Part 7, Venting of Equipment, of the National Fuel Gas Code, ANSI Z223.1, or Section 7, Venting of Equipment and Air Supply for Appliances, of the CAN/CGA B149, Installation Codes, or applicable provisions of the local building codes.
- Vent connectors serving appliances vented by natural draft shall not be connected into any portion of mechanical draft systems operating under positive pressure.
- Horizontal runs of vent pipe shall be securely supported (approximately every 4 feet) to prevent sagging and maintain a minimum upward slope of 1/4" per foot from the

appliance to the vent terminal.

- The weight of the venting system must not rest on the unit. Adequate support of the venting system must be provided in compliance with local codes and other applicable codes.
- All connections should be secured and sealed per the vent manufacturer's specifications. When a Positive vent system is disconnected for any reason, the flue must be reassembled and resealed according to the vent manufacturer's instructions.
- Do not use an existing chimney as a raceway if another appliance or fireplace is vented through the chimney.

#### 2.1.1 CATEGORY I AND CATEGORY III VENTING

A Category I or III venting system for the flue products is required on all non-condensing models (DynaFlame® without CHRM). A Category I venting system operates with a negative pressure in the vent. The Category III venting system operates with positive pressure generated by the internal combustion air fan.

- The Category I flues from multiple appliances can be combined into a common vent using recommendations from published venting tables.
- Controls of single or multiple Category I appliances may subject appliances to low fire operation for long periods depending on control strategies being used. Under this condition the venting does not reach the temperatures required for evaporation of flue gas condensation generated from initial start-up. To prevent nuisance condensation, avoid this operating condition or use corrosion resistant stainless steel venting.
- The Category III flues from multiple appliances **CAN NOT** be combined into a common vent.
- The Category III flue must be a dedicated stack.
- The Category III Flue appliance must have all vent joints and seams gas-tight. Unless a special venting system made from AL29-4C or equivalent is used which has integral seals, all vent connector seams and joints must be sealed with pressure sensitive aluminium tape or silicone sealant as specified by the vent manufacturer. Aluminium tape must meet the provisions of SMACNA AFTS -100-73 Standard.
- The flue products in a category III vent system may be cooled below their dew point and form condensate in the flue. Corrosion resistant stainless steel must be used for the venting.
- When venting category III appliance thru unheated spaces insulation should be wrapped around single wall vent pipe to minimize the possibility of flue gas condensation inside the vent unless AL29-4C or equivalent special venting is used. The authorities have jurisdiction must approve venting prior to insulating.
- The flue from a Category III vent system must have provisions to properly collect and dispose of any condensate that may occur in the venting system.

#### 2.1.2 VENTING GUIDELINES FOR CATEGORY III VENTING

- The installed length of the positive pressure category III flue from the appliance to the point of termination, outside of the building, must not exceed a maximum

of 100 equivalent feet (30.5 m) in length. Depending on diameter and centreline radius subtract from 7 to 19 feet per 90° elbow using published data. Subtract half this value for each 45° elbow.

- The flue may terminate either vertically at the roof top or horizontally on a THRUWALL. See the information about the specific vent termination location for recommended location and clearances.

### 2.1.3 CATEGORY II AND CATEGORY IV VENTING

A Category II or IV venting system for the flue products is required on all condensing models (DynaFlame® with CHRM). A Category II venting system operates with a negative pressure in the vent.

The Category IV venting system operates with positive pressure generated by the internal combustion air fan which operates the combustion process and also exhausts the flue products from the building.

- The Category II flues from multiple appliances can be combined into a common vent, this special venting system must be engineered by venting manufacturer and to be approved by local authority.
- The Category IV flues from multiple appliances **CAN NOT** be combined into a common vent.
- The Category IV flue must be a dedicated stack.
- The Category IV Flue appliance must have all vent joints and seams sealed gas-tight
- The flue products in the vent system will be cooled below their dew point and form condensate in the flue and must use AL29-4C material.
- The flue from a Category II and IV vent system must have a condensate drain with provisions to properly collect, neutralize and dispose of any condensate that may occur.

### 2.1.4 VENTING GUIDELINES FOR CATEGORY IV VENTING

- The installed length of the Positive pressure category IV flue from the appliance to the point of termination, outside of the building, **must not exceed a maximum of 100 equivalent feet (30.5M) in length.** Depending on diameter and centerline radius subtract from 7 to 19 feet per 90° elbow using published data. Subtract half this value for each 45° elbow.
- For Category IV site conditions exceeding 100 equivalent feet an engineered vent system approved by the local authority will be required.
- The flue may terminate either vertically at the roof top or horizontally on a THRUWALL. See the information about the specific vent termination location for recommended location and clearances.

### 2.1.5 APPROVED VENTING MATERIALS

#### Exhaust Vent for Use for DynaFlame® Non-condensing Category I Installations

- 1 "B" type.
- 2 Stainless Steel Single Wall (required when operating appliance at low fire for long periods).
- 3 "C" Vent. (Canada ONLY)
- 4 Equivalent or higher rated than above

#### Exhaust Vent for Use for DynaFlame® Non-condensing Category III Installations

- 1 Corrosion resistant stainless steel single wall.
- 2 AL29-4C or equivalent, single or double wall.

#### Exhaust Vent for Use for DynaFlame® Condensing Category II or IV Installations

- 1 AL29-4C or equivalent, Single or Double Wall.
- 2 "BH" type.

#### Vent material selection for condensing and near condensing applications

Camus® condensing and near condensing boilers/water heaters are category II or IV appliances and the exhaust vent material must be UL/ULC listed for use with category IV appliances operating under positive pressure in condensing flue gas service.

Currently, manufactured prefabricated UL/ULC listed vents of AL29-4C or 316L stainless steel must be used with the Camus® condensing and near condensing boiler/water heaters.

NOTE	
1)	Use of cellular core PVC (ASTM F891), cellular core CPVC or Radel® (polyphenosulfone) in venting systems is prohibited.
2)	Covering non-metallic vent pipe and fittings with thermal insulation is prohibited.

When selecting vent material take into consideration that appliances installed near a corrosive or potentially corrosive air supply must be isolated from it or they will suffer damage to the appliance and the venting system.

The corrosion resistance of AL29-4C is typically higher than that of 316L. Always choose the venting system which best satisfies the requirements of the application.

***This recommendation does not supersede local codes or the provision of the B149 in Canada or the National Fuel Gas Code in the United States***

#### Intake Air (Supply Air, or Fresh Air) Piping

- 1 **PVC** Non Foam Core Pipe.
- 2 **CPVC** (Chlorinated Polyvinyl Chloride).
- 3 **ABS** (Acrylonitrile-Butadiene-Styrene).
- 4 **Single wall**, galvanized, stainless steel

Single wall vent pipes are to be insulated 5 feet from wall toward the interior of the building to minimize external sweating.

### 2.1.6 VENT TERMINATION CLEARANCES

- Do not terminate the vent in a window well, stairwell, alcove, courtyard or other recessed area. The vent cannot terminate below grade. The bottom of the vent terminal shall be located at least 12 inches (30cm) above grade and above normal snow levels. In all cases the appliance shall be installed in accordance with local codes.
- To avoid a blocked flue condition, keep the vent cap/terminal clear of snow, ice, leaves, debris, etc.
- Flue gases from this appliance may contain large amounts of water vapour that will form a white plume in winter. Plume could obstruct a window view.

- Flue gas condensate can freeze on exterior walls or on the vent cap. Frozen condensate on the vent cap can result in a blocked flue condition. Some discoloration to exterior building surfaces can be expected. Adjacent brick or masonry surfaces should be protected with a rust resistant sheet metal plate.

### 2.1.7 INLET CAP FOR ROOFTOP TERMINATION

The air inlet cap consists of two 90° elbows installed at the point of termination for the air inlet pipe. The first 90° elbow is installed on the rooftop at the highest vertical point of the air inlet pipe and turned horizontal; the second 90° elbow is screened and is installed on the horizontal outlet of the first elbow and turned down. A 90° elbow and a 90° street elbow may be used to make this assembly. If a straight piece of pipe is used between the two elbows, it should not exceed 6" (150mm) in length.

### 2.1.8 LOCATION OF A ROOFTOP AIR INLET AND VENT CAPS

- The point of termination for the combustion air inlet cap MUST be at least 3 feet (0.91M) below the point of flue gas termination (vent cap) if it is located within a 5 foot (1.5M) radius of the flue outlet. Use care to ensure that the 90° elbow assembly is properly installed on the air inlet pipe.
- The termination point of the combustion air inlet cap must be installed at least 3 feet (0.91M) above the rooftop and above normal snow levels.
- The vent cap assembly MUST be listed by nationally recognized agencies.
- Combustion air supplied from outdoors must be free of contaminants. To prevent recirculation of flue products in to the combustion air inlet, follow all instructions in this section.
- Incorrect installation and/or location of the air inlet cap can allow flue products to be drawn back into the appliance. This can result in incomplete combustion and potentially hazardous levels of carbon monoxide in the flue products. This will cause operational problems with the appliance and if left uncorrected, will lead to conditions that can cause personal injury or death.

### 2.1.9 AIR INLET DAMPER

In warmer climates, during cold weather, the use of ducted outdoor air may result in the formation of condensation on the interior panels of the combustion chamber. It may be possible for this condensation to accumulate and drip out of the appliance jacket. If this is not acceptable, it is advisable to install a motorized combustion air damper in the combustion air duct interlocked with the appliance's start circuit. In cold climates it is essential to provide a motorized air inlet damper to control the supply of combustion air and prevent nuisance condensation.

**Figure 6: Air Inlet Damper Connection Inside J-Box**

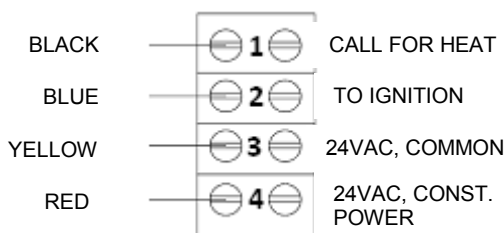

### 2.1.10 MASONRY CHIMNEY INSULATIONS

Always follow local codes when venting this appliance into a masonry chimney. A standard masonry chimney must NOT be used to vent the products of combustion from the flue of a condensing, positive or negative pressure appliance (Category II or IV). If a masonry chimney is to be used, the chimney MUST use a sealed, metallic, corrosion resistant liner system to vent flue products from this high efficiency appliance. Sealed, metallic, corrosion resistant liner systems (AL29-4C or equivalent, single wall or double-wall, or flexible or rigid metallic liners) must be rated for use with a high efficiency condensing, positive pressure vent system. Corrosion resistant chimney liner systems are typically made from a high grade of corrosion resistant stainless steel such as AL29-4C or equivalent. The corrosion resistant liner must be properly sized and fully sealed throughout the entire length. If the flue is contained within the masonry chimney both the top and the bottom of the masonry chimney must be capped and sealed to provide a dead air space around the sealed corrosion resistant metallic liner.

**Consult with local code officials to determine code requirements or the advisability of using a masonry chimney with a sealed corrosion resistant liner system.**

### 2.1.11 VERTICAL VENTING TERMINATION

- Follow Category II or IV vent termination and all general instructions.
- The vent terminal should be vertical and exhaust outside the building at least 2 feet (0.61m) above the highest point of the roof within a 10 foot (3.05m) radius of the termination.
- The vertical termination must be a minimum of 3 feet (0.91m) above the point of exit.
- A vertical termination less than 10 feet (3.05m) from a parapet wall must be a minimum of 2 feet (0.61m) higher than the parapet wall.

### 2.1.12 COMBINED COMBUSTION AIR INLET

The air inlet pipes from multiple appliances can be combined to a single common connection if the common air inlet pipe has a cross sectional area equal to or larger than the total area of all air inlet pipes connected to the common air inlet pipe.

Equivalent pipe diameter = Sq Root [(d<sub>1</sub>)<sup>2</sup> + (d<sub>2</sub>)<sup>2</sup> + (d<sub>3</sub>)<sup>2</sup> + (d<sub>4</sub>)<sup>2</sup> + ..... + (d<sub>n</sub>)<sup>2</sup>], d, pipe diameter

❖ Example: What is equivalent pipe diameter of three air inlet pipes, 8" (20.3 cm), 10" (25.4 cm) and 12" (30.5 cm)

Equivalent pipe diameter = Sq Root [(8)<sup>2</sup> + (10)<sup>2</sup> + (12)<sup>2</sup>] = Sq Root (308) = 17.5", Select 18" (82.8 cm) diameter pipe or larger.

The air inlet point for multiple boiler air inlets must be provided with an exterior opening which has a free area equal to or greater than the total area of all air inlet pipes connected to the common air inlet. This exterior opening for combustion air must connect directly to the outdoors. The total length of the combined air inlet pipe must not exceed a maximum of 100 ft. (30.5M) equivalent feet. You must deduct the restriction in area provided by any screens, grills or louvers installed in the common air inlet point. Screens, grills or louvers installed in the common air inlet can reduce the free area of the opening from 25% to 75% based on the materials used. Calculate and

compensate accordingly for the restriction.

### 2.1.13 DRAIN TEE

Figure 7: Drain “T” and Neutralizer Cartridge Installation

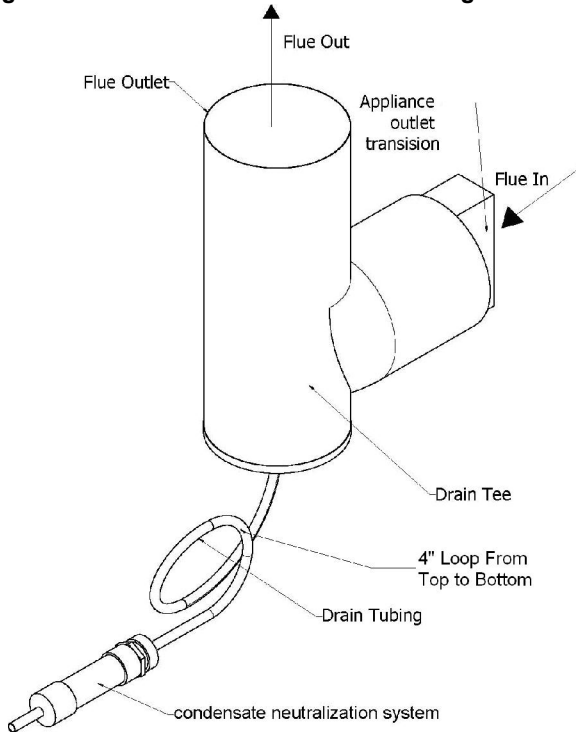

A drain tee **MUST** be installed in the Condensing vent pipe to collect and dispose of any condensate that may occur in the vent system. The drain tee should be installed at the point where the flue turns vertical for a roof top termination or as one of the first fittings in a horizontal flue that will terminate on a THRUWALL. Ensure that horizontal portions of the vent are properly sloped to allow condensate to be evacuated at the drain tee. Plastic drain tubing, sized per the vent manufacturer's instructions, shall be provided as a drain line from the tee. The drain tubing must have a trap provided by a 4" (10cm)-diameter circular trap loop in the drain tubing. Prime the trap loop by pouring a small quantity of water into the drain hose before assembly to the vent. Secure the trap loop in position with nylon ties. Use caution not to collapse or restrict the condensate drain line with the nylon wire ties. The condensate drain must be routed to the condensate neutralization system or a suitable drain for disposal of condensate that may occur in the vent system.

Ensure that the drain from the condensate tee is not exposed to freezing temperature.

## 2.2 CONVENTIONAL VENTING (INDOOR) INSTALLATIONS

### • NON – CONDENSING

• The DynaFlame® non-condensing is a category I appliance and is approved for venting into a common standard chimney. On single appliance installations with dedicated chimney if drafts are excessive (above negative 0.15 Inches W.C.), install a single acting barometric damper directly past the appliance's flue outlet. A minimum draft of 0.05 Inches W.C is required for operation. This damper will control excessive draft & minimize standby losses.

- Multiple appliances may be vented into a conventional chimney. The chimney must be lined. And a single acting barometric damper must be provided for each appliance. Vent diameters are to be increased over and above those recommended in Table 5.
- The chimney must be protected from down drafts, rain and debris by using a listed chimney cap.
- If the appliance is located in a room maintained at low temperature and is being run for extended periods of time at low fire it is likely that condensation will be formed in the vent. Consideration must be given to heating the room or providing a special venting system similar to that used for condensing appliance application

### • CONDENSING

- The DynaFlame® condensing version is a category II appliance and is approved for venting into a common properly designed chimney. On single appliance installations with dedicated chimney, if drafts are excessive (above negative 0.15 Inches W.C.), we recommend a single acting barometric damper.
- A qualified professional using a proven vent-sizing program with input of accurate operating parameters must properly do sizing of the venting system. In applications where flue gas temperatures are lower than can support a Category II with conventional negative draft, it will be determined at the venting design stage that a positive pressure will be developed in the vent. It will then be necessary to either provide separate vents as for Category IV, pressurize the room or to provide an extractor at the chimney outlet interlocked with the appliance operating circuit in order to maintain a negative draft in the chimney and allow common venting.
- Approval of the installation will be at the discretion of authorities having jurisdiction.

### • IN GENERAL

- The operation of exhaust fans, compressors, air handling units etc. can rob air from the room, creating a negative pressure condition leading to reversal of the natural draft action of the venting system. Under these circumstances an engineered air supply is necessary.
- If the appliance is to be installed near a corrosive or potentially corrosive air supply, the appliance must be isolated from it and outside air should be supplied as per code.
- Potentially corrosive atmospheres will result from exposure to permanent wave solution, chlorinated waxes and cleaners, chlorine, water softening chemicals, carbon tetrachloride, halogen based refrigerants, Freon cleaning solvents, hydrochloric acid, cements and glues, masonry washing materials, antistatic fabric softeners, dry cleaning solvents, degreasing liquids, printing inks, paint removers, etc.
- The equipment room **MUST** be provided with properly sized openings to assure adequate combustion air and proper ventilation when the unit is installed with a proper venting system.



### 2.2.1 AIR REQUIRED FOR COMBUSTION AND VENTILATION

Provisions for combustion and ventilation air are to be in accordance with the section for "Air for Combustion and Ventilation", of the National Fuel Gas Code, ANSI Z223.1/NFPA 54, or clause 8.2, 8.3, 8.4 of "Natural Gas and Propane Installation Code", CAN/CSA B149.1.2, or applicable provisions of the local building codes.

If air is taken directly from outside the building with no duct, provide two permanent openings:

- a) Ventilation of the space occupied by fuel burning appliance(s) or equipment shall be supplied by a ventilation opening at the highest practicable point communicating with the outdoors. The total cross sectional area of the ventilation opening must be either 10% of the net free area required for combustion air or 10 sq. in (6500 mm<sup>2</sup>), whichever is greater.
- b) Net free area of combustion air opening shall be in accordance with all applicable codes. In the absence of such codes provide combustion air opening with a minimum free area of one square inch per 7,000 Btuh input (5.5 cm per kW) up to 1,000,000 Btuh and one square inch per 14,000 Btuh in excess of 1,000,000 Btuh. This opening must be ducted no higher than 18" nor less than 6" above the floor.
- c) In extremely cold climates when air supply is provided by natural air flow from the outdoors we recommend sizing the combustion air supply opening with a minimum free area of not less than one square inch per 30,000 Btu/hr, of the total rated input of the burner, provided that this does not conflict with local codes. This opening is in addition to the ventilation opening defined in paragraph a) above.

#### NOTE

Outside air openings shall directly communicate with the outdoors.

#### CAUTION

Under no circumstances should the mechanical room ever be under a negative pressure. Particular care should be taken where exhaust fan, attic fans, clothes dryers, compressors, air handling units, etc., may take away air from the unit.

### 2.2.2 EXHAUST FANS

Any fan or equipment which exhausts air from the equipment room may deplete the combustion air supply and/or cause a downdraft in the venting system through a barometric damper if installed. Spillage of flue products from the venting system into an occupied living space can cause a very hazardous condition that must be immediately corrected.

### 2.3 OUTDOOR VENTING

The DynaFlame® windproof cabinet protects the unit from weather, when fitted with the factory supplied air intake and UL approved vent cap (93-0298), it will be self-venting and suitable for outdoor installation.

1. Outdoor models must be installed outdoors and must use the Air Intake and Vent Cap supplied by Camus® Hydronics.
2. Periodically check to ensure that air intake and vent cap are not obstructed.
3. Locate appliance at least 3 feet away from any overhang.
4. Locate appliance at least ten feet from building air intake.

5. Avoid installation in areas where runoff from adjacent building can spill onto appliance.

For outdoor installations, always consider the use of a shelter such as a garden shed in lieu of direct exposure of the appliance to the elements. The additional protection afforded by the shelter will help to minimize nuisance problems with electrical connections and will allow easier servicing of the appliance under severe weather conditions.

### 2.4 THRUWALL VENTING

When fitted with the factory supplied vent terminal, the DynaFlame® can vent up to 100 equivalent feet. Elbows can range from 7 to 19 feet in equivalent length depending on centreline radius. Refer to table 4 for vent sizes.

Appliances may be installed with either a horizontal sidewall vent or vertical roof top vent. Terminals differ with each application. Horizontal lengths over 5 feet must be installed using corrosion resistant stainless steel. Use single wall vent and seal all joints or use pressure rated double wall vent.

When using single wall vent, all vent connector seams and joints must be sealed with pressure sensitive aluminium tape or silicone sealant as specified by the vent manufacturer. Aluminium tape must meet the provisions of SMACNA AFTS-100-73 Standard.

When venting through unheated spaces, use venting material which will minimize flue gas condensation inside the vent. Provisions must be made for collecting and disposing of any condensation which may occur. The authorities having jurisdiction must approve venting.

Periodically check to ensure that the vent terminal is unobstructed.

This venting system uses the appliance's internal combustion air fan to force the flue products out horizontally. Vent cap and venting must be listed type Category IV vent materials.

The DynaFlame® fan generates a positive pressure in the flue. Combustion air is drawn from the equipment room. The THRUWALL termination caps are available from the factory as a kit. Refer to local codes for proper installation and location of vent terminals.

#### 2.4.1 THRUWALL VENT CAP (14-0090) THRUWALL INTAKE AIR CAP (14-0101)

- The THRUWALL vent cap kit includes the wall penetration assembly and the discharge screen assembly.
- The opening through the wall for installation of the THRUWALL vent cap must provide an air space clearance of 1 inch (2.5cm) around the flue pipe. The diameter of the opening for installation of the THRUWALL vent cap will be 2 inches (5cm) larger than the nominal diameter of the installed vent pipe to the THRUWALL vent cap. The diameter of the opening for the air inlet cap will be the same as the nominal size of the pipe.
- Install the proper vent pipe to the vent cap (provided by Camus® Hydronics).
- Follow all requirements in the General Venting sections for venting flue products to the outdoors.

### 2.4.2 LOCATION OF A THRUWALL VENT TERMINATION

- The vent cap shall terminate at least 3 feet (1M) above any forced air inlet within 10 feet (3M) horizontally.
- The vent cap MUST NOT terminate below a forced air intake at any distance.
- Do not terminate the vent in a window well, stairwell, alcove, courtyard or other recessed area. The vent cannot terminate below grade.
- The vent shall not terminate less than 7 feet above a public walkway due to the normal formation of water vapour in the combustion process.
- The vent system shall terminate at least 3 foot (1M) above grade, above normal snow levels and at least 7 feet (2.15M) above grade when located adjacent to public walkways.
- The vent terminal shall not be installed closer than 3 feet (1M) from an inside corner of an L-shaped structure.
- The vent cap should have a minimum clearance of 4 feet (1.25M) horizontally from and in no case above or below, unless a 4-foot (1.25 m) horizontal distance is maintained from electric meters, gas meters, regulators and relief equipment. In all cases local codes take precedence.
- Flue gas condensate can freeze on exterior walls or on the vent cap. Frozen condensate on the vent cap can result in a blocked flue condition. Some discoloration to exterior building surfaces can be expected. Adjacent brick or masonry surfaces should be protected with a rust resistant sheet metal plate.
- The THRUWALL vent cap MUST be purchased as a kit from the factory to ensure proper operation. Locally purchased or fabricated THRUWALL vent caps should not be used.

### 2.4.3 LOCATION OF A “THRUWALL” AIR INLET CAP

- The termination point of the THRUWALL air inlet must be installed a minimum of 3 feet above ground level and above normal levels of snow accumulation.
- The point of termination for the THRUWALL combustion air inlet cap MUST be located a minimum of 3 feet (1M) horizontally and 12 inches (0.30M) below the point of flue gas termination (vent cap) if it is located within a 10 foot (3M) radius of the flue outlet.

### 2.4.4 LENGTH OF AIR INLET PIPE

The maximum total length of the THRUWALL or vertical roof top combustion air inlet pipe as installed from the appliance to the air inlet cap must not exceed (100 ft) equivalent feet (30.5m) in length. Subtract 7 (2.13 m) to 19 feet (5.8 m) of equivalent length depending on centreline radius for each 90° elbow installed in the air inlet pipe system. Pressure drop in 45° elbow will be half as much.

Do not exceed limits for the combustion air inlet piping lengths.

## PART 3 GAS CONNECTION

Verify that the appliance is supplied with the type gas specified on the rating plate. Consult factory for installations at high altitude.

### 3.1 GAS CONNECTION

- Safe operation of unit requires properly sized gas supply piping. See gas line sizing data.
- Gas pipe size may be larger than appliance connection.
- Installation of a union at the appliance gas line connection is required for ease of service and removal of the gas train.
- Install a manual main gas shutoff valve, outside of the appliance gas connection as require by local codes.
- A trap (drip leg) MUST be provided in the inlet gas connection to the appliance.
- Optional gas controls may require routing of bleeds and vents to the atmosphere, outside the building when required by local codes. required by local codes.
- Larger models of this appliance may be supplied with a gas pressure relief valve. This valve is designed to relieve lockup pressure in excess of the high gas pressure switch setting. It must be piped to discharge excess gas pressure through the valve to a safe location in accordance with local codes. Follow table 6 for sizing the vent line.

**Table 5: Gas Pressure Relief Valve – Vent Manifold Sizing Chart**

Qty. of Pressure Relief Valves being combined	Size of Combined Vent Line (Sch. 40 pipe)*	
	Pressure Relief Valve Size - 3/4" NPT	Pressure Relief Valve Size - 1" NPT
1	3/4"	1"
2	1"	1 1/4"
3	1 1/4"	1 1/2"
4	1 1/4"	2"
5	1 1/2"	2"
6	1 1/2"	2"
7	2"	2 1/2"
8	2"	2 1/2"

\*Up to 50 feet. Increase by one pipe size for every 50 feet or part thereof that the vent line extends beyond the initial 50 feet. The increase is to be made at the connection to the relief valve.

**Table 6: Recommended Gas Pipe Size**

Single Appliance Installation

(For distance from natural gas meter or propane second stage regulator)

Input Btu/ Hr x 1000	0 – 100 FT		101 – 200 FT		201 – 300 FT	
	NAT.	L.P.	NAT.	L.P.	NAT.	L.P.
500	1 1/2"	1 1/4"	2"	1 1/2"	2"	1 1/2"
750	2"	1 1/2"	2"	1 1/2"	2 1/2"	2"
1,100	2"	1 1/2"	2"	1 1/2"	2 1/2"	2"
1,200	2"	1 1/2"	2 1/2"	2"	2 1/2"	2"
1,500	2 1/2"	2"	2 1/2"	2"	3"	2 1/2"
1,750	2 1/2"	2"	3"	2 1/2"	3"	2 1/2"
2,000	2 1/2"	2"	3"	2 1/2"	3"	2 1/2"
2,500	3"	2 1/2"	3"	2 1/2"	3 1/2"	3"
3,000	3"	2 1/2"	3"	2 1/2"	3 1/2"	3"
3,500	3"	2 1/2"	3 1/2"	3"	4"	3 1/2"
4,000	3 1/2"	3"	4"	3 1/2"	4"	3 1/2"
4,500	3 1/2"	3"	4"	3 1/2"	4"	3 1/2"
5,000	4"	3 1/2"	4"	3 1/2"	5"	4"
6,000	4"	3 1/2"	4"	3 1/2"	5"	4"

### 3.2 GAS PIPING

All gas connections must be made with pipe joint compound resistant to the action of liquefied petroleum and natural gas. All piping must comply with local codes and ordinances.

### 3.3 INSTALL PIPING

- The gas line should be sufficient to handle the total installed capacity. Verify pipe size with gas supplier.
- Use new, properly threaded black iron pipe free from burrs. Avoid flexible gas connections. Internal diameter of flexible gas lines may not provide appliance with proper volume of gas.
- Install a manual main gas shutoff valve at the appliance gas inlet, outside of the appliance and before the gas valve. Install a joint union at the appliance gas line connection for ease of service and removal of the gas train.
- Run pipe to the Appliance gas inlet.
- Install a sediment trap in the supply line to the Appliance gas inlet.
- Apply a moderate amount of good quality pipe compound.
- For LP gas, consult your LP gas supplier for expert installation.

The appliance and its individual gas shut-off valve must be disconnected from the supply piping when pressure testing the gas supply piping at pressures above 1/2 PSI

**Table 7: Gas Pressures at Inlet to Appliance**

	PROPANE	NATURAL GAS
Minimum (inches W.C.)	11	4.5*
Maximum (inches W.C.)	11	14

\* 3" for 500 and 750 models. 3.5" for 1100 and 1200 models. 4.5" for models 1500 – 6000. Recommended regulator settings is 7.0" w.c

The gas supply line must be of adequate size to prevent undue pressure drop and must never be smaller than the size of the connection on the appliance. Sizing based on Table 7 is recommended.

Before operating the appliance, the complete gas train and all connections must be tested using soap solution.

Verify that the appliance is supplied with the type gas specified on the rating plate. Heating values of local natural gas are to be between 950 and 1010 Btu/ft<sup>3</sup>. Consult factory if heating values are outside this range or if a gas with a mixture of constituents is being used.

### 3.4 AIR/GAS RATIO VALVE

The main gas valves supplying gas to the burner for models 2000 to 5000 on this appliance utilize a servo pressure regulator providing a slow opening, fast closing safety shut off and an air/gas ratio control valve for the gas combustion process. This gas valve controls the pressure difference across the flow orifice in the manifold supply line as a function of the pressure difference across the combustion air supply to the burner. The actuator maintains a constant air to gas ratio as the volume of air changes based on the operation of the combustion air fan. The valve is a 1:1 differential pressure air/gas ratio controller. The valve generates the same pressure difference on the gas side as it senses on the air side. Models 500 to 1750 utilize a 1:1 ratio dual seat negative pressure gas valve. Models 2000 – 3000 utilize a 1:1 air/gas ratio control valve and a safety solenoid valve. Models 3500 – 6000 utilize a 1:1 air/gas ratio control and regulating gas valve. The regulating gas valve performs the functions of a pressure regulator, safety shutoff. Full closing of the valve seat occurs in less than 0.8 seconds when the valve is de-energized. Operation of the gas valve in combination with the combustion air fan allows the burner input rate to vary from 20% to 100% based on temperature demand. The inlet gas supply pressure must be maintained within the specified minimum and maximum pressures.

The air/gas ratio is preset at the factory and adjustment is not usually required if gas supply pressure is maintained within the specified range.

There are no serviceable parts on the dual seat negative pressure air/gas ratio valve control.

A reduction of up to 30% is permitted in the inlet gas pressure between light off and full fire conditions.

If the manifold differential pressure is to be measured, refer to section 3.8 Checking Differential Air and Gas Pressures for proper measurement.

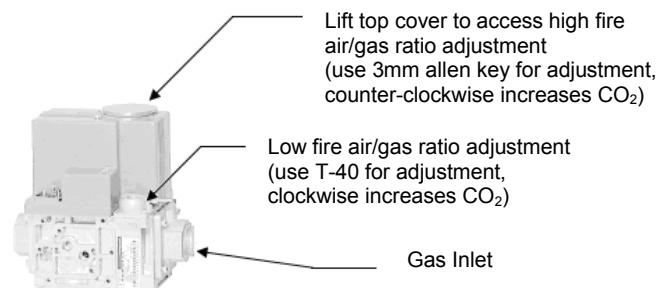
**Figure 8: DF500 – 1750 1:1 Negative Pressure Air Gas Ratio Control Valve**

**Figure 9: DF2000-60041:1 Air/Gas Ratio Control Valve**

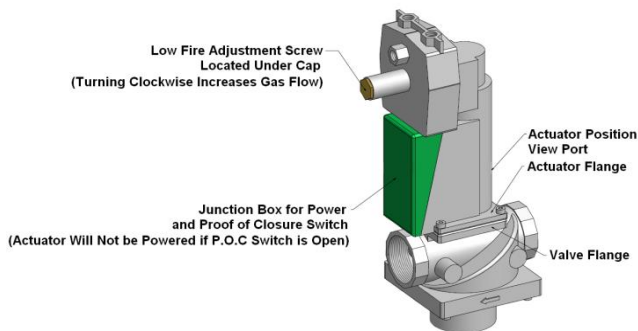

**Figure 10: DR3500 – 5000 SKP25 Regulating Gas Valve Actuator &SSOV**



### 3.5 DIFFERENTIAL AIR PRESSURE (DF2000 -6004)

- The DynaFlame® operates on the principle of differential pressures. Operation of the fan generates a signal which is matched on the gas side by the 1 to 1 air/gas ratio control valve.
- The differential air pressure measurement is made between the high and low pressure taps across the fan discharge and the flue vent. All differential air pressures are noted at full firing rate. There are two pressure taps at the fan discharge and care must be taken to tee into the correct line. The correct line may be identified by tracing it back to the ratio control valve where the identification of the tapping is stamped into the die cast actuator.
- The differential gas pressure measurement is made between the high and low pressure taps across the in-line metering gas orifice. Check this value to confirm that it matches the differential air pressure while the appliance is firing.
- The controls on this appliance may fire the burner from 35% up to 100% for non-condensing and from 20% up to 100 % for near-condensing and condensing of rated input.
- Differential manifold gas pressure will be reduced as burner input is reduced.
- All reference gas pressure measurements must be made at 100% of rated burner input.
- The differential gas manifold pressure is pre-set at the factory through the ratio gas valve. Adjustment of manifold pressure is not normally required for proper operation. In the field it may be necessary to adjust the low fire adjustment screw located on the ratio control valve actuator in order to achieve acceptable light off under soft start field conditions.
- **Always check settings posted on boiler test label.**

### 3.6 GAS MANIFOLD DIFFERENTIAL PRESSURE ADJUSTMENT (DF2000 – DF6004)

Tampering with gas valve adjustments after startup and commissioning will void the warranty on the gas valve assembly and the burner.

The appliance's manifold gas pressure **IS NOT** field adjustable after startup and commissioning. The gas valve pressure ratios have been factory set with an internal bias adjustment to ensure a 1:1 air/gas ratio on operation. Tampering with this adjustment by a non-factory trained technician will void the warranty on the gas valve assembly and the burner. An appliance supplied with a properly sized gas line, properly sized meter and a minimum gas supply pressure (See Table 8 for minimum allowable inlet gas supply pressure) while firing at full rate will ensure full burner input. The manifold pressure supplied to the burner is a differential pressure. This pressure is the result of the difference in two gas pressure measurements. A differential manifold gas pressure measurement should not be made until you have measured the gas supply pressure. Gas supply pressure must be at least at minimum allowed with all appliances on the gas line firing at full rate before a manifold pressure measurement is made. Use the following procedure to check gas supply pressure with a manometer connected to the inlet pressure tap on the gas line connection at the rear of the appliance.

### 3.7 CHECKING GAS SUPPLY PRESSURE

- Turn the main power switch to “OFF” position.
- Shut off gas supply at the manual gas cock in the gas piping to the appliance. If fuel supply is LP gas, shut off gas supply at the tank.
- **Models 500 – 3000:** Remove the 1/8" hex plug from the gas pressure test port located on the inlet gas supply connection at the rear of the appliance. Install a fitting in the inlet pressure tapping suitable to connect to a manometer or magnahelic gauge. Range of scale should be 0 to 14 inch W.C. or greater to check inlet pressure
- **Models 3500 – 5000:** Remove the 1/8" hex plug downstream of the SKP25. Install a fitting in the inlet pressure tapping suitable to connect to a manometer or magnahelic gauge. Range of scale should be 0 to 14 inch W.C. or greater to check inlet pressure
- Turn on gas supply at the field installed manual gas cock; turn on LP gas at tank if required.
- Turn the power switch to “ON” position.
- Adjust the thermostat set point to call for heat.
- Observe the gas supply pressure as the burner fires at 100% of rated input.
- Ensure inlet pressure is within specified range. Minimum and maximum gas supply pressures are specified in Gas Supply section of this manual.
- If gas pressure is out of range, contact the gas utility, gas supplier, qualified installer or service agency to determine necessary steps to provide proper gas pressure to the control.
- If gas supply pressure is within normal range, proceed to remove gas manometer and replace pressure tap fittings in the gas piping to the appliance.
- Turn on gas supply at the manual valve; turn on LP gas at tank if required.

- Turn the power switch to “ON” position.
- Adjust the thermostat temperature set point to the desired water temperature so the appliance will call for heat.
- Check appliance performance by cycling the system while you observe burner response. The burner should ignite promptly. Flame pattern should be stable, see “Maintenance-Normal Flame Pattern.” Turn system off and allow burner to cool, then cycle burner again to ensure proper ignition and flame characteristics.

**IMPORTANT**

Upon completion of any testing on the gas system, leak test all gas connections with a soap solution while the main burner is firing. Immediately repair any leak found in the gas train or related components. DO NOT operate an appliance with a leak in the gas train, valves or related gas piping.

**3.7.1 Regulated Gas Supply Pressures for DynaFlame® Boilers & Water Heaters**

A stable gas supply pressure is extremely important to avoid rough starts with machines like the DynaFlame® which use a 1 to 1 ratio control valve for internal gas pressure regulation.

Camus® requires that all DynaFlame® models equipped with the SKP25 be supplied with no more than 1 PSI incoming supply pressure. This means that lockup pressure must not exceed 1 PSI. For models **NOT** incorporating the SKP25 lockup pressure must not be in excess of 14” w.c.

It is paramount that maximum lockup pressure be confirmed before any attempt is made to start up the appliance.

A suitable lockup regulator with internal or external relief will not exceed running pressure by more than 20%, which means that the regulator must be capable of rated gas flow with a maximum running supply pressure of 7.5” W.C.

When required the boiler should be installed with a final stage gas regulator that is to be located as close as possible but no more than 10 feet from the appliance.

It is paramount that maximum lockup pressure be confirmed before any attempt is made to start up the appliance.

Operating the DynaFlame® at lockup pressures exceeding the recommended levels can lead to delayed ignitions and damage to the appliance.

**3.8 CHECKING DIFFERENTIAL AIR AND GAS PRESSURES (DF2000 - DF6000)**

**Figure 11 – Differential Air Pressure Manometer Connection**

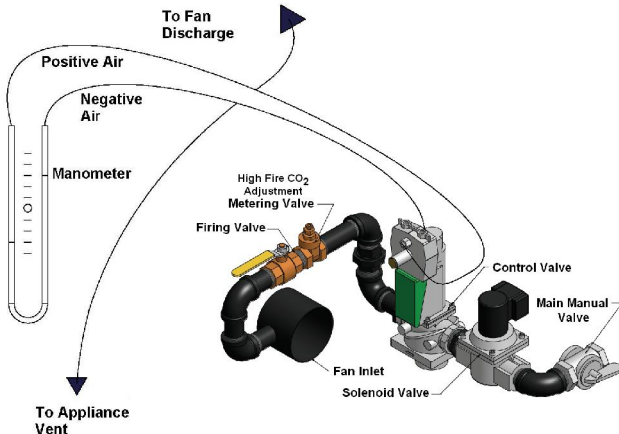

- The 1 to 1 air/gas ratio control actuator has embossed markings identifying + air – air, + gas & - gas connections. Using a test hose assembly fitted with tees, connections can be made from the manometer to the appropriate ports on the actuator.
- Using tees connect a hose from the positive air and the negative air to each of the two sides of a manometer. This will allow the two pressure points to be measured while at the same time the actuator still receives the proper operating signal.
- If a second manometer is available it can be connected to the appropriate gas ports. Typically the gas signal will closely follow the air signal on all models. If the incoming gas pressure reduces significantly as the Variable Frequency Drive (VFD) accelerates to maximum speed the gas signal may lag behind the air signal by up to 15%. This will occur once the actuator has driven downwards as far as it can go. The amount that the actuator has opened is registered by an indicator arm which is visible through the view window.
- As the appliance comes on and fires, record the maximum inches of water column which is achieved at maximum speed on the VFD using start-up report form (93-0130). To adjust this differential pressure when commissioning the appliance, use the adjusting screw on the air shutter to the fan. Readings are to correspond to the values shown on the test sticker. In all cases the final adjustment is to be made using a combustion analyzer. Depending on field conditions differential pressures will have to be adjusted accordingly. Typically with long lateral runs the differential signal as read will be reduced from the value shown on the test sticker. The opposite will occur with tall stacks where drafts exceed negative 0.15”W.C.
- If the appliance will not light off and the blue ‘main flame’ light is coming on but not staying on then it will be necessary to adjust the low fire as explained in the detailed start-up procedure.

**3.9 GAS TRAIN AND CONTROLS**

**Figure 12: Typical Gas Train (DF2000 – 3000)**

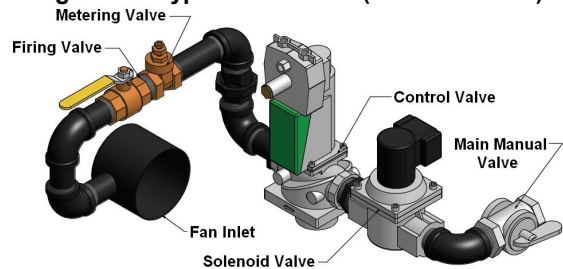

**Figure 13: Typical Gas Train (DF 3500 – 6004)**

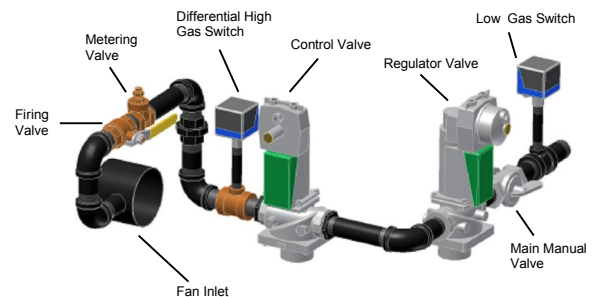

### 3.10 VENTING OF GAS VALVES AND PRESSURE SWITCHES

The optional gas pressure switches may be provided with threaded termination points to be vented to the atmosphere, outside the building. The gas pressure regulation function is provided by the ratio gas valve which does not require installation of a vent line. The optional gas pressure switches are installed in the upper chamber of the appliance. Threaded vent line connections from components requiring an external vent line are provided on the component. These vent line connection points may be accessed by removing the top of the appliance. Local codes may require the routing of these bleeds and vents to the atmosphere, outside the building. Proper routing of vent lines to the atmosphere from the factory supplied termination points is the responsibility of the installing contractor.

### 3.11 BURNER

Figure 14: Burner

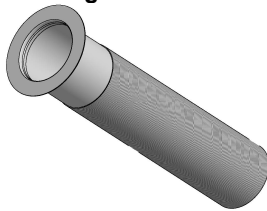

This appliance uses a single cylindrical burner installed vertically into the cavity located in the center of the primary heat exchanger. There is a unique burner for each one of the sixteen models.

Burners may NOT be interchanged between different Btu/hr input models. The burner consists of a round mounting flange welded to a mixing tube. The top side of the mixing tube provides the transition which mounts the discharge from the combustion air fan into the burner. The bottom side of the mixing tube is attached to a stainless steel perforated sleeve. This stainless steel sleeve is covered with a knitted alloy material that forms the burner port surface. The knitted burner port material is called metal fiber which is a unique alloy of iron, chrome, aluminum and several rare earth metals. This alloy is designed to operate stress free as a burner port surface. The burner port surface can sustain operation from a blue flame down to infrared conditions as the burner input varies. In order to maximize the operating life of the burner, the normal operating mode for the DynaFlame® is a blue flame. Infrared operation will occur only if air to gas adjustments is incorrect. If infrared operation is noted the cause must be corrected.

**Model 500 – 2500:** Direct ignition is standard. The burner mounting flange provides a flame view port and the mounting point for the hot surface igniter and the flame sensor.

**Model 3000 – 6000:** Proven pilot ignition is standard. The burner mounting flange provides a flame view port, the mounting point for the hot surface igniter, a connection to the pilot tube and the flame sensor.

The hot surface igniter and flame sensor are removable from the burner mounting flange without removing the burner assembly from the heat exchanger.

**Never use an open flame (match, lighter, etc.) to check gas connections.**

## PART 4 WATER CONNECTION

- Check all applicable local heating, plumbing and building safety codes before proceeding.
- If the appliance is installed above radiation level it must be provided with a low water cut-off device at the time of appliance installation (available from factory). Some local codes require the installation of a low water cut-off on all systems.
- A pressure relief valve is supplied with each DynaFlame®. The relief valve must be mounted in a vertical position and piped to the floor in a manner acceptable to the enforcing authority.
- Minimum operating system pressure should not drop below 30 PSIG.
- Be sure to provide unions and gate valves at inlet and outlet to the appliance so that it can be easily isolated for service. The provision of a flow setter valve at the appliance outlet will facilitate setting of the proper flow at the desired temperature rise at high fire. It is particularly important to confirm proper temperature rise for domestic hot water applications. Improper flows can lead to premature tube failure from erosion or scaling and will not be covered by warranty.
- This appliance is a low mass design which provides for instant heat transfer. Special attention to water flow rates will ensure that temperature rise is not excessive. See Table 9.
- To eliminate trapped air, install venting devices at high points in the system as well as in the piping on the suction of the pump and in the piping on the discharge of the appliance.
- Use suitable pipe hangers or floor stands to support the weight of all water and gas piping.
- Always pump toward the heat exchanger inlet. Never pump away from the exchanger since this will result in a low-pressure zone, which will allow localized boiling and result in heat exchanger damage.
- Do not allow the appliance to run with inlet water temperature below 115°F (46°C) for non-condensing and 130°F (55°C) for near-condensing and condensing appliances.
- DynaFlame® must be installed so that the gas ignition system components are protected from water (dripping, spraying, rain, etc.) during appliance operation and service (circulator replacement, control replacement, etc.)

Figure 15: Typical Space Heating System

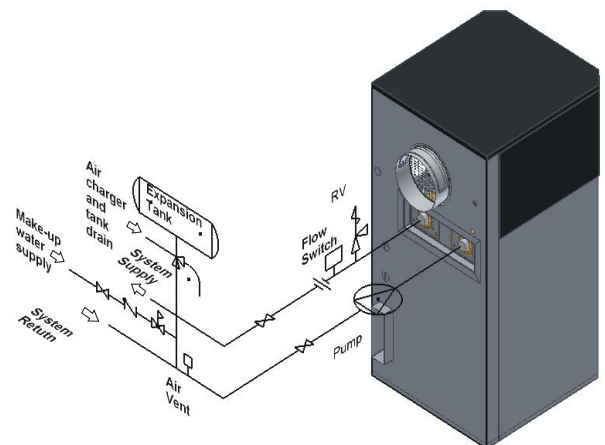

#### 4.1 FREEZE PROTECTION

- Appliance installations are not recommended outdoors in areas where danger of freezing exists unless precautions are taken. Maintaining a mixture of 50% water and 50% propylene glycol is the preferred method of freeze protection in hydronic systems. This mixture will protect the appliance to approximately -35°F (-37°C). To maintain the same temperature rise across the appliance increase the GPM flow by 15% and the head loss by 20%.

The following example demonstrates the procedure to follow for calculating the revised head for the heat exchanger when using a water / glycol mixture.

- Given that Camus® is showing a heat exchanger flow and head loss of 100 gpm @ 10 feet
- Increasing the flow by 15% now results in a head loss of 13 feet at 115 gpm (from B&G system syzer). At this increased flow Camus® now recommends to increase the head loss by 20%.
- The requirement for the heat exchanger with water / glycol mixture will now be 115 gpm @ 15.6 feet. (ie.  $1.2 \times 13\text{ft.} = 15.6\text{ft.}$ )
- A similar procedure must be followed to calculate the additional head loss in pipe and fittings in order to arrive at the proper pump selection.
- For Outdoor installations in colder climates a snow screen should be installed to prevent snow and ice accumulation on and around the appliance. Regular inspections should be made to ensure that air intake and vent are free of snow and ice. Always consider the use of a shelter such as a garden shed in lieu of direct exposure of the appliance to the elements. The additional protection afforded by the shelter will help to minimize nuisance problems with electrical connections and will allow easier servicing of the appliance under severe weather conditions.

#### 4.2 WARNING REGARDING CHILLED WATER & HEATING COIL SYSTEMS

When an appliance is connected to an air conditioning system where the same water is used for heating and cooling, the chiller must be piped in parallel with the appliance. Appropriate flow control valves; manual or motorized must be provided to prevent the chilled water from entering the appliance.

The appliance piping system of a hot water boiler connected to heating coils located in air handling units where they may be exposed to refrigerated air circulation must be equipped with flow control valves or other automatic means to prevent gravity circulation of the boiler water during the cooling cycle.

Figure 16: Chilled Water System

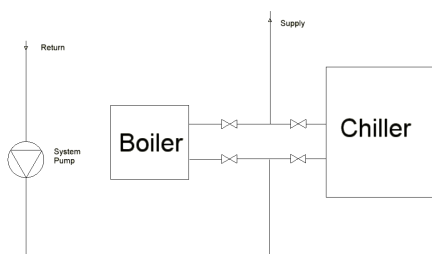

#### 4.3 INLET AND OUTLET CONNECTIONS

- All water connections meet American National Standard Pipe Threads (NPT).
- For ease of service, install unions on inlet and outlet of the appliance. The connection to the appliance marked "Inlet" on the header should be used for return from the system. The connection on the header marked "Outlet" is to be connected to the supply side of the system.

#### 4.4 MINIMUM PIPE SIZE REQUIREMENTS

Minimum water pipe connections are as follow for DynaFlame® for single unit installations. The equivalent number of straight feet of pipe for each valve and fitting in the connecting piping must be considered to properly arrive at the total equivalent feet of straight pipe in the field installed piping to the appliance. See the piping requirements in Part 12 - Installation section of this manual. Consult factory if longer piping distances are required for a specific application.

#### 4.5 PRIMARY HEAT EXCHANGER

This appliance uses copper or stainless finned tubing to maximize the heat transfer process. The copper heat exchanger is comprised of vertical tubes rolled directly into two circular bronze headers. The stainless heat exchanger is an all welded construction. It is comprised of two rows of vertical tubes welded into two circular stainless steel headers. Both heat exchangers are designed to withstand 160 PSIG working pressure. A series of "V" shaped baffles are installed between the individual tubes to control the movement of the flue products over the finned tubes to maximize efficiencies.

A factory recommended circulating pump ensures proper water flow during burner operation and creates enough water turbulence inside the finned tubes and header that prevents the formation of sediments. Temperature rise and erosion prevention in the primary heat exchanger are controlled by the selection of a properly sized circulating pump. To ensure proper operation and ensure longevity of this heat exchanger minimum inlet water temperatures of 115°F (46°C) MUST BE maintained for non-condensing models and 130 °F (55°C) for near-condensing and condensing models.

When return water temperatures are below the recommended temperature, the flue products passing over the copper finned tubes will be cooled below their dew point resulting in the formation of corrosive condensation on the copper which shorten its life. Under these conditions condensation will collect in the base of the inner combustion chamber. Follow the piping recommendations given for low water temperature systems if water temperatures are expected to be below the recommended value. During initial operation of the appliance in a cold system some condensation will be generated but it will be quickly evaporated once the system return temperature reaches 115°F (46°C).

## Return Water Temperatures Required for DynaFlame® Boilers & Water Heaters

Minimum acceptable return water temperatures are determined by the category of the heater. This is true for all manufacturers.

A category I machine like the non-condensing version of the DynaFlame® 85% efficient model can be operated with return water temperatures as low as 115°F (46°C) provided that the control algorithm is correct. Proper operation requires initial startup of the machine followed by ramp up to high fire. This sequence minimizes initial condensation and generates stack temperatures which dry up initial condensation in the vent.

Category II machines like the near condensing version DynaFlame® 88% efficient model (DFX) and the condensing DynaFlame® 95% efficient can be operated down to 20% firing rate from initial startup. These machines must be operated with a return water temp of at least 130°F (55°C) to the primary heat exchanger in order to avoid condensation there. For these appliances condensation in the vent is not an issue because they are installed with a special venting system designed to withstand the corrosive action of condensate.

The Camus® designs are versatile and user friendly, they deliver optimal performance by taking full advantage of existing site conditions in order to maximize energy savings.

### IMPORTANT

Operating this appliance at return water temperatures below the recommended temperature (except initial heat up) may cause primary heat exchanger to fail and may eventually cause hazardous conditions that may result in personal injury or non-warrantable damage to the unit.

## 4.6 LOW WATER TEMPERATURE SYSTEMS

All DynaFlame® heaters can be configured for low water temperature applications including open water reservoir heating.

Recirculation loops required for these applications can be set up in the field or they can be supplied pre-piped from the factory.

In applications where the heating system requires supply water temperatures below the recommended temperature, a bypass line must be installed upstream of the appliance pump so that outlet water can be re-circulated to raise the inlet temp to a minimum of the recommended temperature. Balancing valves, preferably circuit setter or globe valves are used to adjust flow. (See Figure 16)

Figure 17: Typical Low-Water Temperature System (Non-Condensing)

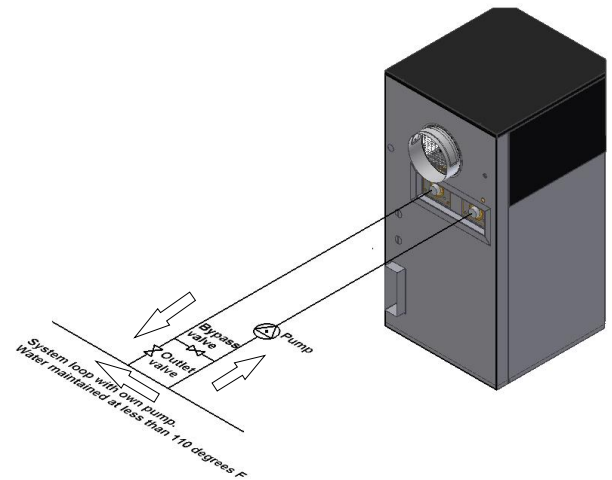

### Adjustment Procedure

- Fully open bypass and outlet valves.
- With appliance running, read appliance inlet temperature after 15 minutes.
- If inlet temperature is less than the recommended temperature slowly close outlet valve until the inlet temperature climbs to slightly above the recommended temperature.
- If inlet temperature is greater than the recommended temperature but not greater than 140°F no further adjustment is required.
- Check inlet temperature after 5 minutes and make final adjustments.
- Remove handle of balancing valve to prevent tempering.

Note: For applications where large volumes of water are heated from ground water temperatures to process temperatures, it will be necessary to provide a modulating three way valve or thermostatic valve in lieu of a fixed bypass line.

## 4.7 INSTANTANEOUS WATER HEATER (non-condensing)

An instantaneous water heater is designed to deliver hot water without the use of a storage tank. It is suitable for applications with variable load such as restaurants, condominiums, apartments and motels and typically used in conjunction with tempering valves to achieve temperature control. In some applications it may be appropriate to provide a flow through tank to act as a buffer. Consult factory for recommendations. (See Figure 17)



**Figure 18: Typical Instantaneous Water Heating System**

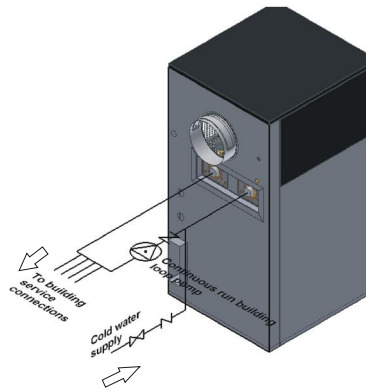

**Table 8: Flow and Pressure Drop at a Given Temperature Rise (Copper, Copper Nickel Heat Exchanger)**

Model	Heat Exchanger Water Content (USG)	30°F (16.7 °C) Temp Rise		35°F (19.4°C) Temp Rise	
		USGPM (min. flow)	ΔP Ft.	USGPM (min. flow)	ΔP Ft.
DF500	2.5	28.0	0.7	24.0	0.5
DF750	2.9	42.0	1.4	36.0	1.0
DF1100	3.5	61.6	2.7	52.8	2.1
DF1200	3.5	68.0	2.9	58.3	2.2
DF1500	6.3	83.9	1.9	71.9	1.4
DF1750	6.6	97.9	2.9	83.9	2.2
DF2000	7.0	111.9	4.1	95.9	3.1
DF2500	7.5	139.9	6.1	119.9	4.6
DF3000	8.0	167.9	8.4	143.9	7.0
DF3500	8.4	198.1	12.7	169.8	9.5
DF4000	8.9	226.9	17.0	194.5	12.7
DF4500	9.3	254.7	21.9	218.3	16.4
DF5000	9.7	282.9	27.6	242.5	20.7
DF4504	9.3	254.6	15.3	218.3	11.4
DF5004	9.7	283.0	19.6	242.5	14.9
DF6004	10.2	339.5	31.8	291.0	24.1

**Table 9: Flow and Pressure Drop at a Given Temperature Rise (Stainless Steel Heat Exchanger)**

Model	Heat Exchanger Water Content (USG)	20°F (11.1 °C) Temp Rise		25°F (14°C) Temp Rise	
		USGPM (min. flow)	ΔP Ft.	USGPM (min. flow)	ΔP Ft.
DF500	2.5	42.0	1.5	33.6	1.0
DF750	2.9	63.0	3.0	50.4	1.9
DF1100	3.5	92.4	5.9	73.9	4.0
DF1200	3.5	102.0	4.4	81.6	2.8
DF1500	5.6	125.9	8.3	100.7	6.0
DF1750	5.9	135.0	12.5	117.5	8.0
DF2000	6.2	167.9	6.7	134.3	4.5
DF2500	6.6	209.9	8.4	167.9	5.4
DF3000	7.1	251.9	9.9	201.5	6.3
DF3500	7.5	297.2	11.8	237.8	7.4
DF4000	7.9	340.4	17.1	272.3	11.0
DF4500	9.3	382.1	28.4	305.7	17.5
DF5000	9.7	424.4	31.1	339.5	20.0
DF4504	9.6	382.1	20.4	305.7	13.3
DF5004	10.1	424.4	23.5	339.5	15.4
DF6004	11.1	509.3	38.0	407.4	24.5

#### 4.8 CONDENSER HEAT RECOVERY MODULE (CHRM)

The DynaFlame® ALL Stainless Steel CHRM is mounted in a stainless steel inner jacket chamber at the right side of the appliance facing the appliance. The CHRM is constructed from all stainless steel headers and special multiple horizontal stainless tubes. This CHRM is designed to maximize heat transfer efficiency by fully condensing flue products and is suitable to resist the low PH of condensate.

The CHRM must be supplied with adequate water flow at all times during operation. Do not operate the appliance with the CHRM piped out or isolated.

The CHRM is mounted in the discharge of the flue products from the primary heat exchanger. This allows additional heat to be absorbed from the flue products exhausted from the combustion process. If isolation valves are provided on the CHRM, the provision of a relief valve at the outlet of the CHRM is recommended. This valve is to be sized at minimum for 10% of the input of the appliance and is to be piped to drain.

When cold water supply with temperatures less than 130 °F (54 °C) passes through the CHRM it will cool the flue products below dew points resulting in the formation of condensation. Furthermore, the volumetric flow rate of the flue gases will be reduced. Never supply water at less than 35°F to the CHRM.

The appliance CHRM loop may be used in condensing mode for a variety of application including domestic hot water and hydronic space heating. Recommended piping arrangement is shown in Figure 18 Maximum recommended flows through the CHRM is summarized in Table 10.

**Figure 19: Typical Condensing System**

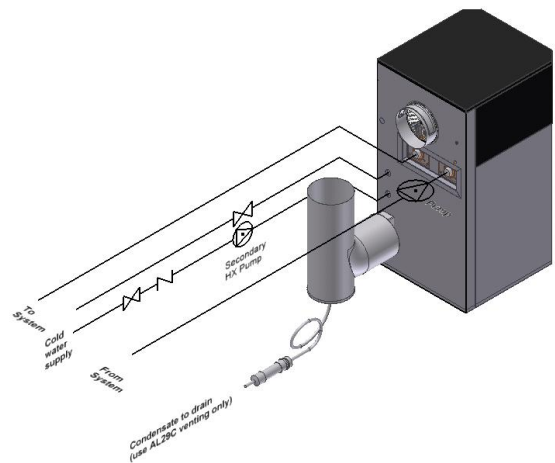

Condensate from the DynaFlame® must be treated before being discharged to drain. PH level of the condensate is to be checked regularly and the neutralizing medium is to be replaced as required. A neutralizing cartridge is available from the factory. The condensing DynaFlame® must be vented using only special venting type AL29-4C stainless steel or equivalent, please follow instructions detailed below.

When supplied with the CHRM, the DynaFlame® is 95% efficient (category II or IV appliance) which requires the use of a special venting system fabricated from AL29-4C or equivalent material. Only venting components listed by a nationally recognized testing agency may be used.

This appliance may be installed with conventional, sidewall or vertical venting. Conventional vented appliances operate with negative pressure in the vent pipe and require a special vent adapter to increase the flue outlet diameter. Sidewall and vertically vented appliances operate with positive pressure in the vent pipe and may be directly connected to the flue outlet without the use of an increaser. Consult the vent pipe manufacturer's instructions for minimum clearances to combustible material for vent components. In the absence of instructions, the minimum clearance to combustible material is six inches.

Consult vent pipe manufacturer's instructions for proper method of sealing vent pipe sections and fittings. In the absence of instructions, make sure that pipe and fittings are clean by swabbing with alcohol. Use Dow Corning 736 or 732 RTV, Polybar # 500 RTV or Sil-bond 4500 or 6500 to seal vent pipe. Do not use other sealants or adhesives except as expressly permitted by vent manufacturer's instructions.

Consult vent pipe manufacturer's instructions for vent system assembly. Follow vent pipe manufacturer's instructions if those instructions differ from this section.

**Conventional Venting**

Multiple appliances may be vented into a conventional chimney. The chimney must be lined with AL29-4C or equivalent and a barometric damper is to be provided as required for each appliance to control the draft.

A qualified professional using a proven vent-sizing program with input of accurate operating parameters must properly calculate sizing of the venting system. In applications where flue gas temperatures are lower than can support a Category II with conventional negative draft, it will be determined at the venting design stage that a positive pressure will be developed in the vent. It will then be necessary to either provide separate vents as for Category IV, to pressurize the boiler room, or to provide an extractor at the chimney outlet in order to maintain a negative draft in the chimney and allow common venting.

The chimney must be protected from down drafts, rain and debris by using a listed chimney cap. Approval of the installation will be at the discretion of authorities having jurisdiction.

**Sidewall and Vertical Venting**

The maximum vent length is 100 equivalent feet. Vent pipe may be run through a vertical or horizontal chase provided that minimum clearances to combustible materials are maintained. The vent should terminate a minimum 12 inches above grade plus normally expected snow accumulation, or 7 feet above grade if located adjacent to public walkways. Do not install over public walkway where local experience indicates condensation or vapour from the boiler creates a nuisance or hazard. Minimum 3 feet above any forced air inlet located within 10 feet of vent termination. Minimum 4 feet below, 4 feet horizontally or above any door window or gravity air inlet. Minimum 4 feet horizontally from electric meters, gas meters, regulators and relief valves. Use appropriately designed thimbles when passing through combustible walls or roofs. Install fire stops where vent passes through floors, ceilings or framed walls. The fire stop must close the opening between the vent pipe and the structure. Locate vent terminal above

combustion air intake terminal (if used) and no closer than 2 feet vertically or horizontally. Vertical venting requires flashing and a storm collar to prevent moisture from entering the structure. Vertical vent termination must be at least 2 feet plus the expected snow accumulation above the roof penetration height.

**4.9 CHRM, FLOW and PRESSURE DROP**

**Figure 20: Secondary Heat Exchanger**

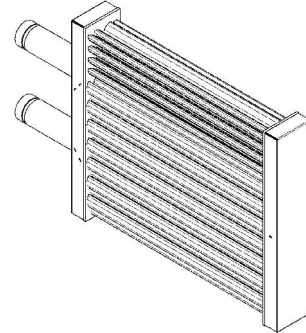

**Table 10: CHRM Head Loss & Flow for 10°F Rise**

Model	US GPM	ΔP - Ft.
500	10.0	0.4
750	13.0	0.7
1100	22.0	1.8
1200	24.0	2.1
1500	30.0	3.1
1750	35.0	4.2
2000	40.0	5.5
2500	50.0	8.0
3000	60.0	11.5
3500	*40.0	8.5
4000	*46.0	11.0
4500	*52.0	14.0
5000	*57.0	16.5
4504	*52.0	14.0
5004	*57.0	16.5
6004	*68.0	25.0

\*Flow for 15°F rise at high fire

**4.10 WATER FLOW SWITCH (shipped loose)**

A water flow switch is shipped loose on copper and copper nickel heat exchangers and is to be installed in the outlet piping on all heating boilers and hot water supply boilers equipped with the copper heat exchanger. Stainless steel heat exchanger DynaFlame's are equipped with a flow switch that is mounted and installed in the outlet boiler/ hot water heater connection. The flow switch is mounted and installed on the outlet piping of a stainless steel heat exchanger DynaFlame®. The flow switch is wired in series with the 24VAC safety control circuit. A diagnostic light will be indicated on the control display on a low flow condition.

#### 4.11 LOW WATER CUTOFF (If Equipped)

If this boiler is installed above radiation level, a low water cut-off device must be installed at the time of boiler installation. Some local codes require the installation of a low water cut-off on all systems. Electronic low water cut-offs are available as a factory supplied option on all models. Low water cut-offs should be tested every six months. The normally open switch contact of the low water cutoff is to be wired in series with the flow switch. A diagnostic light will be indicated on the control display on a low flow condition.

**Caution:** remove jumper when connecting to 24 VAC circuit.

**Figure 21: Low Water Cut Off Electrical Connections (Watts)**

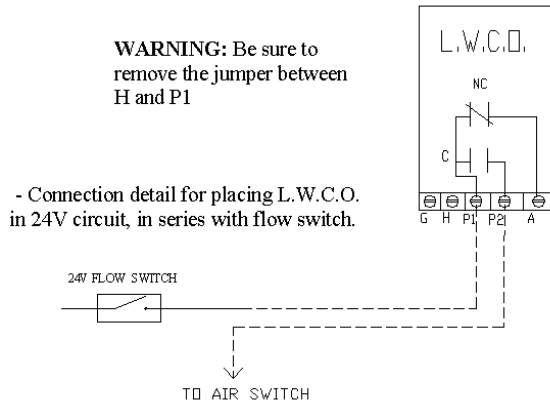

**Figure 22: Low Water Cut Off Electrical Connections (ITT)**

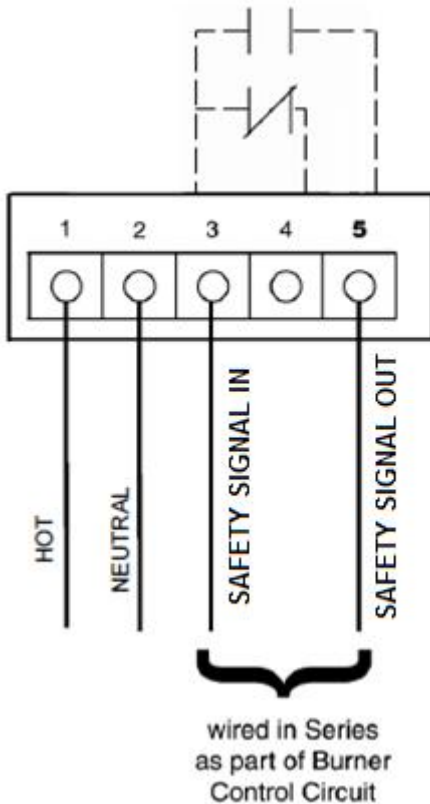

#### 4.12 RELIEF VALVE (shipped loose)

This appliance is supplied with a relief valve sized in accordance with ASME Boiler and Pressure Vessel Code, Section IV ("Heating Boilers"). The relief valve is to be installed in the vertical position and mounted in the hot water outlet. No valve is to be placed between the relief valve, and the appliance. To prevent water damage, the discharge from the relief valve shall be piped to a suitable floor drain for disposal when relief occurs. No reducing couplings or other restrictions shall be installed in the discharge line. The discharge line shall allow complete drainage of the valve and line. Relief valves should be manually operated at least once a year.

**CAUTION**  
Avoid contact with hot discharge water

#### 4.13 CONDENSING HEAT RECOVERY MODULE PIPING CONFIGURATIONS

**Caution:** If isolation valves are provided on the CHRM, the provision of a relief valve at the outlet of the secondary is recommended. This valve is to be sized at minimum for 10% of the input of the appliance and is to be piped to drain in a manner similar to the appliance relief valve.

##### 4.13.1 CHRM IN SERIES WITH PRIMARY HEAT EXCHANGER (INTEGRATED LOOP)

The supply water (Cold water) is pre-heated by CHRM and fed into the outlet of the primary Heat Exchanger. Provisions must be made to prevent cold water below 115°F (46°C) entering to the Primary Heat Exchanger.

##### BOILER APPLICATION (HYDRONIC HEATING)

In case of boilers (Hydronic heating boiler) application, the return water (supply water) may be more than 115°F (46°C), therefore there is no need for a recirculation loop and the primary heat exchanger and CHRM can be piped in parallel. Since the inlet water temperature to CHRM exceeds 110°F (44°C) it will not condense fully and therefore the CHRM will not perform to its maximum efficiency capacity. If water colder than 110°F (44°C) is available it can be fed to the CHRM.

##### WATER HEATER APPLICATION (HOT WATER SUPPLY)

In case of domestic water supply (Water Heating), the fresh inlet water temperature will be less than 110°F (44°C), in this case the CHRM may be fed directly with part of the supply water using a secondary pump.

#### 4.14 CIRCULATING PUMP SELECTION

The appliance has a low mass finned tube heat exchanger for fast response and high heat absorption. Selecting the proper pump will ensure that temperature rise does not exceed recommended maximum  $\Delta T$  and that heat exchanger tubes are not prematurely scaled or eroded.

##### 4.14.1 CIRCULATING PUMP OPERATION PRIMARY HEAT EXCHANGER

**MOST IMPORTANT**

This appliance is designed for continuous pump operation when the burner is firing. The circulating pump will run continuously when the power switch is in the "ON" position. As an optional feature a pump control system can be provided. The pump control option allows the appliance circulating pump to be cycled "ON" prior to the burner firing and cycled "OFF" some time after the set point is satisfied.

The operation of the circulating pump is controlled by the SOLA temperature control. When the appliance is activated by a remote operating signal the pump will start and run for the operating cycle and for a post purge period based on temperature difference between inlet and outlet connections to the appliance.

To select the proper pump it is strongly recommended to consider the following:

- Need to know the required flow (GPM) and pressure drop for your appliance (see Table 8 or 9)
- Type of application, hydronic heating or Domestic Hot Water (DHW).
- **Copper or Copper Nickel Heat Exchanger:** For hydronic heating and DHW applications with normal water hardness choose a pump which will result in a temperature rise across the main heat exchanger of 30°F to 35 °F (17°C-19°C). If necessary use a flow setter valve to achieve the desired temperature rise.
- **Stainless Steel Heat Exchanger:** For hydronic heating and DHW applications with normal water hardness choose a pump which will result in a temperature rise across the main heat exchanger of 20°F to 25 °F (11°C-14°C). If necessary use a flow setter valve to achieve the desired temperature rise.
- For DHW applications with other than normal water hardness choose a pump for the local water hardness conditions. Alternatively run the pump continuously and soften the water to normal levels. Damage to the heat exchanger as a result of scaling or corrosive water conditions is non-warrantable.

#### 4.14.2 CIRCULATING PUMP SELECTION CONDENSOR

The operation of the circulating pump may be continuous or it may be in parallel with the main heat exchanger pump. Size the secondary pump for a minimum flow of 10% of the flow through the main heat exchanger and a maximum of 30% of the main heat exchanger flow up to 60 GPM.

## PART 5 ELECTRICAL & CONTROLS



IT IS EXTREMELY IMPORTANT THAT THIS UNIT BE PROPERLY GROUNDED!

### 5.1 ELECTRICAL CONNECTIONS

Table 11: Minimum Voltage Requirements

Model	Voltage Requirement	Maximum Over Current Protection	Full Load Amps
		[Amperes]	[Amperes]
500 - 1200	120VAC, 60Hz	15	7
1500 - 2000	120VAC, 60Hz	20	11
2500	120VAC, 60Hz	20	14
3000-4000	230VAC, 60Hz, Single Phase	20	16
4500-4504	230VAC, 60Hz, Single Phase*	30	24
5000, 5004, 6004	230VAC, 60Hz, 3 Phase**	30	17.8

\*This is a 4-wire power supply requiring two (2) lives, a neutral and a ground

\*\*This is a 5-wire power supply requiring three (3) lives, a neutral and a ground

DynaFlame® boilers supplied at 460/3/60 voltage, differ from the standard unit per the following:

#### CAUTION!

While working with 460V circuits it is imperative that extra precautions be taken

- Ensure that lock-out/ tag-out procedures are strictly enforced
- Only properly trained and authorized personnel should be permitted to work on live electrical circuits
- All electrical workers should be trained in electrical rescue techniques and CPR

Each unit has an internal factory mounted 500VA transformer to supply the single leg 115V necessary for the ignition circuit, which is factory mounted. The boiler itself is a single point power connection. A new Variable Frequency Drive replaces the standard VFD, and the combustion blower fan has been configured to operate at 460/3/60V (using the standard fan). Part numbers as well as FLA and MOC information is below.

500VA transformer: DC0500UH

VFD:	Model Range:
T232	DF-500 to DF-1200 (0.5hp)
T234	DF-1500 to DF-2000 (1hp)
T235	DF-2500 (1.5hp)
T237	DF-3000 to DF-4504 (3hp)
T238	DF-5004 to DF-6004 (5hp)

Model	Voltage Requirement	Maximum Over Current Protection	Full Load Amps
		[Amperes]	[Amperes]
500 - 1200	460VAC, 60Hz, 3 Phase	10	0.9
1500 - 2000			1.4
2500			1.8
3000			2.1
3500			3.5
4000 - 5004			5.3
6004			6.8

The combustion air fan motor operates on 230 VAC, 3 phase, 60 Hz. This three phase voltage is generated by the variable frequency drive (VFD) and supplied directly to the fan motor. The appliance, when installed, must be electrically grounded in accordance with the requirements of the authority having jurisdiction or in the absence of such requirements, with the latest edition of the National Electrical Code ANSI/NFPA No. 70. When the unit is installed in Canada, it must conform to the Canadian Electrical Code, C22.1, Part 1 and/or local Electrical Codes.

- All wiring between the appliance and field installed devices shall be made with wire having minimum 220°F (105°C) rating.
- Line voltage wire exterior to the appliance must be enclosed in approved conduit or approved metal clad cable.
- The pump must run continuously when appliance is being fired.
- To avoid serious damage, DO NOT ENERGIZE the appliance until the system is full of water. Ensure that all air is removed from the pump housing and piping before beginning initial operation. Serious damage may result if the appliance is operated without proper flow.
- Provide the appliance with proper overload protection.

### 5.2 VARIABLE FREQUENCY DRIVE (VFD)

This appliance uses a Variable Frequency Drive (VFD) which provides power to the combustion fan. The fan motor operates on 230VAC 3 phase power. This three phase voltage is generated by the VFD and supplied directly to the fan motor. The VFD receives a modulating signal (4-20 mA) from the local modulating control or a remote source based on water temperature to vary the frequency of the voltage supplied to the fan motor from 20 Hz up to 60 Hz. This varies the output of the combustion air fan from 20% up to 100% of capacity corresponding to the same variation in burner input. The VFD is driven towards 100% during the pre-purge portion of the start-up sequence. Once control self checks are completed, the VFD is provided with a signal to operate at soft start level for initial burner ignition. After main burner ignition is established, the modulating signal provided will use the VFD to vary the fan speed based VFD to vary the fan speed based on desired water temperature set point.

#### CAUTION

The voltage output from the variable frequency drive to the combustion air fan is 230VAC, 3 Phase. **AVOID** contact with high voltage wiring

### 5.3 DIFFERENTIAL AIR PRESSURE SWITCH

A normally open differential air pressure switch is used to prove operation of the combustion air fan. The pressure switch sensing points are installed at the fan outlet as the air moves into the inlet of the burner. One point measures total pressure (+air) and is connected to a pitot tube facing the flow from the fan paddle wheel. The other point measures static pressure. Differential pressure at the switch will be affected by blockages at the fan inlet or at the flue discharge. A minimum differential pressure across the sensing points of the pressure switch proves operation of the combustion air fan. This is set in the factory and may be adjusted for field conditions. The diagnostics display will exhibit a Status of no Air Flow when the differential pressure switch detects a sustained low air condition. This condition could be caused by a number of factors including:

- Sensing line broken or loose fitting.
- Dirty filter or blocked vent.
- Steady high wind condition exceeding 40 MPH.
- Incorrectly set switch.
- Missing bleed restrictor on total pressure side air line.

### 5.4 BLOCKED FLUE SWITCH

A normally closed block flue switch is used to shut down the appliance under the following conditions:

- 1) Air intake 50% blocked
- 2) Vent outlet 80% blocked

### 5.5 HIGH and LOW GAS PRESSURE SWITCHES (Optional)

A manual reset differential gas pressure switch is standard on models 3000 – 5000 and available as an option on models 500 - 2500. If differential gas pressure exceeds the maximum setting of the pressure switch, the appliance will shut down and an open gas pressure switch will be shown on the display. A low gas pressure switch is standard and monitors the minimum incoming gas supply pressure supplied to the gas train. If gas pressure falls below the minimum setting of the pressure switch, the appliance will shut down and an open gas pressure switch will be shown on the display.

### 5.6 HIGH LIMIT

A high limit aqua-stat control is located at the back of the appliance and the control bulb is installed in a dry well in the heat exchanger header outlet. The setting of this control limits maximum discharge water temperature. A manual reset high limit will have a red reset button which must be pushed whenever water temperature has exceeded the set point of the manual reset limit. The temperature of the water in the heat exchanger must drop a minimum of 15°F (8.3°C) below the setting of the high limit control before the reset function can be activated. Whenever an appliance is supplied with both an auto reset and manual reset high limit always set the auto reset limit 10°F (5.5°C) below the manual reset limit. This will prevent nuisance tripping of the manual reset.

## 5.7 DYNAFLAME® SOLA

DF500 – DF2500 models utilize a hot surface ignition system. DF3000 – DF6000 models utilize a proven pilot. The ignition control proves the presence of the flame using a flame rectification voltage (0.8Vdc), energizes the main gas valve, proves the presence of main burner flame, and provides for lockouts. The Alarm light will be lit on the ignition control module in the event of a fault.

**Figure 23: Ignition Module**

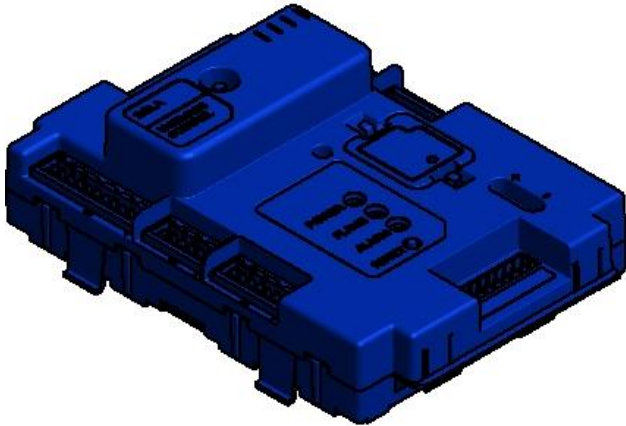

### 5.7.1 SERVICE PARTS

The electronic ignition module is not repairable. Any modification or repairs will invalidate the warranty and may create hazardous conditions that result in property damage, personal injury, fire, explosion and/or toxic gases. A faulty hot surface igniter or ignition module **MUST BE** replaced with a new factory approved unit only. A factory approved igniter, ignition control module and flame sensor for this specific unit is available from your local distributor. **DO NOT** use general purpose field replacement ignition modules, igniters or sensors. Each appliance has one ignition module, one hot surface igniter and one flame sensor.

### 5.7.2 IGNITION MODULE LOCKOUT FUNCTIONS

The ignition module may lockout in either a hard lockout condition requiring pushing of the reset button to recycle the control for a CSD1 requirement or a soft lockout condition which may be reset automatically once the error clears. A typical hard lockout fault can occur with single a trial for ignition CSD1 module. Pushing the reset button on the ignition control is the only way to reset an ignition module that is in a hard lockout condition. The reset button is located on the ignition module. Turning the main power "OFF" and then "ON" or cycling the thermostat will not reset a hard lockout condition. Wait until the display shows the temperatures on screen before pushing the reset button when the ignition module is in a hard lockout.

The DynaFlame Controller will go into an alert condition, for example, if the supply sensor is disconnected, flow switch, or air switch are not made. If the fault is not corrected, the boiler will stay in an alert condition. Once the fault is corrected, the boiler will automatically return to normal operating state.

## 5.8 DYNAFLAME CONTROLLER

**Table 12: Connector Description**

Connector	Connector Description
J1	Flame Sensor, Ground Rod
J2	Fan Modulation (DR300 – 1000)
J3	Display, Lead lag, Modbus Comm.
J4	24VAC Power, Pump, VFD
J5	Gas Valve, Safety Interlock String
J6	Safety Annunciation, Remote Operator
J8	24VAC Power, Inlet, Outlet Sensor
J9	DHW, Stack Sensor

### 5.9 ERROR TABLE

The following tables provide a description of all the possible errors with the DynaFlame appliance. Errors can be divided into two groups. Alert errors (will disappear when error is gone) and lockout errors (can only be reset by the RESET button).

When the control is in error the pump will be running. This is done to prevent the freezing of the central heating circuit when the boiler is in error during the winter period. For some non-volatile lockouts the pump will not be running, see table below for more details.

**Table 13: Lockout codes**

#	Description
1	Unconfigured safety data
2	Waiting for safety data verification
3-46	Internal Fault. Replace SOLA Controller
47	Flame rod to ground leakage
48	Static Flame
49	24VAC low/high
50	Modulation Fault
64	Fan speed not proved, ignition failure
67	Interlock Off, safety circuit is open
79	Heater Outlet high limit tripped
81	Delta T Limit
82	Stack limit tripped (PVC: 149°F, CPVC: 194°F, 250°F)
91	Inlet sensor fault
92	Outlet sensor fault
93	DHW sensor fault
94	Header sensor fault
95	Stack sensor fault
96	Outdoor sensor fault
105	Flame detected out of sequence
106	Flame lost if Main Flame Establishing Period (MFEP)
107	Flame lost early in run
108	Flame lost in run
109, 110	Ignition failed
112	Pilot test flame timeout
113	Flame circuit timeout
149	Flame detected

\* If an internal hardware error is detected contact Camus® technical support for troubleshooting procedure.

**Figure 24: Lockout Condition**

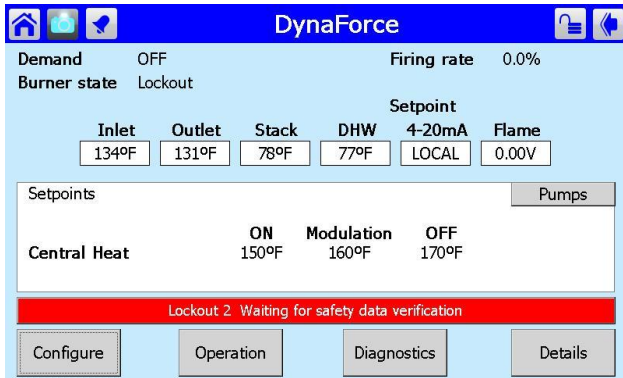

To eliminate the lockout error,

- 1) Press the red bar, indicating a Lockout condition
- 2) Press the **[Lockouts]** button

**Figure 25: Lockout History**



- 3) Press **[Clear Lockout]**

**Table 14: Alert/Hold Codes**

#	Description
29	Burner switch turned OFF
30	Burner switch turned ON
47	Invalid subsystem reset request occurred
61	Anti-short Cycle
62	Fan speed not proved
63	LCI off, safety circuit is open
68	Setpoint was overridden due to sensor fault
69	Modulation was overridden due to sensor fault
123	Modulation rate was limited due to outlet limit
124	Modulation rate was limited due to Delta-T limit
215	No Lead Lag slaves available to service demand
219	Using backup Lead Lag header sensor due to sensor failure
229	Lead lag slave communication timeout.
275-281	LCI off, safety circuit is open <ul style="list-style-type: none"> <li>- Thermal Disc in control box and/or upper cabinet</li> <li>- Flow Switch</li> <li>- LWCO</li> <li>- Blocked Flue Switch</li> </ul>
283	Demand off during measured purge time
291	Abnormal Recycle: Flame was not on at end of Ignition period
292	Abnormal Recycle: Flame was lost during Main Flame Establishing Period
293	Abnormal Recycle: Flame was lost early in Run
294	Abnormal Recycle: Flame was lost during Run
303-310+	Interlock Off, safety circuit is open <ul style="list-style-type: none"> <li>- Air Inlet Damper end switch</li> <li>- High Limit (Automatic/Manual)</li> <li>- Gas Pressure Switch (Low/High)</li> <li>- Low Air Proving Switch</li> </ul>
324, 374-379	Hardware flame bias. Flame sensor wire needs to be re-routed.
352+	Stack sensor fault
355+	Outlet sensor fault
357+	DHW sensor fault
359+	Inlet sensor fault
460	LCI lost in run
550	Delta T inlet/outlet limit was exceeded

\* If an internal hardware fault is detected contact Camus® technical support for troubleshooting procedure.

\* The alarm LED and alarm contacts are closed and will remain closed until the 'RESET' button is pressed.

## PART 6 SOLA CONTROL PANEL

### 6.1 APPLIANCE TEMPERATURE CONTROLLER

The appliance is provided with a control panel at the front. Operating controls are installed inside the control box and are accessible by undoing the two (2) slotted screws and swinging opening the door. The diagnostic information centre as well as the on/off switch and the appliance temperature controls reside on the control box door the ignition control module, VFD, transformer and relays are mounted on the internal panel.

Figure 26: Control Panel Front



The SOLA icons will appear in one of four colours indicating the boiler status:

Colour	Description
Blue	Normal Operation
Red	Lockout Condition
Yellow	Holding Mode
Grey	Communication Error

The Boiler Temperature Controller for this appliance is the Honeywell SOLA. It initiates the local call for heat and sets the target return (appliance inlet) water temperature. This controller offers a range of operation modes which provides set point as well as modulating control. It provides the following:

- Readings of inlet and outlet water temperatures as well as flame signal.
- Operation as an auto reset limit.
- Operation as a control for inlet water temperature, outlet temperature, system temperature.
- 40°F ΔT heat exchanger protection algorithm
- Available tank mounted sensor used in conjunction with inlet sensor.
- Adjustable; target temp, inter-stage differential, on delay between stages, minimum on time per stage, minimum off time per stage.
- Display of run hours for maintenance purposes. Counter wraps around at 10000 hours.
- Flame failure signal.
- JST and Molex connectors for ease of service.
- Error message display in text
- Manual override of boiler input rate for combustion
- Pump exercising feature runs pump 10 seconds every three days in the event of no pump operation.

### Levels of Access

Two levels of access to simplify the use of the boiler.

**User** – Access to general boiler and display settings and adjustments to the central heating and domestic hot water setpoint.

**Installer** – Access to all user parameters and allows for changes to additional boiler parameters to allow for ease of startup and serviceability.

#### NOTE

Due to the sensitivity of the touchscreen controller, using the backend of a pen/pencil is recommended for accuracy

Figure 27: Home Screen

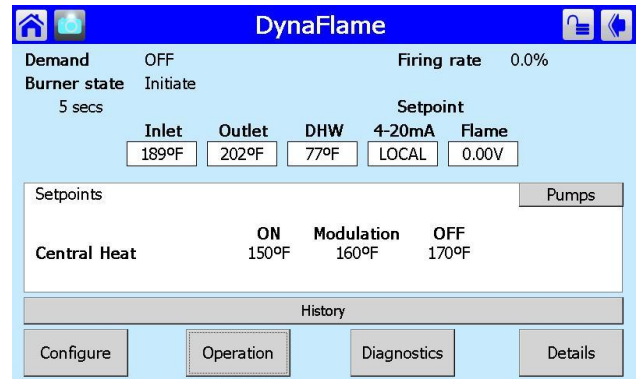

PARAMETER	DESCRIPTION
Demand	Central Heating (DRH)
	Domestic Hot Water (DRW)
Burner State	Current Status of DynaFlame®
Firing Rate	Target Firing Rate
Inlet	Inlet Water Temperature [°F]
Outlet	Outlet Water Temperature [°F]
Stack	Stack Temperature [°F]
DHW	DHW Temperature [°F] , if equipped
Lead Lag/ CH	Header Temperature [°F], if equipped
Outdoor	Outdoor Temperature [°F], if equipped
4-20mA	4-20mA input, if equipped

BUTTON	DESCRIPTION
Configure	Access DynaFlame® parameters (CH Parameters, DHW Parameters, Outdoor Reset, Pump Configuration etc.)
Operation	Details of boiler operation (Set point, Firing Rate, Pump Status, Safety circuit)
Diagnostics	Manual firing rate, Analog/ Digital Status
Details	History, Pump Status, Outlet Temperature



Sequence of Operation

# Troubleshooting

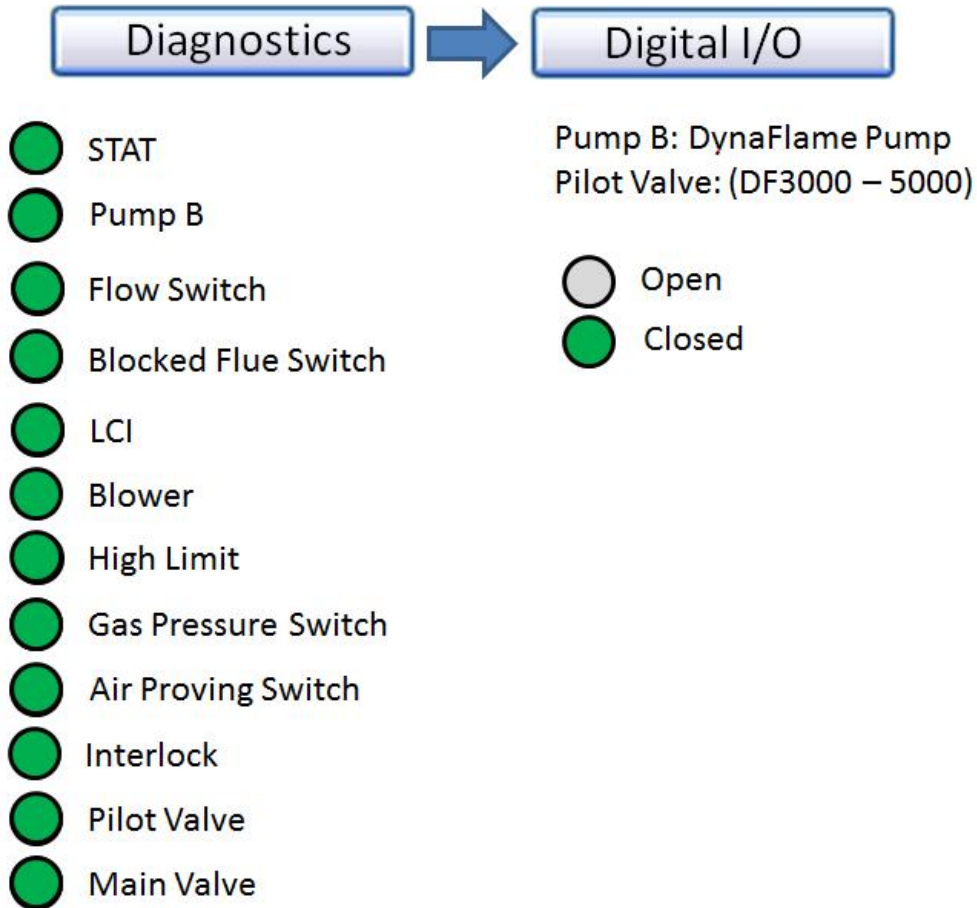

Flow Switch = Flow Switch, Low Water Cutoff (if equipped)

Gas Pressure Switch = Low gas pressure switch (4.5" w.c., N/O), High gas pressure switch (14" w.c., N/C)

Air Pressure Switch = Blocked flue switch (N/C), Air Proving Switch (N/O)

# DFH

## Modulation: Boiler Inlet, Boiler Fixed Setpoint Operation (Standalone)

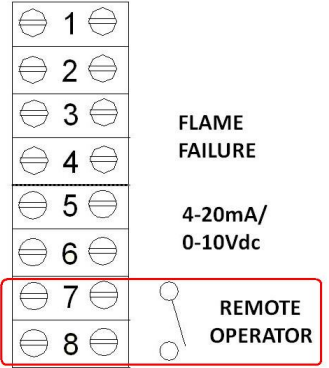
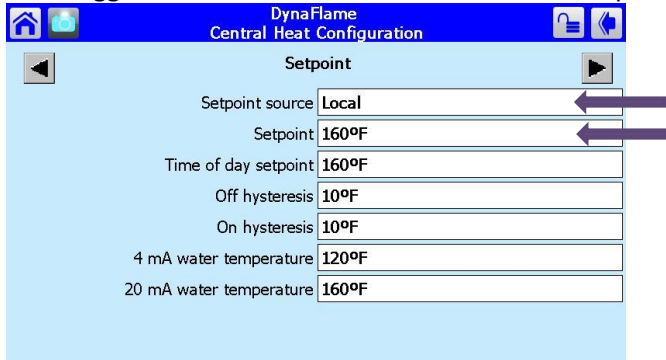
Description	Electrical Connection(s)	Programming Instructions
<ul style="list-style-type: none"> <li>Boiler operates at a fixed setpoint</li> <li>Modulates on boiler inlet sensor (default)</li> <li>Heat demand is generated when Remote Operator is closed.</li> </ul>	 <p>FLAME FAILURE 4-20mA/ 0-10Vdc</p> <p>REMOTE OPERATOR</p>	<ol style="list-style-type: none"> <li>Press <b>Configure</b> and <b>Login</b></li> <li>Press <b>[CH – Central Heat Configuration]</b></li> <li>Press the <b>▶</b> to arrive at <b>Setpoint</b></li> <li>Select <b>Setpoint source: Local</b></li> <li>Enter desired <b>Setpoint</b></li> <li>Place toggle switch to <b>REMOTE</b> for remote enable operation (if required)</li> </ol> 

Modulation: Boiler Inlet, Outdoor Reset Operation (Standalone)

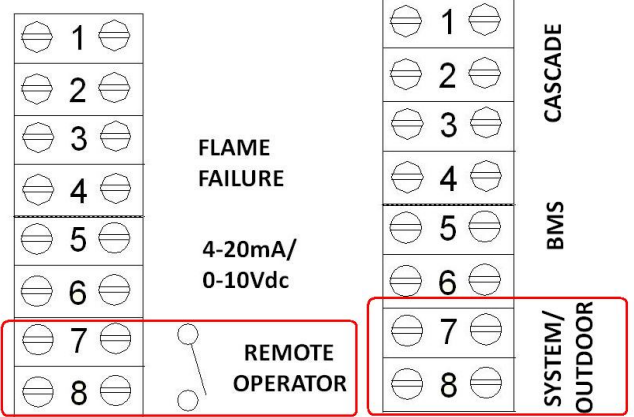
Description	Electrical Connection(s)	Programming Instructions
<ul style="list-style-type: none"> <li>Boiler operates with variable setpoint determined by outdoor reset curve</li> <li>Modulates on inlet sensor (default)</li> <li>Heat demand is generated when Remote Operator is closed.</li> </ul>		<ol style="list-style-type: none"> <li>Connect outdoor sensor to System/Outdoor contacts</li> <li>Press <b>Configure</b> and <b>Login</b></li> <li>Press <b>Outdoor Reset Configuration</b></li> <li>Press the <b>▶</b> to arrive at <b>Central Heat</b></li> <li>Select <b>Enable: Enable</b></li> <li>Select <b>Maximum outdoor temperature (WWSD)</b></li> <li>Select <b>Minimum outdoor temperature (Outdoor Design)</b></li> <li>Select <b>Low Water Temperature (Min. Water Temp.)</b></li> <li>Select <b>Outdoor boost maximum off point (Design Max.)</b></li> <li>Press <b>[CH – Central Heat Configuration]</b></li> <li>Press <b>Sensor Configuration</b></li> <li>Select <b>S5 (J8-11) Sensor</b></li> <li>Select <b>Connector Type: 10K NTC Single Non-Safety</b></li> <li><b>Outdoor temperature source = S5 (J8-11) sensor</b></li> <li>The control will proceed into a Lockout 2 condition</li> <li>Press <b>[Verify] &gt; [Begin] &gt; [Yes]</b></li> <li>Press the reset button on the ignition control within the allotted time</li> <li>Place toggle switch to <b>REMOTE</b> for remote operation (if required)</li> </ol>

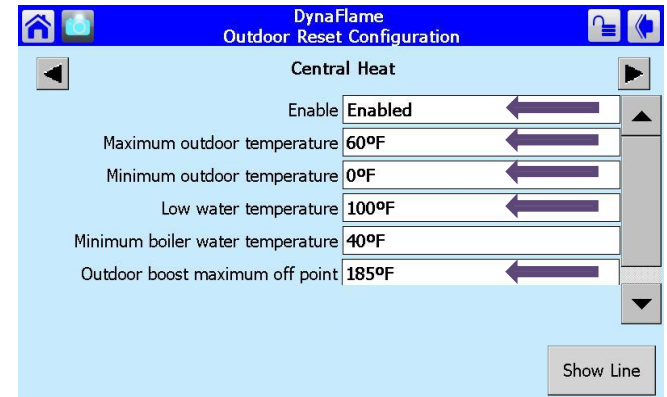

Modulation: System Sensor, Outdoor Reset Operation (Standalone)

NOTE: Outdoor Reset Module (PN: W8735S1000) required

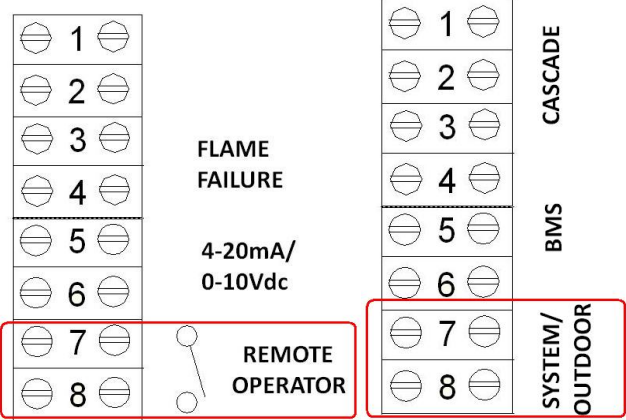
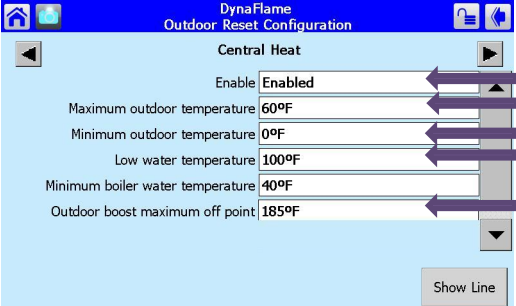
Description	Electrical Connection(s)	Programming Instructions
<ul style="list-style-type: none"> <li>Boiler operates with variable setpoint determined by outdoor reset curve</li> <li>Modulates on system sensor</li> <li>Heat demand is generated when Remote Operator is closed.</li> </ul>	 <p>The diagram shows a terminal block with 8 terminals. Terminals 1-6 are labeled 'CASCADE' and 'BMS'. Terminal 7 is labeled 'SYSTEM/OUTDOOR' and terminal 8 is labeled 'OUTDOOR'. A 'REMOTE OPERATOR' switch is connected to terminals 7 and 8. A 'FLAME FAILURE' signal is connected to terminals 3 and 4. A '4-20mA/0-10Vdc' signal is connected to terminals 5 and 6.</p>	<ol style="list-style-type: none"> <li>Connect Remote Operator</li> <li>Connect System sensor to System/Outdoor contacts</li> <li>Connect Outdoor Sensor to J3 ECOM connector</li> <li>Press <b>Configure</b> and <b>Login</b></li> <li>Press <b>Outdoor Reset Configuration</b></li> <li>Press the <b>Right Arrow</b> to arrive at <b>Central Heat</b></li> <li>Select <b>Enable: Enable</b></li> <li>Select <b>Maximum outdoor temperature (WWSD)</b></li> <li>Select <b>Minimum outdoor temperature (Outdoor Design)</b></li> <li>Select <b>Low Water Temperature (Min. Water Temp.)</b></li> <li>Select <b>Outdoor boost maximum off point (Design Max.)</b></li> </ol>  <p>The screenshot shows the 'DynaFlame Outdoor Reset Configuration' interface. Under 'Central Heat', the following settings are visible: Enable (Enabled), Maximum outdoor temperature (60°F), Minimum outdoor temperature (0°F), Low water temperature (100°F), Minimum boiler water temperature (40°F), and Outdoor boost maximum off point (185°F). A 'Show Line' button is at the bottom right.</p> <ol style="list-style-type: none"> <li>Press <b>Show Line</b> to confirm reset curve</li> <li>Press <b>Sensor Configuration</b></li> <li>Select <b>S5 (J8-11) sensor: 10K NTC single non-safety</b></li> <li>Select <b>Outdoor temperature source = EnviraCOM outdoor sensor</b></li> <li>Place toggle switch to <b>REMOTE</b> for remote enable operation (if required)</li> </ol>

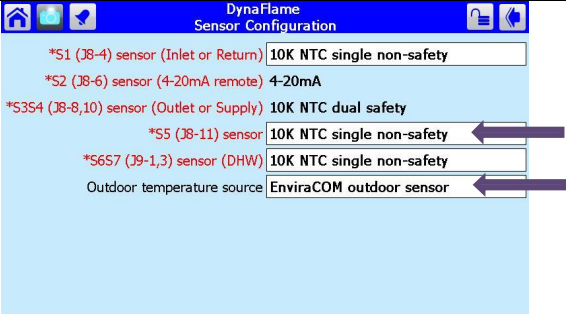
		 <p>DynaFlame Sensor Configuration</p> <ul style="list-style-type: none"> <li>*S1 (J8-4) sensor (Inlet or Return) 10K NTC single non-safety</li> <li>*S2 (J8-6) sensor (4-20mA remote) 4-20mA</li> <li>*S3S4 (J8-8,10) sensor (Outlet or Supply) 10K NTC dual safety</li> <li>*S5 (J8-11) sensor 10K NTC single non-safety</li> <li>*S6S7 (J9-1,3) sensor (DHW) 10K NTC single non-safety</li> <li>Outdoor temperature source EnviraCOM outdoor sensor</li> </ul>
--	--	--

4-20mA/ 0-10Vdc Setpoint Operation (Standalone, Lead Lag)

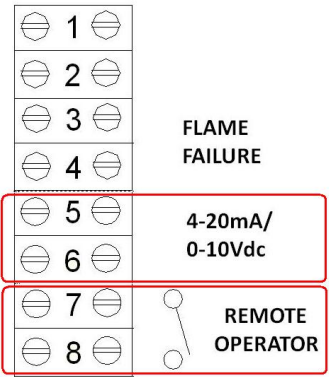
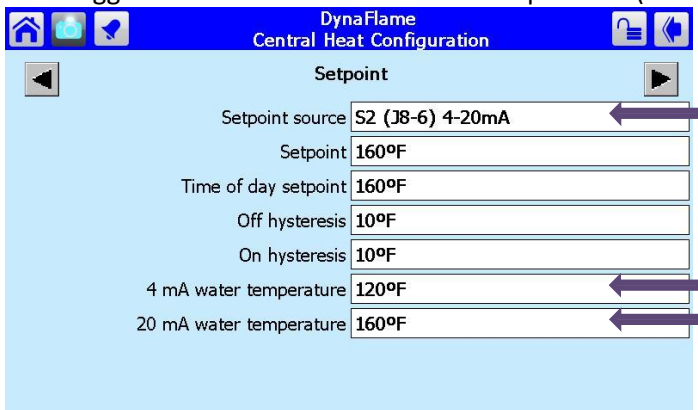
Description	Electrical Connection(s)	Programming Instructions
<ul style="list-style-type: none"> <li>Boiler operates with variable setpoint determined by 4-20mA incoming signal</li> <li>Modulates on boiler inlet sensor (default)</li> <li>Heat demand is generated when Remote Operator is closed and 4-20mA or 0-10Vdc signal is present.</li> </ul>	 <p>FLAME FAILURE</p> <p>4-20mA/ 0-10Vdc</p> <p>REMOTE OPERATOR</p>	<ol style="list-style-type: none"> <li>Press <b>Configure</b> and <b>Login</b></li> <li>Press <b>[CH – Central Heat Configuration]</b></li> <li>Press the <b>▶</b> to arrive at <b>Setpoint</b></li> <li>Select <b>Setpoint Source = S2 (J8-6) 4-20mA</b></li> <li>Select <b>4mA water temperature</b></li> <li>Select <b>20mA water temperature</b></li> <li>Place toggle switch to <b>REMOTE</b> for remote operation (if required)</li> </ol>  <p>DynaFlame Central Heat Configuration</p> <p>Setpoint</p> <ul style="list-style-type: none"> <li>Setpoint source S2 (J8-6) 4-20mA</li> <li>Setpoint 160°F</li> <li>Time of day setpoint 160°F</li> <li>Off hysteresis 10°F</li> <li>On hysteresis 10°F</li> <li>4 mA water temperature 120°F</li> <li>20 mA water temperature 160°F</li> </ul>

4-20mA/ 0-10Vdc Firing Rate Operation (Standalone, Lead Lag)

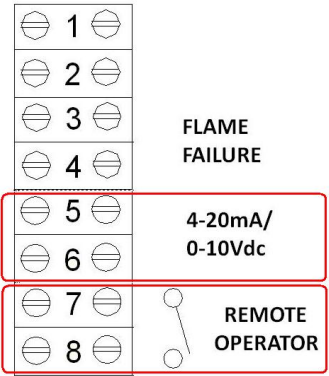
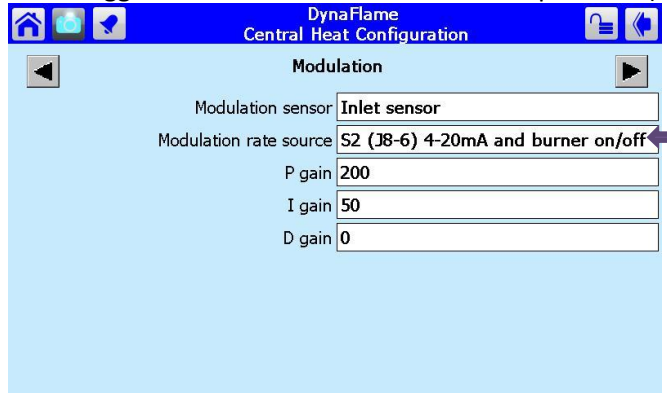

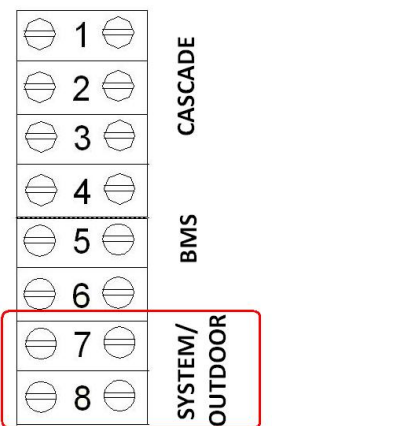
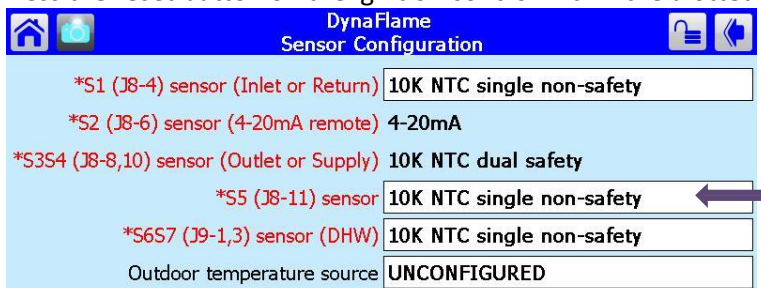

Description	Electrical Connection(s)	Programming Instructions
<ul style="list-style-type: none"> <li>Boiler operates with variable setpoint determined by 4-20mA incoming signal</li> <li>Modulates on header sensor</li> <li>Heat demand is generated when Remote Operator is closed and 4-20mA or 0-10Vdc signal is present.</li> </ul>		<ol style="list-style-type: none"> <li>Press <b>Configure</b> and <b>Login</b></li> <li>Press <b>[Lead Lag Master Configuration]</b></li> <li>Press <b>[Advanced Settings &gt;]</b></li> <li>Press the <b>▶</b> to arrive at <b>Central Heat</b></li> <li>Select <b>Modulation rate source = S2 (J8-6) 4-20mA and burner on/off</b></li> <li>Place toggle switch to <b>REMOTE</b> for remote operation (if required)</li> </ol> 

System Sensor Enable (Standalone)

Description	Electrical Connection(s)	Programming Instructions
<ul style="list-style-type: none"> <li>Method to enable system sensor for Standalone applications</li> </ul>		<ol style="list-style-type: none"> <li>Press <b>Configure</b> and <b>Login</b></li> <li>Press <b>[Sensor Configuration]</b></li> <li>Select <b>S5 (J8-11) Sensor: 10K NTC Single Non-Safety</b></li> <li>The control will proceed into a Lockout 2 condition</li> <li>Press <b>[Verify] &gt; [Begin] &gt; [Yes]</b></li> <li>Press the reset button on the ignition control within the allotted time</li> </ol> 

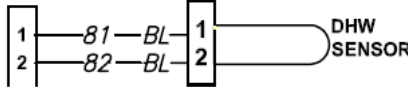
## DFW

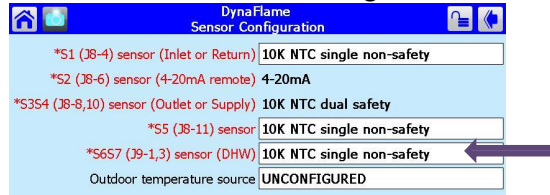
### Modulation: Boiler Inlet, Fixed Setpoint Operation (Standalone, Lead Lag)

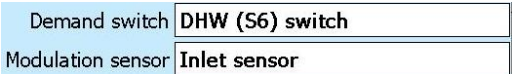
Description	Electrical Connection(s)	Programming Instructions
<ul style="list-style-type: none"> <li>Boiler operates at a fixed DHW setpoint</li> <li>Modulates on boiler inlet sensor (default)</li> <li>Heat demand is generated when Remote Operator is closed.</li> </ul>	<p>DHW Sensor/ Stat, if required.</p> 	<ol style="list-style-type: none"> <li>Press <b>Configure</b> and <b>Login</b></li> </ol> <p><u>Inlet Sensor operation</u></p> <ol style="list-style-type: none"> <li>Press [<b>DHW – Domestic Hot Water Configuration</b>]</li> <li>Select <b>Demand Switch: Modulation sensor only</b></li> <li>Select <b>Modulation sensor: Inlet Sensor</b>. Proceed to Step 12</li> </ol>  <p><u>DHW Sensor/Stat operation</u></p> <ol style="list-style-type: none"> <li>Press [<b>Sensor Configuration</b>]</li> <li>Select <b>S6S7 (J9-1,3) Sensor: 10K NTC Single Non-Safety</b></li> <li>The control will proceed into a Lockout 2 condition</li> <li>Press [<b>Verify</b>] &gt; [<b>Begin</b>] &gt; [<b>Yes</b>]</li> <li>Press the reset button on the ignition control within the allotted time</li> </ol>  <p><u>DHW Sensor operation</u></p> <ol style="list-style-type: none"> <li>Press [<b>DHW – Domestic Hot Water Configuration</b>]</li> <li>Select <b>Demand Switch: Modulation sensor only</b></li> <li>Select <b>Modulation sensor: DHW Sensor</b>. Proceed to Step 12</li> </ol>  <p><u>DHW Stat operation</u></p> <ol style="list-style-type: none"> <li>Press [<b>DHW – Domestic Hot Water Configuration</b>]</li> <li>Select <b>Demand Switch: Modulation sensor only</b></li> <li>Select <b>Modulation sensor: DHW (S6) switch &amp; inlet sensor</b></li> </ol>  <ol style="list-style-type: none"> <li>Enter desired <b>Setpoint</b></li> <li>Place toggle switch setting to <b>REMOTE</b> for remote operation (if required)</li> </ol>

DynaFlame  
Domestic Hot Water Configuration

DHW enable	Enabled
Demand switch	Modulation sensor only
Modulation sensor	Inlet sensor
Setpoint	120°F
Off hysteresis	10°F
On hysteresis	10°F
DHW priority override time	0 sec
P gain	200



## DF(H,W) Lead Lag Operation

### Master Boiler

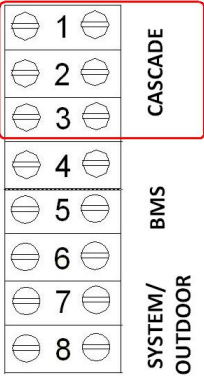
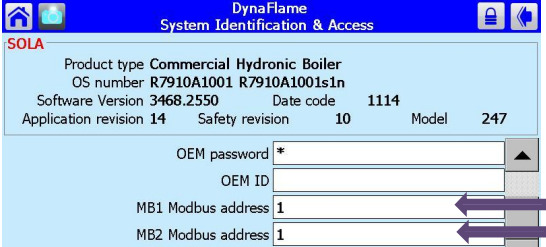
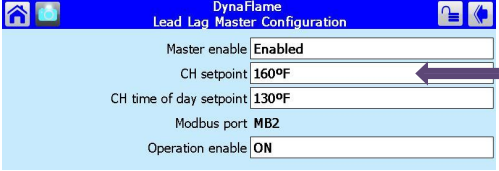
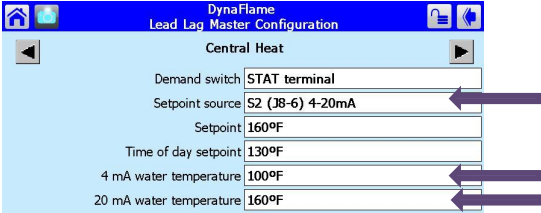
Description	Electrical Connection(s)	Programming Instructions
<ul style="list-style-type: none"> <li>Master boiler lead lag setup</li> </ul>		<ol style="list-style-type: none"> <li>Press <b>Configure</b> and <b>Login</b></li> <li>Select <b>System Identification &amp; Access</b></li> <li>Verify <b>MB1 Modbus address = 1</b></li> <li>Verify <b>MB2 Modbus address = 1</b></li> </ol>  <ol style="list-style-type: none"> <li>Select <b>Lead Lag Master Configuration</b></li> <li>Select <b>Master Enabled = Enabled</b> <u>Fixed Setpoint operation</u></li> <li>Enter <b>CH Setpoint (Fixed setpoint)</b> <u>4-20mA/ 0-10Vdc setpoint operation</u></li> <li>Select <b>[Advanced Settings &gt;]</b></li> <li>Press the <b>▶</b> to arrive at <b>Central Heat</b></li> <li>Select <b>Setpoint Source = S2 (J8-6) 4-20mA</b></li> <li>Select <b>4mA water temperature</b></li> <li>Select <b>20mA water temperature</b></li> </ol>   <ol style="list-style-type: none"> <li>Select <b>Lead Lag Slave Configuration</b></li> <li>Select <b>Slave enabled = Enable slave for built-in Lead Lag master</b></li> </ol>

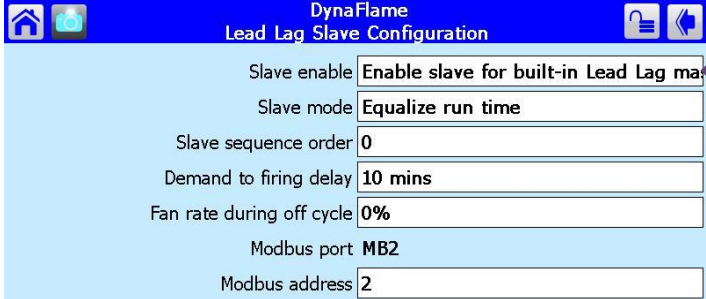
		 <p>The following steps are performed at the factory and verifying on site will be sufficient:</p> <ol style="list-style-type: none"> <li>15) Select <b>Pump Configuration</b></li> <li>16) Press <b>[Advanced Options &gt;&gt;]</b></li> <li>17) Press the <b>▶</b> to arrive at <b>Central Heat Pump</b> or <b>DHW Pump</b></li> <li>18) On Options: <input checked="" type="checkbox"/> Local burner demand</li> <li>19) On Options: Local Lead Lag <input checked="" type="checkbox"/> Service Active</li> <li>20) Force On: <input checked="" type="checkbox"/> Outlet high limit</li> </ol>
--	--	--

Slave Boiler

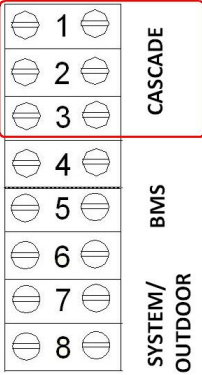
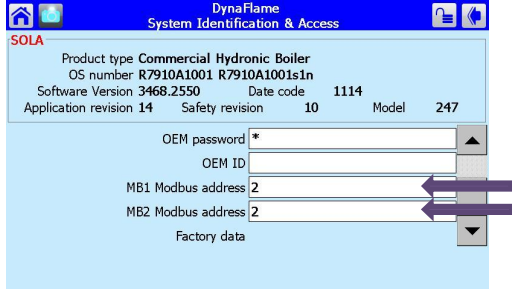

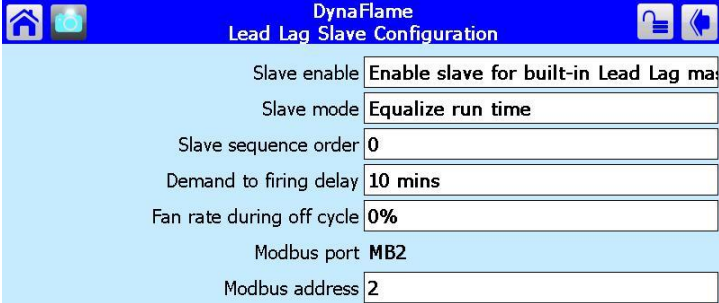

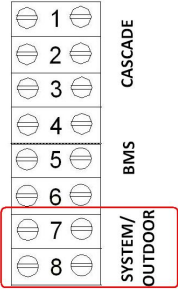
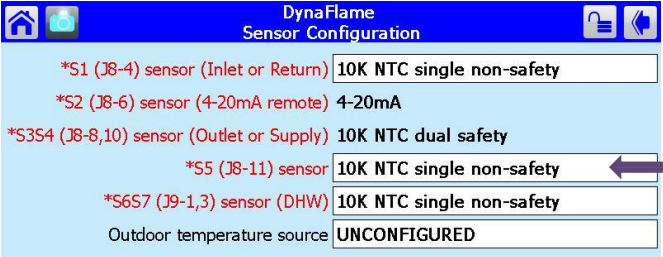

Description	Electrical Connection(s)	Programming Instructions
<ul style="list-style-type: none"> <li>• Slave boiler lead lag setup</li> </ul>		<ol style="list-style-type: none"> <li>1) Press <b>Configure</b> and <b>Login</b></li> <li>2) Select <b>System Identification &amp; Access</b></li> <li>3) Verify <b>Modbus address</b>. To be in sequential order</li> </ol>  <ol style="list-style-type: none"> <li>4) Select <b>Lead Lag Slave Configuration</b></li> <li>5) Select <b>Slave Enabled = Enable slave for built-in Lead Lag master</b></li> </ol>

		 <p>The following steps are performed at the factory and verifying on site will be sufficient:</p> <ol style="list-style-type: none"> <li>6) Select <b>Pump Configuration</b></li> <li>7) Press <b>[Advanced Options &gt;&gt;]</b></li> <li>8) Press the <b>▶</b> to arrive at <b>Central Heat Pump</b> or <b>DHW Pump</b></li> <li>9) On Options: <input checked="" type="checkbox"/> Local burner demand</li> <li>10) On Options: Local Lead Lag <input checked="" type="checkbox"/> Service Active</li> <li>11) Force On: <input checked="" type="checkbox"/> Outlet high limit</li> </ol>
--	--	--

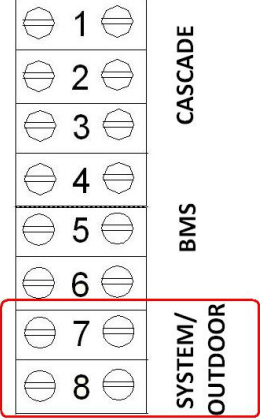
Master Boiler, System Sensor

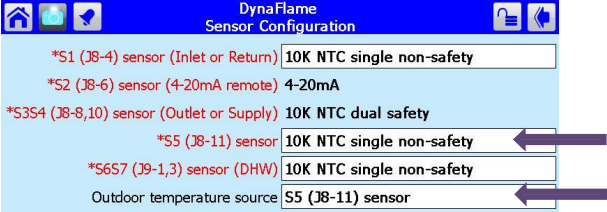
Description	Electrical Connection(s)	Programming Instructions
<ul style="list-style-type: none"> <li>• Master boiler system sensor configuration</li> </ul>		<ol style="list-style-type: none"> <li>1) Press <b>Configure</b> and <b>Login</b></li> <li>2) Press <b>[Sensor Configuration]</b></li> <li>3) Select <b>S5 (J8-11) Sensor</b></li> <li>4) Connector Type: <b>10K NTC Single Non-Safety</b></li> </ol>  <ol style="list-style-type: none"> <li>5) The control will proceed into a Lockout 2 condition</li> <li>6) Press <b>[Verify] &gt; [Begin] &gt; [Yes]</b></li> <li>7) Press the reset button on the ignition control within the allotted time</li> </ol>

Outdoor Sensor connected to Slave boiler 2 (DRH ONLY)

Description	Electrical Connection(s)	Programming Instructions
<ul style="list-style-type: none"> <li>Slave boiler outdoor sensor configuration</li> <li>When done correctly, the outdoor temperature will be shown on the Master boiler</li> </ul>		<p><b>Slave Boiler</b></p> <ol style="list-style-type: none"> <li>Press  and </li> <li>Press <b>[Sensor Configuration]</b></li> <li>Select <b>S5 (J8-11) Sensor</b></li> <li>Connector Type: <b>10K NTC Single Non-Safety</b></li> </ol>  <ol style="list-style-type: none"> <li>The control will proceed into a Lockout 2 condition</li> <li>Press <b>[Verify] &gt; [Begin] &gt; [Yes]</b></li> <li>Press the reset button on the ignition control within the allotted time</li> </ol> <p><b>Master Boiler</b></p> <ol style="list-style-type: none"> <li>Press  and </li> <li>Press <b>[Lead Lag Master Configuration]</b></li> <li>Press <b>[Advanced Settings &gt;]</b></li> <li>Press the  to arrive at <b>Outdoor Reset</b></li> <li>Select <b>Enable: Enabled</b></li> <li>Select <b>Maximum outdoor temperature (WWSD)</b></li> <li>Select <b>Minimum outdoor temperature (Outdoor Design)</b></li> <li>Select <b>Low Water Temperature (Min. Water Temp)</b></li> <li>Select <b>Outdoor boost maximum off point (Design Max.)</b></li> </ol>

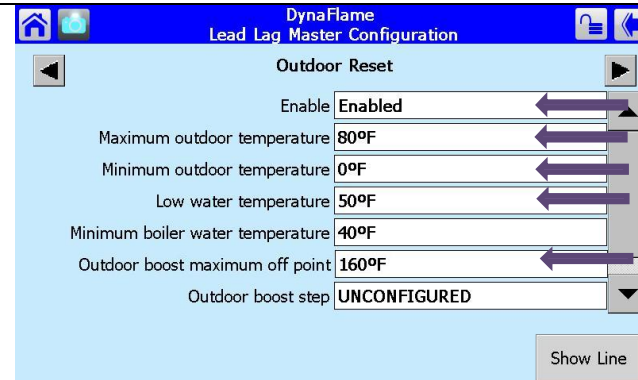

- 17) Press [**Show Line**] to confirm reset curve
- 18) Press the **▶** to arrive at **Warm Weather Shutdown**
- 19) Select **Enable = Shutdown after demand ends**

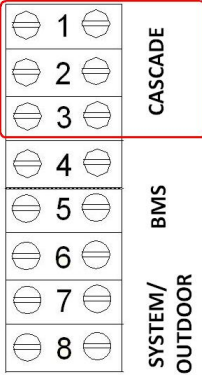
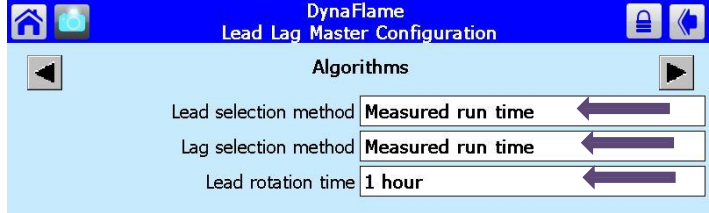

Rotation schedule adjustment

Description	Electrical Connection(s)	Programming Instructions
<ul style="list-style-type: none"> <li>Standard rotation schedule is based on equalizing run time on a 1-hour schedule</li> <li>To vary the rotation to a fixed schedule based on (hours, days)</li> </ul>		<ol style="list-style-type: none"> <li>Press <b>Configure</b> and <b>Login</b></li> <li>Press [<b>Lead Lag Master Configuration</b>]</li> <li>Press [<b>Advanced Settings &gt;</b>]</li> <li>Press the <b>▶</b> to arrive at <b>Algorithms</b></li> <li>Select <b>Lead selection method: Sequence order</b></li> <li>Select <b>Lag selection method: Sequence order</b></li> <li>Select <b>Lead rotation time: (user defined)</b></li> </ol> 

Base load rate adjustment

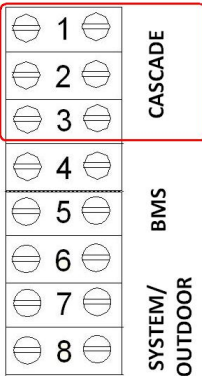
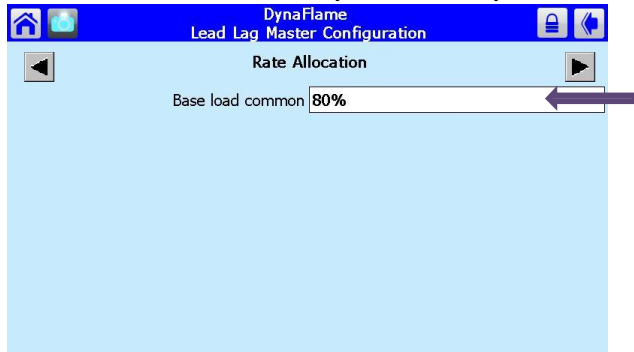
Description	Electrical Connection(s)	Programming Instructions
<ul style="list-style-type: none"> <li>Upon a call for heat the lead boiler will fire up to the specified base load rate (80%). If the temperature is not within Error threshold (5°F) of setpoint after Interstage delay (2 minutes) a lag boiler will be brought online and will also fire up to the base load rate specified.</li> <li>Modulation of boilers will only occur after all boilers in the Lead Lag system are firing up to the specified base load rate (80%).</li> </ul>		<ol style="list-style-type: none"> <li>Press <b>Configure</b> and <b>Login</b></li> <li>Press [<b>Lead Lag Master Configuration</b>]</li> <li>Press [<b>Advanced Settings &gt;</b>]</li> <li>Press the <b>▶</b> to arrive at <b>Rate Allocation</b></li> <li>Select <b>Base load common: (user defined)</b></li> </ol> 

Adjust staging of boilers

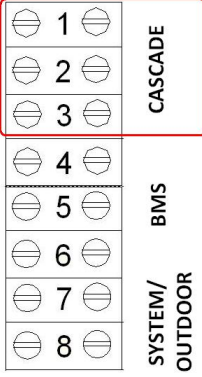
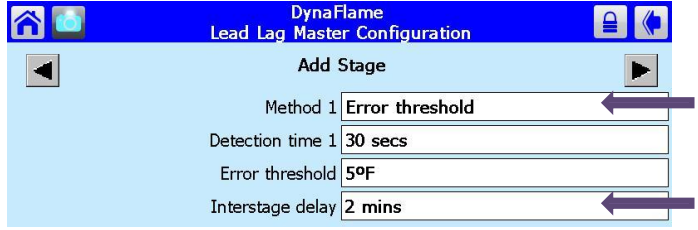
Description	Electrical Connection(s)	Programming Instructions
<ul style="list-style-type: none"> <li>Upon a call for heat the lead boiler will fire up to the specified base load rate (80%). If the temperature is not within Error threshold (5°F) of setpoint after Interstage delay (2 minutes) a lag boiler will be brought online and will also fire up to the base load rate specified.</li> <li>This method will then be repeated for the next lag boiler, if available.</li> </ul>		<ol style="list-style-type: none"> <li>Press <b>Configure</b> and <b>Login</b></li> <li>Press <b>[Lead Lag Master Configuration]</b></li> <li>Press <b>[Advanced Settings &gt;]</b></li> <li>Press the <b>▶</b> to arrive at <b>Add Stage</b></li> <li>Select <b>Error threshold</b></li> <li>Select <b>Interstage delay</b></li> </ol> 

## 6.2 CONFIGURE MENU

Figure 28: Configure Menu

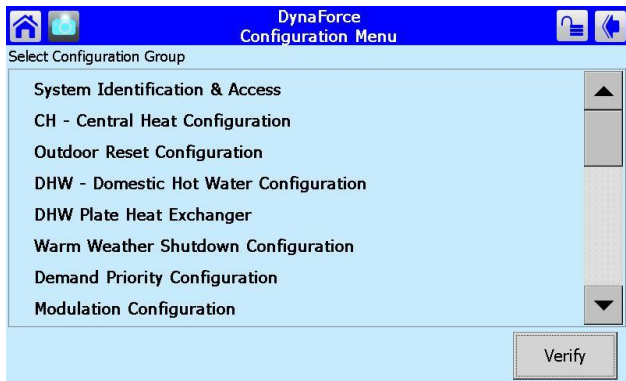

### 6.2.1 System Identification & Access

Menu Group Selection	Parameter	Description
System Identification & Access	Product Type	Commercial Hydronic Boiler
	OS number	Part Number of SOLA Controller
	Software Version	Software version
	Date Code:	Release date of software
	Boiler Name	DynaFlame® Model Number
	Installation	Type of application

### 6.2.2 Pump Configuration

Menu Group Selection	Sub-Menu Group Selection	Parameter	Selection	Description	
Pump Configuration	Central Heat Pump	Pump Control	Auto	Assigns the method for SOLA to control a Central Heating pump (Default: Auto, Pump is activated whenever a call for heat is present)	
			ON	ON: Pump is constantly powered	
		Pump Output	Pump B	Specify pump contact	
		Over run time	1..5 min	Post pump time (Default: 1 min)	
		Use for local (Stand-alone) demands	✓		
		Use for Lead Lag Master demands	✓		
	Boiler Pump	Pump Control	Auto	Refer to above (Default)	
			ON	Refer to above	
		Pump Output	Pump A	Specify pump contact	
		Over run time	1..5 min	Post pump time (Default: 1 min)	
		Use for local (Stand-alone) demands	✓		
		Use for Lead Lag Master demands	✓		
	Pump Configuration	DHW Pump	Pump Control	Auto	Refer to above (Default)
				ON	ON: Pump is constantly powered
Pump Output			Pump B	Specify pump contact	
Over run time		1..5 min	Post pump time (Default: 1 min)		
System Pump		Pump Control	Auto	Refer to above (Default)	
			ON	ON: Pump is constantly powered	
		Pump Output	None	Specify pump contact	
	Over run time	1..5 min	Post pump time (Default: 1 min)		



### 6.2.3 Statistics Configuration

Menu Group Selection	Sub-Menu Group Selection	Parameter	Selection	Description
		Boiler pump cycles		Displays the number of cycles the boiler pump has been activated
		Burner cycles		Displays the number of cycles the burner has been activated
		Burner run time		Displays burner run time in hours
		CH pump cycles		Displays the number of cycles the CH pump has been activated
		DHW pump cycles		Displays the number of cycles the DHW pump has been activated
		System pump cycles		Displays the number of cycles the system pump has been activated

### 6.2.4 Burner Control Timing and Rates

Figure 29: Burner Control Timing and Rates

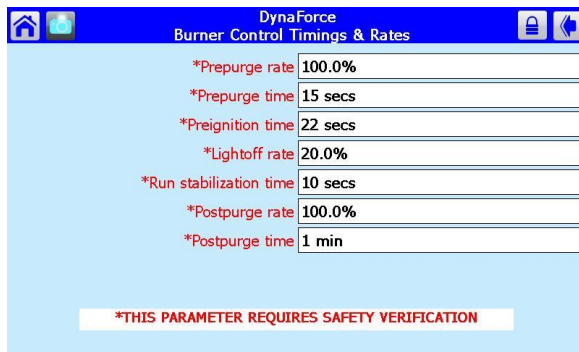

Menu Group Selection	Sub-Menu Group Selection	Parameter	Selection	Description
Burner Control Timing and Rates		Prepurge rate	100.0%	Prepurge fan speed (Default: DF0500 – 6004: 100.0%)
		Prepurge time	30 sec.. 5 mins	Prepurge time (Default: 15 sec)
		Run Stabilization Time	10 sec	Main flame establishing period
		Postpurge rate	100.0%	Postpurge fan speed (Default: DF0500 – 6004: 100.0%)
		Postpurge time	30 sec.. 5 mins	Postpurge time (Default 1 min)

### 6.2.5 Burner Control Ignition

Menu Group Selection	Sub-Menu Group Selection	Parameter	Selection	Description
Burner Control Ignition		Lightoff rate	DF0500 – 6004: 20.0%	Ignition Fan speed

### 6.2.6

### Sensor Configuration

Menu Group Selection	Sub-Menu Group Selection	Parameter	Selection	Description
Sensor Configurations		S1 (J8-4) sensor	10K NTC single non-safety	Inlet Sensor
		S2 (J8-6) sensor	4-20mA	4-20mA Input Signal
		S3S4 (J8-8, 10) sensor	10K NTC dual safety	Outlet Sensor
		S5 (J8-11) sensor	10K NTC single non-safety	Outdoor Sensor: Standalone boiler or Slave boiler Header sensor: Master boiler
		S6S7 (J9-1,3) sensor	10K NTC single non-safety	DHW Sensor (DRW Only)
		S8S9 (J9-4,6) sensor	10K NTC single non-safety	Stack Sensor

### 6.3 LEAD LAG SETUP

The following components are needed for a Lead Lag setup

- 1) 10kΩ System Sensor

Turn off all the boilers before beginning the setup process.

To setup the DynaFlame® Lead Lag system follow the instructions:

#### System Sensor

Insert the supplied 10kΩ system sensor into the building loop. The wires coming out of the system sensor should be connected to Sys/Outdr terminals in the junction box.

#### NOTE

The use of a system sensor is required in lead lag operation.

- 1) When variable speed main circulators **ARE NOT** used the system sensor is to be placed into the return system piping.
- 2) When variable speed main circulators are used the system sensor is to be placed into the supply system piping.

All SOLA controllers are programmed with a default address of 1. The address of the slave controllers in the system must have a unique address (1..8).

#### Sequence of Operation:

When a boiler is set as Lead Lag Master = Enabled and Modbus address = 1, the controller of this boiler will drive the lead lag operation.

The outdoor temperature sensor connected to the slave boiler 2 (ie. B-2) will be the outdoor sensor for the lead lag system

- The system temperature sensor connected to boiler 1 in terminals labeled “Outdr/Sys” in the junction box will be the control sensor for lead lag operation.
- The start/stop signal connected to boiler 1 at terminals labeled “Remote Operator” will be the heat demand input for lead lag operation.

When demand for heat is present the lead boiler will start and uses the lead lag parameters for boiler modulation. After a period of “Interstage delay” the master boiler compares the lead lag temperature with the lead lag set point and will check if:

- 1) **An additional boiler is needed**  
Lead lag temp < Lead lag setpoint – Add stage  
Error threshold
- 2) **Number of boilers remain the same**  
Lead lag temp > Lead lag setpoint – Add stage  
Error threshold **AND**  
Lead lag temp < Lead lag setpoint + Drop stage  
Error threshold
- 3) **A boiler should stop**  
Lead lag temp > Lead lag setpoint + Drop stage  
Error threshold
- 4) **All boilers off**  
Lead lag temp > Lead lag setpoint + off hysteresis

If the lead lag master system is interrupted the remaining boilers will operate as standalone boilers based on the Central Heat or DHW parameters when set to “Enabled”.

#### Rotation

Rotation time is configurable based on equalized run time (default) or a fixed rotation schedule.

#### Interstage Delay

The length of time to wait between requesting a slave SOLA to fire and detecting that it has failed to start. (Default: 2 minutes)

#### Base Load Rate

When a call for heat is initiated the lead boiler runs at the desired base load rate (Default: 80%) and continues to operate in this fashion based on the above 4 scenarios. If the lead lag temperature is not satisfied a second boiler is fired at they would both operate at 80% fire rate.

#### Slave State

Slave Status Manager	
Unknown	Table entry is unused or empty
Available	Slave is operational and ready to use
Add Stage	Stage is getting ready to fire
Suspend Stage	Stage was getting ready but is not needed
Disabled	Slave is locked out or disabled
Recovering	Slave is in time delay to verify that it is operational before considered to be available

#### Wiring the Lead Lag Setup

Use Cascade terminals in the junction box to wire lead lag appliances

	Master	Slave 2	..	Slave 7
J3, MB2	A	A	..	A
	B	B	..	B
	C	C	..	C

Figure 30: Lead lag Wiring Setup (Left: Master, Right: Slave)

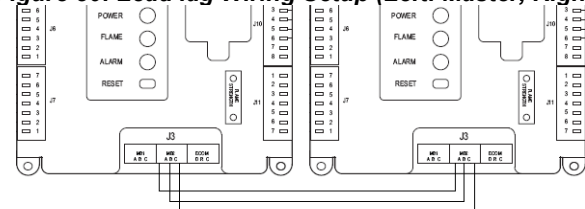

#### NOTE

Recycle power on all boilers after programming is complete if lag boilers are not discovered automatically

#### NOTE

CH Setpoint or DHW Setpoint must match Setpoint located in Lead Lag Master Configuration in order for the system to operate correctly.

#### NOTE

The Local/Remote switch (explained below) must be set in the “Local” position on ALL lag boilers.

## 6.5 LOCAL/REMOTE SWITCH

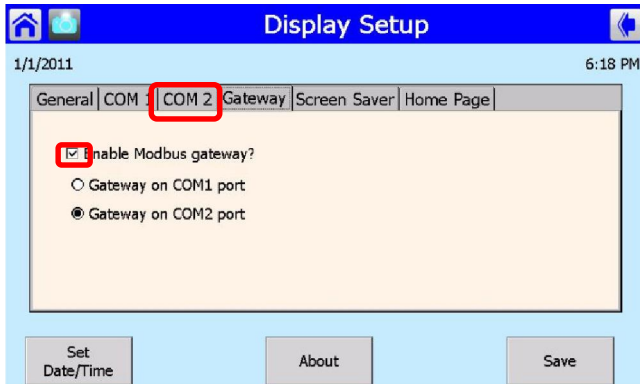

The local remote switch mounted inside the control box is designed to deliver an enable signal either relying on an external contact closure (Remote) or enabling the boiler locally (local). When Remote is selected via the SPDT switch the Remote Operator contacts in the junction box must close to deliver an enable signal. When Local is selected via the SPDT switch a constant enable signal is present. When troubleshooting the DynaFlame® it is recommended to switch to Local mode.

## 6.6 COMM. PORT 2 ACTIVATION



- 1) Select Gateway tab
- 2) Check Enable Modbus gateway
- 3) Select Gateway on COM2 port

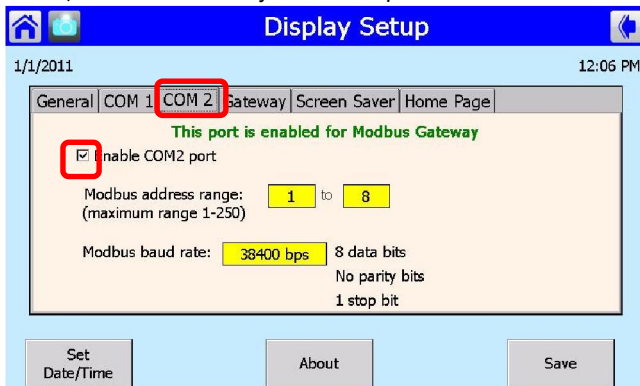

- 1) Select COM2 tab
- 2) Check Enable COM2 port

### Verify activity on COM2 port

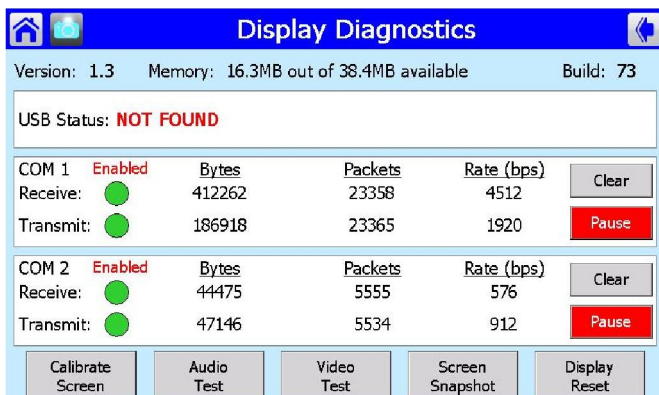

COM1: Modbus data between display and SOLA  
 COM2: Modbus data between display and front end (Modbus) or Protonode  
 For more instructions on interfacing with Modbus/ Bacnet/ LonWorks/ Metasys N2 network:



[http://www.camus-hydraulics.com/media/1257/93\\_0238\\_dynaflame\\_dynaforce\\_dynamaxhs\\_advantus\\_protocol\\_setup.pdf](http://www.camus-hydraulics.com/media/1257/93_0238_dynaflame_dynaforce_dynamaxhs_advantus_protocol_setup.pdf)

## 6.7 VARIABLE FREQUENCY DRIVE

The variable frequency drive (VFD) has a factory set security code which has to be entered before any adjustments can be made. The VFD has 50 parameters, which can be adjusted. At present only the following are pertinent:

**Table 13: Variable Frequency Drive Parameters**

Parameter #	Function	Settings
1	High/Low Voltage Input Voltage 120, 220-240, 460-480	01 02
2	Carrier Frequency	03
4	Stop Method	03
5	Standard Speed Source	04
19	Acceleration Time	120 sec
20	Deceleration Time	60 sec
28	Fixed Boost	1.0
36	Preset Speed	29
38	Skip Bandwidth	3.0
45	Speed at Minimum Signal	Consult factory test sticker
46	Speed at Maximum Signal	Consult factory test sticker
50	Fault History	View Only
51 thru 58	Miscellaneous	View Only

## 6.8 FROST PROTECTION

The DynaFlame® with SOLA control panel is equipped with a heat exchanger frost protection algorithm where if the boiler inlet or outlet temperature sensors drop below 41°F (5°C) the boiler pump is enabled. If the temperature continues to drop to 38°F (3.3°C) the burner will be fired to bring the inlet and outlet temperatures to 50°F (10°C) to prevent freezing of the heat exchanger.

## PART 7 COMPONENTS

### 7.1 HOT SURFACE IGNITER (GLOW BAR)

The silicon carbide igniter is inserted directly through the fan flange and held in place by two screws. A hold down bracket as well as sealing gasket above and below the igniter assures a good seal. Care must be taken when removing and/or installing the igniter since the silicon carbide element is brittle. Always remove the igniter prior to removing the fan assembly for inspection of the burner and heat exchanger. Properly prepared igniter will have a bead of silicone sealing the end mounting bracket to the ceramic shaft.

Figure 31: Hot Surface Igniter

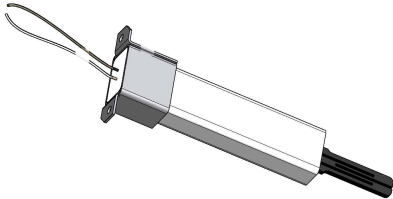

During trial for ignition a properly operating igniter will generate a minimum  $3.2 \pm 0.2A$  which is the current required for reliable ignition. It is recommended that the hot surface igniter be replaced every 4,000 hours of appliance operation to maintain peak ignition efficiency.

### 7.2 FLAME SENSOR

The flame sensor is inserted directly through the fan flange and is screwed into the fan flange. Care must be taken, when installing the flame sensor, to align it perpendicular to the fan flange and parallel to the burner tube and not to over tighten. Always remove the flame sensor prior to removing the fan assembly for inspection of the burner and heat exchanger.

Figure 32: Flame Sensor

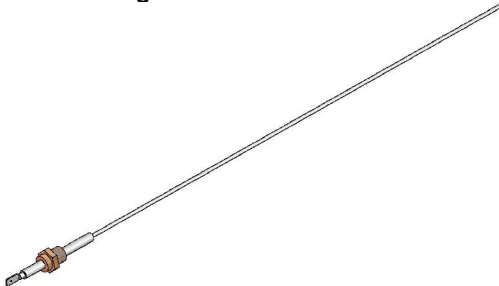

The ignition module relies on the flame sensor to provide a flame rectification signal. Oxide deposits, improper placement or damaged ceramic insulator will result in insufficient signal leading to ignition module lock out. For proper operation minimum 0.8Vdc must be fed back to the module. Oxide deposit on the sensor rod must be removed with steel-wool. Do not use sand-paper since this will contaminate the surface.

### 7.3 COMBUSTION AIR FAN

Figure 33: Fan, Burner, Hot Surface Igniter and Flame Sensor Arrangement

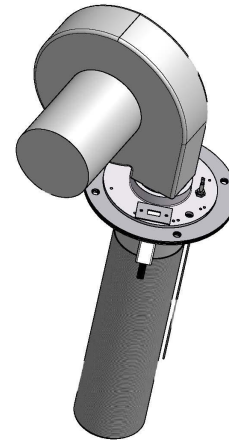

DynaFlame® uses a sealed air fan to provide combustible air/gas mix to the burner and push the products of combustion through the heat exchanger and venting system. The fan assembly consists of a sealed housing and fan wheel constructed from spark resistant cast aluminum. The fan is operated by a fully enclosed 230 VAC, 3 Phase electric motor. The fan housing and motor assembly is fully sealed and SHOULD NOT be field serviced. The power draw of the motor is proportional to the modulated gas input rate of the appliance.

### 7.4 INNER JACKET

The inner jacket assembly is constructed from a special corrosion resistant stainless steel. This includes both the primary heat exchanger chamber and the secondary heat exchanger chamber. All screws and fasteners used for assembly of the inner jacket and secondary heat exchanger chamber are also stainless steel.

**DO NOT mix stainless steel and standard plated fasteners when disassembling and reassembling the inner jacket sheet metal components. Standard plated fasteners will be damaged by the flue product condensate when used on the inner jacket assemblies.**

### 7.5 OUTER JACKET

The outer jacket assembly is constructed from mirror finish stainless Steel. This ensures a long life for the jacket assembly, with full integrity

### 7.6 VENTING TRANSITION

All appliances are shipped with a rectangular to round stainless steel adapter. Depending on the appliance category an increaser will be required for the proper vent configuration. Please refer to Table 5 dimensions and specifications.

When installing Category II or IV appliances care must be taken to properly seal all joints and provide slope for drainage of condensate.

## PART 8 FIELD STARTUP PROCEDURE

### 8.1 CHECKING THE INSTALLATION

- Inspect the connections for water, gas and electricity.
- Confirm that water is being pumped toward the heat exchanger inlet. Never pump away from the exchanger since this will result in a low-pressure zone, which will allow localized boiling and result in heat exchanger damage.
- Power to the boiler and pump must be from the same circuit to prevent the boiler firing in case the pump is inadvertently shut off.
- Inlet gas pressure must be a minimum of 3" W.C. for natural gas and 11" W.C. for propane.
- With the boiler off, open the main gas supply valve and vent the trapped air from the piping leading to the boiler. Confirm that all gas connections to the heater are tight and that there are no missing test plugs.
- Connect a manometer to obtain the differential air pressure between negative and positive ports. See Figure 11.
- The air/gas ratio controller automatically adjusts to match the air signal on the gas side. In this way true mass flow control of air/gas mix is achieved. All boilers are test fired and factory set. A test sticker with actual reading is affixed to the unit.

### 8.2 CHECKING THE CONSTRUCTION

- Check the boiler wiring to see that it agrees with the wiring diagram supplied.
- Confirm that all terminal strips and field connections are identified.
- Confirm that the SOLA control is set in the proper mode. Auto reset limits are fixed in all modes of operation.
- With the firing valve in the off position, switch on power to the boiler. The fan motor will accelerate until the airflow light energizes. If a light remains off past the STAT light, the ignition sequence will not proceed.
- Once all lights past the STAT are energized the ignition module will try for ignition. When the igniter is hot enough, the ratio gas valve actuator is energized and if ignition is accomplished the Burner State changes to Run. If ignition is not accomplished, two more ignition trials will be made 15 seconds apart. The control will then proceed to lockout and must be reset by momentarily interrupting power. It is normal during initial start up, when air is being purged from the piping, to require two to three tries before successful ignition.
- With the boiler running, check for flue gas leaks along the inner cabinet joints and around the flue outlet. Some minor leakage is acceptable.
- Repair any major leaks prior to the next step.
- At the factory adjustments were made to achieve proper input and acceptable burner performance at full input and at minimum input.
- Depending on field conditions, the CO<sub>2</sub> trim valve may require some minor adjustment at full input. Refer to Figure 11. Always set the appliance for a CO<sub>2</sub> level in the range of 7.5% to 8.5% at full fire and 7.0% to 7.5% at low for fire for non-condensing units. For condensing units CO<sub>2</sub> may be set in the range of 8.5% to 9.0% at

full fire and 7.5% to 8.0% at low fire. For propane, reading will be approximately 1.5% higher. Adjustment at minimum input can be done at the low fire adjustment screw by first removing the brass cap. Turning adjustment screw clockwise will increase CO<sub>2</sub>.

### 8.3 FIRE TESTING

- This boiler is designed for low fire soft start. At the start of trial for ignition the fan will decelerate to minimum fire and will light off at low fire before ramping up towards full input depending on the 4 – 20 mA signal from the controller.
- Shut power off to the heater and open the firing valve. Switch power back on and allow the burner to fire. Ignition should be smooth. Normally the differential gas pressure will be identical to the differential air pressure. Actual differential pressure may vary from the numbers on the test label due to the field conditions and sample variations. Always make adjustments to meet the recommended CO<sub>2</sub> levels. Adjust high fire first followed by low fire adjustment.

Table 15: Combustion Values

Non-Condensing DynaFlame®				
	Natural Gas		Propane	
	CO <sub>2</sub>	CO	CO <sub>2</sub>	CO
Max. Fire	7.5% - 8.5%	<100 PPM	9.0% - 10.0%	<100 PPM
Min. Fire	7.0% - 7.5%	<100 PPM	8.5% - 9.0%	<100 PPM
Near-Condensing DynaFlame®				
	Natural Gas		Propane	
	CO <sub>2</sub>	CO	CO <sub>2</sub>	CO
Max. Fire	8.0% - 8.5%	<100 PPM	9.5% - 10.0%	<100 PPM
Min. Fire	7.5% - 8.0%	<100 PPM	9.0% - 9.5%	<100 PPM
Condensing DynaFlame®				
	Natural Gas		Propane	
	CO <sub>2</sub>	CO	CO <sub>2</sub>	CO
Max. Fire	8.5% - 9.0%	<100 PPM	10.0% - 11.5%	<100 PPM
Min. Fire	7.5% - 8.0%	<100 PPM	9.0% - 9.5%	<100 PPM
Alternate Stainless Steel Heat Exchangers Non-Condensing & Near-Condensing DynaFlame®				
	Natural Gas		Propane	
	CO <sub>2</sub>	CO	CO <sub>2</sub>	CO
Max. Fire	8.0% - 9.0%	<100 PPM	9.5% - 11.5%	<100 PPM
Min. Fire	8.0% - 9.0%	<100 PPM	9.5% - 10.5%	<100 PPM

**Figure 34: DF 500 – 1750 Gas Valve**

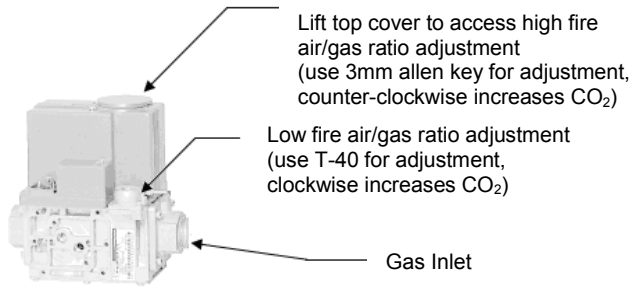



**To adjust the high-fire setting (DF 500 – 1750)**

Use the DynaFlame® Control Panel:

- 1) Press **[DIAGNOSTICS]** button
- 2) Press **[Diagnostic Tests]** button
- 3) Move the firing rate slider to maximum firing rate as indicated by the test sticker
- 4) Press **[Start Test]** to operate the boiler at max fire for 5 minutes.

Locate the input adjustment screw on the top side of the gas valve.

	Increase CO2	Decrease CO2
<b>High Fire Adjustment</b>	 Counter-Clock Wise	 Clockwise



After adjusting the screw wait a moment for the combustion levels to stabilize before attempting to make any further adjustments. Continue this procedure until combustion levels are satisfied.

**To adjust the low fire setting (DF 500 – 1750)**

Use the DynaFlame® Control Panel:

- 1) Press **[DIAGNOSTICS]** button
- 2) Press **[Diagnostic Tests]** button
- 3) Move the firing rate slider to minimum firing rate
- 4) Press **[Start Test]** to operate the boiler at min fire for 5 minutes.

The DynaFlame® should respond immediately and fire at minimum firing rate. When this is achieved locate the low fire adjustment screw as illustrated above.

	Increase CO2	Decrease CO2
<b>Low Fire Adjustment</b>	 Clockwise	 Counter-Clock Wise

When the correct combustion values are achieved replace the screw cap back on to the gas valve.

- This boiler is designed for low fire soft start. At the start of trial for ignition the fan will decelerate to minimum fire and will light off at low fire before ramping up towards full input through the PWM or 4-20mA signal from the controller.

- Shut power off to the heater and open the firing valve. Switch power back on and allow the burner to fire. Ignition should be smooth. Always make adjustments to meet the recommended CO<sub>2</sub> levels. Adjust high fire first followed by low fire adjustment.

**To adjust the high-fire setting (DF 2000 – 6004)**

One or more manometers should be connected to the DynaFlame® before proceeding to the next step to monitor the air and gas signal. Refer to Section 3.7 of this manual for details on connecting manometers.

Use the DynaFlame® Control Panel:

- 1) Press **[DIAGNOSTICS]** button
- 2) Press **[Diagnostic Tests]** button
- 3) Move the firing rate slider to 100.0%
- 4) Press **[Start Test]** to operate the boiler at max fire for 5 minutes.

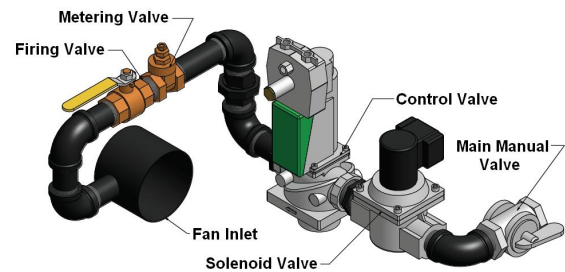

**Figure 35: DF2000 – 3000 Gas Train Layout**

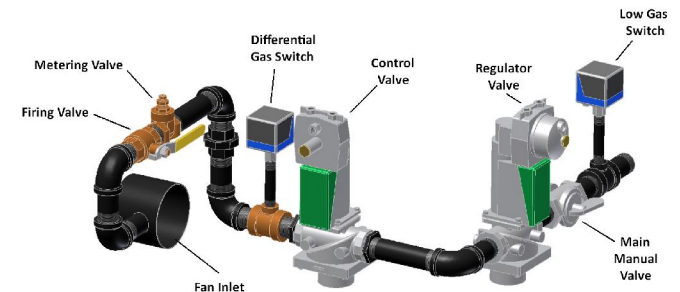

**Figure 36: DF3500 – 6004 Gas Train Layout**



Locate the metering valve on the gas train.

	Increase CO2	Decrease CO2
<b>High Fire Adjustment</b>	 Counter-Clock Wise	 Clockwise

Turn the screw 1/8 turn in either way for each adjustment to keep track of the adjustments. After adjusting the screw wait a moment for the combustion levels to stabilize before attempting to make any further adjustments. Continue this procedure until combustion levels are satisfied.

To adjust the low-fire setting (DF 2000 – 6004)

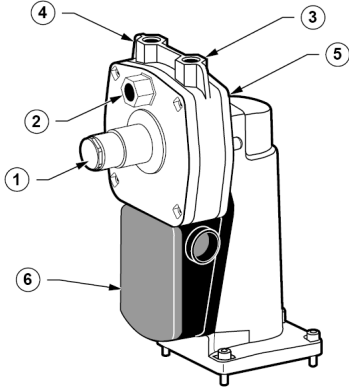

**Figure 37: SKP 55 Gas Valve**



- 1 Adjustment of low fire bias
- 2 Connection for air pressure (+) sensing line
- 3 Connection for the air pressure (-) sensing line
- 4 Connection for the gas pressure (-) sensing line
- 5 Connection for the gas pressure (+) sensing line
- 6 Position indicator

Use the DynaFlame Control Panel

- 1) Press **[DIAGNOSTICS]** button
- 2) Press **[Diagnostic Tests]** button
- 3) Move the firing rate slider to 20.0%
- 4) Press **[Start Test]** to operate the boiler at min fire for 5 minutes.

	Increase CO <sub>2</sub>	Decrease CO <sub>2</sub>
<b>Low Fire Adjustment</b>	 Clockwise	 Counter-Clock Wise

When the correct combustion values are achieved replace the screw cap back on to the gas valve.

To reset the trim valve to factory settings refer to the chart below and the step-by-step instructions that follow.

**Table 16: Inline trim valve setting**

Model	LP Gas (Propane)	Natural Gas	VFD Hz (High Fire)
	# of Turns Clockwise	# of Turns Clockwise	
DF 500	3 1/2	2 1/2	Consult Factory Test Sticker
DF 750	3	1 1/2	
DF 1100	3	1 1/2	
DF 1200	3	1 1/2	
DF 1500	4	3	
DF 1750	4	3	
DF 2000	3 3/4	2 1/2	
DF 2500	3 5/8	2 7/8	
DF 3000	4	3	
DF 3500	5 3/4	4	
DF 4000	5 7/8	5	
DF 4500	7 3/4	5	
DF 5000	7 3/4	5	
DF 6000	7 3/4	5	

**Step 1:** Fully open inline metering valve (counter-clockwise)

**Step 2:** Close inline metering valve to preset level

**Step 3:** Above table shows initial settings only, fine-tuning will be required with the use of an analyzer

- This boiler is designed for low fire soft start. At the start of trial for ignition the fan will decelerate to minimum fire and will light off at low fire before ramping up towards full input through the 4-20mA from the controller.
- Shut power off to the heater and open the firing valve. Switch power back on and allow the burner to fire. Ignition should be smooth. Normally the differential gas pressure will be identical to the differential air pressure. Actual differential pressure may vary from the numbers on the test label due to the field conditions and sample variations. Always make adjustments to meet the recommended CO<sub>2</sub> levels. Adjust high fire first followed by low fire adjustment.
- Allow the water temperature to rise so that the heater cycles on the operator.
- Check the temperature rise across the heat exchanger. For hydronic applications and for domestic hot water, a rise exceeding 30°F is not normally recommended.

- **Stainless Steel Heat Exchanger:** Allow the unit to cycle on the limit. This can be done by gradually restricting outlet water flow. The auto reset limits are set at 210°F for domestic hot water and hydronic heating
- **Copper, Copper-Nickel Heat Exchanger:** Allow the unit to cycle on the limit. This can be done by gradually restricting outlet water flow. The auto reset limits are set at 200°F for domestic hot water and 230°F for hydronic heating utilizing a copper heat exchanger. In addition the heaters are equipped with a manual reset high limit set at 210°F for domestic hot water and 250°F for hydronic heating.

- At full input, block 50% of the fan inlet opening. The display should show 'LCI not closed'. If it does not, slowly turn the adjustment on the normally closed blocked flue switch counter clockwise until the blocked flue indicator energizes.
- Check the air proving switch. Remove the restriction from the fan inlet and reset the power on the control panel. A properly set air switch will cause the Low Air Switch indicator to turn green at a fan speed between 15Hz and 20Hz on the VFD.
- Check the ignition retries circuit.
- Shut the main gas off to the unit and allow it to try for ignition. Trial for ignition should commence within 30 seconds.
- Allow the water temperature to rise so that the heater cycles on the operator.

#### **8.4 COMMISSIONING APPLIANCE**

- Remove manometers and replace inlet gas pressure test plug.
- Fill out start up report for each heater. Be sure to record all settings and readings. Retain a copy of report for future reference.
- Start up is now complete and heater may be placed into service.



## PART 9 TROUBLE SHOOTING

COMPONENT	FAILURE MODE	ANALYSIS
<b>Incoming Power</b>	<ul style="list-style-type: none"> <li>Two wires interchanged</li> </ul>	<ul style="list-style-type: none"> <li>No effect on safety</li> <li>Live and Neutral wires are interchanged.</li> </ul>
<b>Transformer Tripped</b>	<ul style="list-style-type: none"> <li>The 24Volts and 120 Volts wired are interchanged</li> <li>Alert: 49</li> <li>Lockout: 53</li> </ul>	<ul style="list-style-type: none"> <li>Breaker on transformer trips</li> </ul>
<b>Relief Valve</b>	<ul style="list-style-type: none"> <li>System pressure exceeds relief valve setting</li> </ul>	<ul style="list-style-type: none"> <li>Replace the standard relief valve with a higher rated valve up to the maximum pressure of the heat exchanger.</li> <li>Improperly sized expansion tank.</li> </ul>
<b>Flow Switch</b>	<ul style="list-style-type: none"> <li>Flow Switch contacts are open</li> <li>Alert: 63, 275-281, 460</li> <li>LCI OFF</li> </ul>	<ul style="list-style-type: none"> <li>Verify that pump is operating</li> <li>Verify for closed valves or obstructions in boiler piping</li> <li>Verify that all air has been purged from the system</li> <li>Verify that wiring is correct</li> </ul>
<b>Flame Failure</b>	<ul style="list-style-type: none"> <li>The boiler has failed to ignite the burner</li> <li>Alert: 110, 291-294</li> </ul>	<ul style="list-style-type: none"> <li>To reset the module refer to section 5.8.2</li> <li>Verify that all air has been purged from gas line</li> <li>Inspect hot surface igniter and related wiring for damage and connection errors</li> <li>DF 500 – 2500: Verify igniter is glowing</li> <li>DF 3000 – 6000: Verify pilot is lit</li> <li>Inspect flame sensor and associated wiring. Replace if necessary</li> <li>Verify that boiler is properly grounded</li> <li>Verify incoming gas supply pressure and that it coincides with Table 7.</li> <li>Verify that the vent/ air inlet piping (if equipped) are correctly installed and obstructions are not present.</li> <li>Verify 24 VAC (DF 500 – 1200) and 115VAC (DF 1400 – 6000) is being supplied to the gas valve relay from the DynaFlame Controller during ignition. Check wiring from DynaFlame Controller and Gas Valve Relay. If a signal cannot be detected, the DynaFlame Controller needs to be replaced</li> <li>If 24 VAC is present, check the outlet of the valve to ensure that gas is flowing. When the valve is energized a change in pressure should occur, if no change is detected the gas valve has failed to open or it is passing insufficient amount of gas. If this is an initial startup increase the low fire gas setting by ¼ turn clockwise.</li> <li>Inspect the burner. Refer to Burner Maintenance in section 10.5</li> <li>Replace the DynaFlame Controller, if necessary</li> </ul>

COMPONENT	FAILURE MODE	ANALYSIS
<b>Flame Disappears During a Run Cycle</b>	<ul style="list-style-type: none"> <li>The DynaFlame boiler was running and flame signal suddenly disappeared.</li> <li>Lockout: 106, 107, 108, 109</li> </ul>	<ul style="list-style-type: none"> <li>Verify that all air has been purged from gas line</li> <li>Verify that boiler is properly grounded</li> <li>Inspect flame sensor and associated wiring. Replace if necessary</li> <li>Check for flame sensor cracks in the insulator or continuity to ground</li> <li>Adjust the air proving switch. Turn counter-clockwise to reduce sensitivity</li> <li>Adjust the blocked flue switch. Turn clockwise to reduce sensitivity</li> <li>Verify incoming gas supply pressure and that it coincides with Table 7.</li> <li>Verify that the gas line connections to the boiler are adequate. Refer to Table 6.</li> <li>Verify that the vent/ air inlet piping (if equipped) are correctly installed and obstructions are not present</li> <li>Verify that 24 VAC is being supplied to the gas valve during operation. If a signal cannot be detected, the transformer needs to be replaced</li> <li>Inspect the burner. Refer to Burner Maintenance in section 10.5</li> <li>Replace the DynaFlame Controller if necessary</li> </ul>
<b>Noisy Operation</b>	<ul style="list-style-type: none"> <li>Supply Gas Issue</li> </ul>	<ul style="list-style-type: none"> <li>Refer to Part 3 Gas Connection in this manual.</li> <li>Natural Gas Pressure reads between 3" w.c. and 14" w.c.</li> <li>L.P. Gas Pressure should be at 11" w.c.</li> </ul>
	<ul style="list-style-type: none"> <li>Air/Gas Mixture Issue</li> </ul>	<ul style="list-style-type: none"> <li>Refer to Section 8.3 Fire Testing for proper combustion setting.</li> </ul>
	<ul style="list-style-type: none"> <li>Air Inlet and/or Vent configuration</li> </ul>	<ul style="list-style-type: none"> <li>Refer to Part 2 Air Inlet and Venting</li> </ul>
	<ul style="list-style-type: none"> <li>Dirty/ Damaged Burner</li> </ul>	<ul style="list-style-type: none"> <li>Refer to Burner Maintenance in section 10.5 of this manual for the burner removal and inspection procedure. Clean or replace the burner, if required.</li> </ul>
	<ul style="list-style-type: none"> <li>Fan is vibrating</li> </ul>	<ul style="list-style-type: none"> <li>Check that all fan bolts are torqued to 20 lb-ft.</li> </ul>
	<ul style="list-style-type: none"> <li>Air in the piping system</li> </ul>	<ul style="list-style-type: none"> <li>Purge all air from the piping system</li> </ul>
<b>Auto Reset High Limit Trips</b>	<ul style="list-style-type: none"> <li>The outlet temperature has exceeded the set point temperature specified.</li> <li>Alert: 67, 79, 137, 303-310</li> <li>ILK OFF</li> </ul>	<ul style="list-style-type: none"> <li>Verify that the system is full of water and that all air has been properly purged from the system.</li> <li>Verify that <math>\Delta T</math> does not exceed 30°F across the heat exchanger</li> <li>Verify that the boiler is piped properly.</li> <li>Verify that 120VAC is being supplied to the boiler pump on a call for heat. If voltage cannot be detected check wiring.</li> <li>Verify that the pump is circulating when 120VAC is detected. If not, pump impeller may be stuck. Use a flat head screwdriver on face of pump to turn impeller manually</li> <li>If 120VAC is present during a call for heat, but the pump still does not circulate, replace the pump.</li> <li>Replace the main DynaFlame Controller if necessary</li> </ul>

SYMPTOM	FAILURE MODE	ANALYSIS
<b>Manual Reset High Limit Trips (if equipped)</b>	<ul style="list-style-type: none"> <li>Manual Reset Safety High Limit tripped, outlet temperature in excess of 210°F</li> <li>Alert: 63, 67, 79, 137, 276-281, 303-309</li> <li>ILK OFF</li> </ul>	<ul style="list-style-type: none"> <li>Verify that the capillary tube is broken. If this is the case, replace Manual Reset High Limit</li> <li>Verify that the system is full of water and that all air has been properly purged from the system.</li> <li>Verify that the boiler is piped properly.</li> <li>Verify that 120 VAC is being supplied to the boiler pump on a call for heat. If voltage cannot be detected check wiring.</li> <li>Verify that the pump is circulating when 120 VAC is supplied. If so, pump impeller may be stuck. Use a flat head screwdriver on face of pump to turn impeller manually.</li> <li>If 120 VAC is present during a call for heat, but the pump still does not circulate, replace pump.</li> </ul>
<b>Delta-T Limit Tripped</b>	<ul style="list-style-type: none"> <li>Outlet temperature has exceeded 40°F over inlet temperature</li> <li>Alert: 124</li> </ul>	<ul style="list-style-type: none"> <li>Verify that the system is full of water and that all air has been properly purged from the system.</li> <li>Verify that the boiler is piped properly.</li> <li>Verify that 120VAC is being supplied to the boiler pump on a call for heat. If voltage cannot be detected check wiring.</li> <li>Verify that the pump is circulating when 120VAC is detected. If not, pump impeller may be stuck. Use a flat head screwdriver on face of pump to turn impeller manually</li> <li>If 120VAC is present during a call for heat, but the pump still does not circulate, replace the pump.</li> <li>Purge all air from the piping</li> <li>Verify boiler water pressure exceeds 30 PSI</li> </ul>
<b>Temperature Overshoot</b>	<ul style="list-style-type: none"> <li>Stack temperature has exceeded the limit temperature.</li> <li>Alert: 125</li> </ul>	<ul style="list-style-type: none"> <li>The stack temperature has exceeded the maximum temperature allowed.</li> <li>PVC: 149°F</li> <li>CPVC: 194°F</li> <li>AL29-4C, Stainless Steel: 250°F</li> <li>Measure the resistance of the flue sensor at room temperature, it should be approximately 10kΩ.</li> </ul>
	<ul style="list-style-type: none"> <li>Outlet temperature has exceeded limit temperature.</li> <li>Alert: 63, 67, 79, 137, 276-281, 303-309</li> <li>LCI OFF</li> </ul>	<ul style="list-style-type: none"> <li>Verify that the system is full of water and that all air has been properly purged from the system</li> <li>Verify that the boiler is piped properly.</li> <li>Verify that adequate power is supplied to pump on a call for heat. If voltage cannot be detected check wiring</li> <li>Verify pump is circulating when power is supplied. If so, pump impeller may be stuck.</li> <li>If power is present during a call for heat, but the pump still does not circulate, replace the pump.</li> <li>Replace the DynaFlame Controller, if necessary.</li> </ul>
<b>Sensor Not Connected</b>	<ul style="list-style-type: none"> <li>Inlet sensor, Alert: 91</li> <li>Outlet sensor, Alert: 92</li> <li>DHW sensor, Alert: 93</li> <li>Flue sensor, Alert: 95</li> <li>Outdoor sensor, Alert: 96</li> </ul>	<ul style="list-style-type: none"> <li>Verify sensors are connected</li> <li>Verify wiring.</li> <li>Measure resistance of sensors, 10kΩ sensors.</li> <li>Replace sensor if necessary</li> </ul>
<b>Fan Not Turning</b>	<ul style="list-style-type: none"> <li>Fan refuses to rotate</li> <li>Alert 122, 123, 128, 129, 130, 131, 132</li> </ul>	<ul style="list-style-type: none"> <li>Check fan power wires</li> <li>Fan signal wires are interchanged</li> <li>Minimum fan speed must be greater than 1600 RPM</li> </ul>
<b>Air Proving Switch</b>	<ul style="list-style-type: none"> <li>Air Switch error</li> <li>Alert: 67, 137, 303-310</li> <li>ILK OFF</li> <li>IAS OFF</li> </ul>	<ul style="list-style-type: none"> <li>Air Switch wire(s) is/are loose</li> <li>Air Switch is set too tight, reduce sensitivity by turning screw ¼ turn counter-clockwise.</li> </ul>
<b>Blocked Flue Switch</b>	<ul style="list-style-type: none"> <li>LCI error</li> <li>Alert: 63, 137, 276-281</li> <li>LCI OFF</li> </ul>	<ul style="list-style-type: none"> <li>Blocked Flue Switch wire(s) is/are loose</li> <li>Blocked Flue Switch is set too tight, reduce sensitivity by turning screw ¼ turn clockwise.</li> </ul>

SYMPTOM	FAILURE MODE	ANALYSIS
<b>Flame Detection is out of Sync</b>	<ul style="list-style-type: none"> <li>Flame detection is present when no visible signs of a flame exist</li> <li>Lockout: 105, 158</li> </ul>	<ul style="list-style-type: none"> <li>Verify supply voltage for proper polarity.</li> <li>Check external wiring for voltage feedback</li> <li>Check internal wiring for proper connections</li> <li>Check the flame sensor and verify that it is clean</li> <li>Replace DynaFlame Controller, if necessary</li> </ul>
<b>Blank Display Screen</b>	<ul style="list-style-type: none"> <li>Blank display screen</li> </ul>	<ul style="list-style-type: none"> <li>Check wire connections from DynaFlame Controller to touchscreen display</li> </ul>
<b>Internal Fault</b>	<ul style="list-style-type: none"> <li>Lockout: 3-46, 58-60, 97-99, 143-148</li> </ul>	<ul style="list-style-type: none"> <li>Reset SOLA,</li> <li>If fault persists, replace SOLA</li> </ul>

**Table 17: Lockout codes**

#	Description
1	Unconfigured safety data
2	Waiting for safety data verification
3-46	Internal Fault. Replace SOLA Controller
47	Flame rod to ground leakage
48	Static Flame
49	24VAC low/high
50	Modulation Fault
64	Fan speed not proved, ignition failure
67	Interlock Off, safety circuit is open
79	Heater Outlet high limit tripped
81	Delta T Limit
82	Stack limit tripped (PVC: 149°F, CPVC: 194°F, 250°F)
91	Inlet sensor fault
92	Outlet sensor fault
93	DHW sensor fault
94	Header sensor fault
95	Stack sensor fault
96	Outdoor sensor fault
105	Flame detected out of sequence
106	Flame lost if Main Flame Establishing Period (MFEP)
107	Flame lost early in run
108	Flame lost in run
109, 110	Ignition failed
112	Pilot test flame timeout
113	Flame circuit timeout
149	Flame detected

\* If an internal hardware error is detected contact Camus® technical support for troubleshooting procedure.

**Table 18: Alert/Hold Codes**

#	Description
29	Burner switch turned OFF
30	Burner switch turned ON
47	Invalid subsystem reset request occurred
50	Modulation Fault (DR300 – 1000 ONLY)
61	Anti-short Cycle
62	Fan speed not proved
63	LCI off, safety circuit is open
68	Setpoint was overridden due to sensor fault
69	Modulation was overridden due to sensor fault
123	Modulation rate was limited due to outlet limit
124	Modulation rate was limited due to Delta-T limit
215	No Lead Lag slaves available to service demand
219	Using backup Lead Lag header sensor due to sensor failure
229	Lead lag slave communication timeout.
275-281	LCI off, safety circuit is open
283	Demand off during measured purge time
291	Abnormal Recycle: Flame was not on at end of Ignition period
292	Abnormal Recycle: Flame was lost during Main Flame Establishing Period
293	Abnormal Recycle: Flame was lost early in Run
294	Abnormal Recycle: Flame was lost during Run
303-310+	Interlock Off, safety circuit is open
324, 374-379	Hardware flame bias. Flame sensor wire needs to be re-routed.
352+	Stack sensor fault
355+	Outlet sensor fault
357+	DHW sensor fault
359+	Inlet sensor fault
460	LCI lost in run
550	Delta T inlet/outlet limit was exceeded

\* If an internal fault is detected contact Camus® technical support for troubleshooting procedure.

Alert 291: Abnormal Recycle: Flame was not on at end of ignition  
 Alert 294: Abnormal Recycle: Flame was lost during Run  
 Alert 324: Abnormal Recycle: Hardware flame bias  
 Alert 377: Abnormal Recycle: Hardware flame bias delta

This error occurs when a flame signal is not detected by the flame sensor. A minimum signal of 0.8Vdc must be detected by the flame sensor to prove the flame.

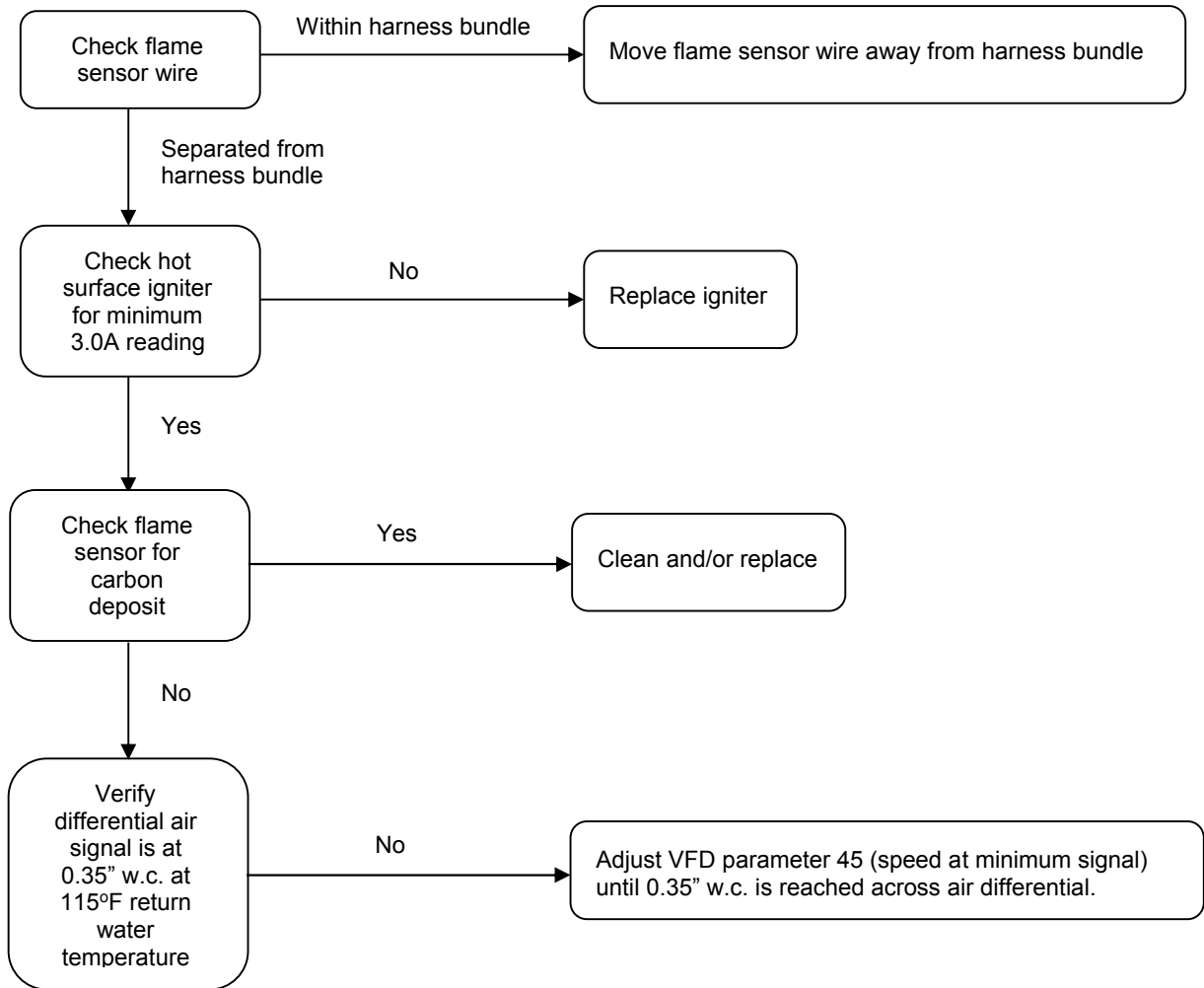

- Hold 63: LCI OFF (Load Control Input)**
- Hold 67: ILK OFF (High Limit, Gas Pressure Switch, Air Switch)**
- Alert 303: Abnormal Recycle: ILK off during drive to Purge**
- Alert 304: Abnormal Recycle: ILK off during Measured purge time**
- Alert 305: Abnormal Recycle: ILK off during Drive to Pre-ignition**
- Alert 306, 307: Abnormal Recycle: ILK off during Pre-ignition**
- Alert 308: Abnormal Recycle: ILK off during Main Flame**
- Alert 309: Abnormal Recycle: ILK off during Ignition Period**
- Alert 460: LCI lost in run**

This error occurs when one or more of the boiler safety switches are in an open condition when it is to be in a closed condition before the ignition sequence is allowed to proceed.

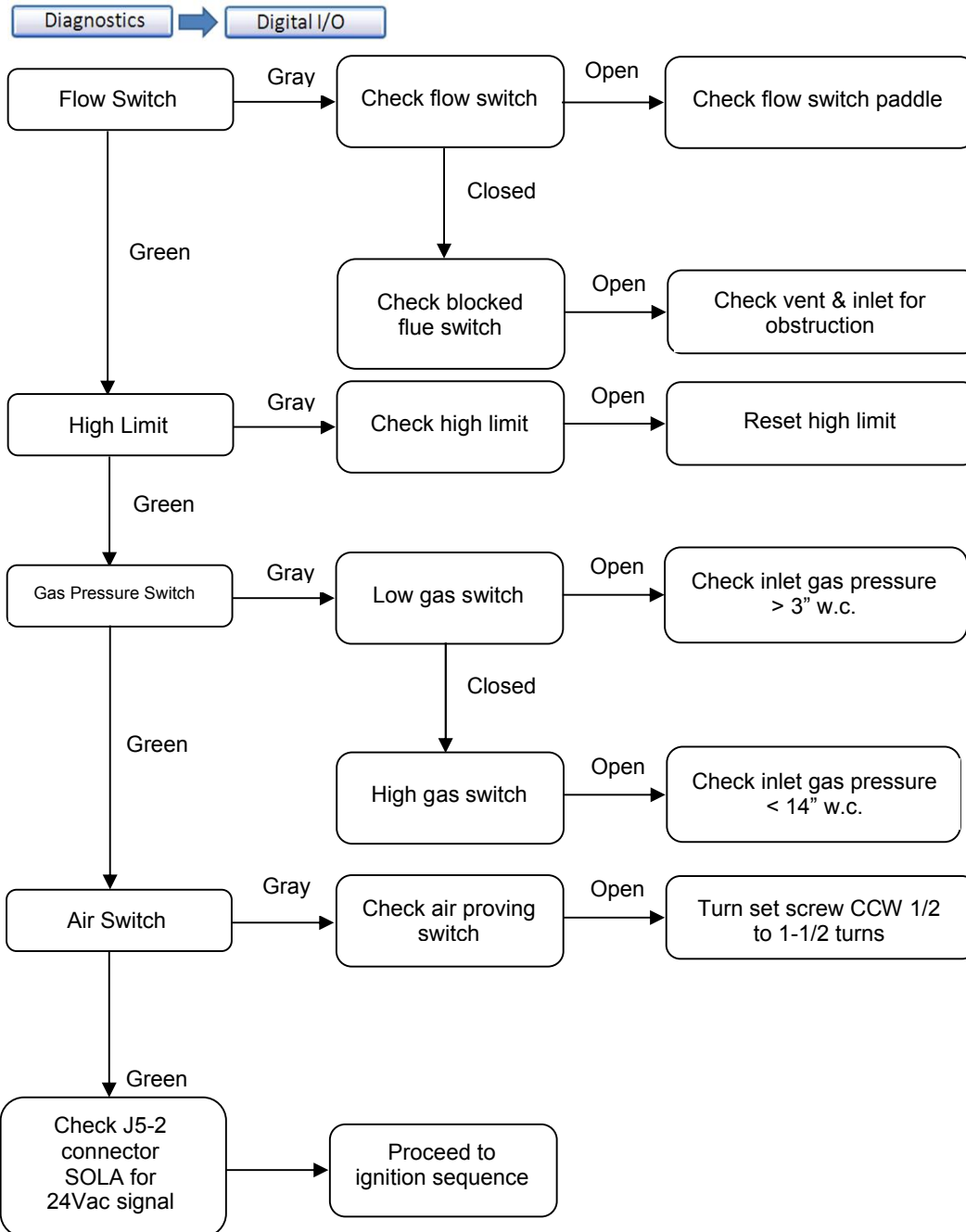

**Alert 354: Abnormal Recycle Delta-T limit**

This safety was breached as the inlet and outlet temperature difference exceeded 40°F. This is done to prevent damage to the heat exchanger. Before this error appears, the combustion air blower will slow down in an effort to prevent such an error from occurring.

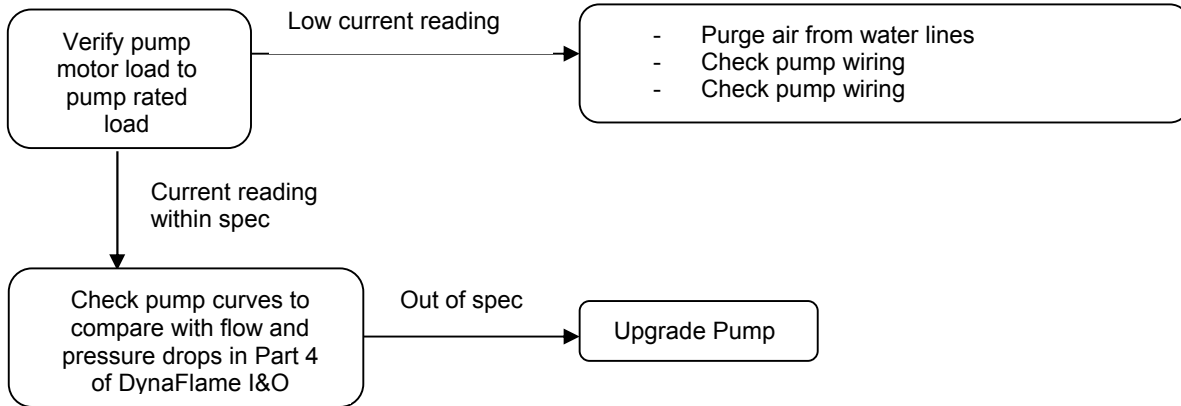

## PART 10 MAINTENANCE

### CAUTION

It is important that all gas appliances to be serviced by a Camus® trained service technician. It is in your own interest and that of safety to ensure that all local codes, and all the “NOTES” and “WARNINGS” in this manual are complied with. To service or adjust this appliance, it is imperative that the Camus® trained service technician utilize a combustion analyzer to read CO<sub>2</sub>, CO and flue pressure according to Camus® Hydronics recommendation

### CAUTION

Label all wires prior to disconnection when servicing controls. Wiring errors can cause improper and dangerous operation

Listed below are items that must be checked to ensure safe reliable operations. Verify proper operation after servicing.

### 10.1 EXAMINE THE VENTING SYSTEM

Examine the venting system at least once a year. Check more often in the first year to determine inspection interval. Check all joints and pipe connections for tightness, corrosion or deterioration. Flush the condensate drain hose with water to clean. Clean screens in the venting air intake system as required. Have the entire system, including the venting system, periodically inspected by a qualified service agency.

### 10.2 VISUALLY CHECK MAIN BURNER FLAMES

At each start up after long shutdown periods or at least every six months. A burner view port is located on the burner mounting flange.

### CAUTION

The area around the burner view port is hot and direct contact could result in burns

### NOTE

Check torque on fan mounting nuts using a torque wrench. Evenly tighten the nuts to 20 ft-lbs. Carefully examine the area adjacent to the fan flange for signs of overheating which are an indication that gaskets are in need of replacement

Figure 38: Normal Burner Flame Profile (short dense and blue)

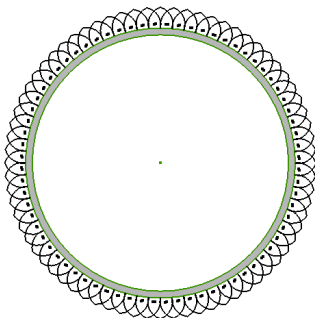

- Normal Flame: A normal flame at 100% of burner input is blue, with slight yellow tips a well defined flame and no flame lifting.
- Yellow Tip: Yellow tipping can be caused by blockage or partial obstruction of air flow to the burner.
- Yellow Flames: Yellow flames can be caused by

blockage of primary air flow to the burner or excessive gas input. This condition **MUST** be corrected immediately.

- Lifting Flames: Lifting flames can be caused by over firing the burner, excessive primary air or high draft in excess of negative 0.15" W.C.

If improper flame is observed, examine the venting system; ensure proper gas supply and adequate supply of combustion and ventilation air.

### 10.3 FLUE GAS PASSAGEWAYS CLEANING PROCEDURES

Any sign of soot around the inner jacket, outer jacket, flue pipe connections, burner or in the areas between the fins on the copper heat exchanger indicates a need for cleaning. The following cleaning procedure must only be performed by a qualified serviceman or installer. Proper service is required to maintain safe operation. Properly installed and adjusted units seldom need flue cleaning.

### NOTE:

All gaskets/sealant on disassembled components or jacket panels must be replaced with new gaskets/sealant on re-assembly. Gasket and sealant kits are available from the factory

### CAUTION

When the vent system is disconnected for any reason it must be reassembled and resealed according to vent manufacturer's instruction

### 10.4 CONDENSATION TREATMENT

This high efficiency appliance may operate as a condensing appliance for extended periods of time based on return water temperatures. Condensate occurs when the products of combustion are cooled below their dew point in the heat transfer process. The liquid condensate formed from this high efficiency heat transfer process is mildly acidic. The condensate will typically have a pH ranging from 4.0 to 5.0 as it is discharged from the condensate drain at the rear of the appliance. The internal jacket area where the condensate is collected (CHRM) is constructed from a special corrosion resistant stainless steel. All materials external to the appliance in contact with the condensate must be corrosion resistant. This is typically accomplished by using PVC or CPVC plastic pipe and synthetic tubing. Condensate must be able to flow freely from the appliance. All condensate flow is accomplished by gravity requiring a minimum downward slope of 1/4" per foot (21mm/m) to ensure proper flow to the condensate management system and/or a suitable drain. The neutralizer **MUST** always be mounted on the same level or lower than the bottom of the appliance cabinet and downstream of the condensate trap. All condensate piping and connections must be easily accessible for routine maintenance and inspection.

#### 10.4.1 CONDENSATE VOLUME

There are several factors affecting the amount of condensation created by the appliance CHRM, however for rough approximation use.

Condensation Volume, US Gallon/Hr = Input, MBH/1000 x



## 5.0

Many codes will require the acidic condensate to be neutralized before it can be placed in a drain system. A neutralizer to control the pH of the liquid discharged to a drain system is provided with every condensing appliance. The neutralizer consists of an industrial grade, non-corrosive plastic reservoir for collection of the condensate. The condensate collects in the reservoir where it is in direct contact with the calcium carbonate. As the reservoir fills, it provides an extended residence time to neutralize the condensate. The neutralized condensate exits from the reservoir outlet. A 'P' trap must be installed upstream of neutralizer see Figure 2 above. Prime the installed assembly with water to prevent flue gas spillage from the drain. Use standard ½" vinyl, PVC, CPVC or suitable hose to run to floor drain.

When the condensate level in the reservoir rises to the drain, the pH is controlled to a range of 5.5 to 6.0 before exiting the system. (A pH of 7 is neutral. As the pH number increases in numerical value, the relative acidity of the discharge decreases). The neutralized condensate may then be discharged into a suitable drain system without fear of damage to the drain system. Always check with local codes for specific requirements. Neutralizers may be used in series to raise pH. Neutralizer refills are available from Camus®.

### 10.5 BURNER MAINTENANCE

The burner should be removed for inspection and cleaning on an annual basis. An appliance installed in a dust or dirt contaminated environment will require inspection and cleaning on a more frequent schedule. The fan assisted combustion process may force airborne dust and dirt contaminants, contained in the combustion air, into the burner. With sustained operation, non-combustible contaminants may reduce burner port area, reduce burner input or cause non-warrantable damage to the burner.

Airborne contaminants such as dust, dirt, concrete dust or dry wall dust can be drawn into the burner with the combustion air and block the burner port area. An external combustion air filter is provided with the appliance. An additional filter is located at the fan inlet and like the external filter may be washed in the sink under the tap. This internal filter should be checked and cleaned at the time of appliance commissioning and on a six month interval or more often in a contaminated environment.

#### 10.5.1 BURNER REMOVAL AND CLEANING

Access to the burner will require the following steps:

- Turn off main electrical power to the appliance.
- Turn off main manual gas shutoff to the appliance
- Remove the top cover.
- Disconnect the gas supply connection to the fan inlet.
- Disconnect the fan motor power wires at the harness.
- Remove the hot surface igniter and the flame sensor.
- Remove the sensing tubes from the air ratio gas valve to the combustion air fan.
- Remove the 4 nuts holding the fan assembly to the heat exchanger and remove the fan assembly.

On occasion the red silicone gasket may adhere to the underside of the fan's flange. Carefully pry the flange away from the gasket prior to removing the fan assembly.

- The burner can now be lifted vertically out of the heat exchanger cavity. A ceramic paper gasket is located directly under the burner flange. This gasket must be replaced if it is damaged.
- Use care to prevent damage to the knitted metal fiber of the burner surface.
- Wash the burner with low pressure water. Never wipe or brush the surface of the burner nor use high pressure water or air.
- Check all gaskets and replace as necessary. Gaskets affected by heat will not reseal properly and must be replaced.
- Replace the burner in the reverse order that it was removed. Insert the igniter and sensor before doing the final tightening on the fan mounting nuts. Evenly tighten the nuts to 20 ft-lbs.

### NOTE:

When the combustion air fan is removed for any reason, the inlet to the burner must be covered to prevent further foreign objects from falling into the burner. Always look inside the burner to check for dents. Do not place a burner back into operation if the inner distribution screen has been dented during the service operation, call the factory for recommendations. Use care when removing and handling the burner, Sharp objects or impact may damage or tear the metal fiber surface rendering the burner unfit for service.

#### 10.5.2 BURNER CLEANING PROCEDURE

Remove any visible dust or dirt blockage from the surface of the burner using water from a garden hose. The burner may best be cleaned by immersing the burner port area in a solution of dishwashing detergent and hot water. Allow the burner to remain in the solution for a short period of time to remove dust, dirt and oil or grease laden contaminants. Rinse the burner thoroughly with clean water to remove any residue from the detergent cleaner. The burner should be air dried after removal from the cleaning solution and rinsing. **DO NOT** use chlorine based solvents or cleaning agents on the burner.

#### 10.6 CHANGING THE HOT SURFACE IGNITER

- The hot surface igniter is to be checked at least after every 4000 hours of operation and more frequently under high cycling conditions. This will maintain peak ignition efficiency.
- Turn off main electrical power to the appliance.
- Turn off main manual gas shutoff to the appliance.
- Locate the Hot Surface Igniter.
- Disconnect the two power leads to the hot surface igniter.
- Loosen and remove the two screws that hold the igniter.
- Lift the igniter vertically out of the burner mounting flange. Use care, do not hit or break the silicon carbide igniter. **DO NOT** pull out by leads.
- Ensure that the ceramic paper gaskets used to seal the base and top of the igniter are reinstalled on the new igniter.

### 10.6.1 RE-INSTALLING THE IGNITER

- Confirm that the end of the replacement igniter has a bead of silicone sealing the gap between the metal mounting flange and the ceramic shaft of the igniter.
- Carefully insert the igniter into the mounting point on the burner flange and push into position on top of the fan's flange.
- Reinstall the two mounting head screws and tighten by hand only.
- Ensure that the igniter ceramic paper gaskets are properly installed and seal the point of contact between the igniter and fan mounting flange.
- Reconnect the power leads to the igniter.
- Turn on main gas supply.
- Turn on main power.
- Test fire the appliance to ensure proper operation.
- The igniter must generate a minimum of 3A to reliably light the main burner (DF 500-2500) and pilot (models DF3000 – 6000).

### 10.7 PRIMARY HEAT EXCHANGER INSPECTION

- The primary heat exchanger should be inspected at the time of burner maintenance.
- Turn off all power to the appliance.
- Turn off main gas to the appliance.
- Remove top cover.
- Remove fan assembly and burner as detailed in the Burner and Cleaning section.
- Check the heat exchanger surface for soot. If soot is present, heat exchanger must be cleaned and problem corrected.
- Remove the front outer jacket door.
- Remove the front inner jacket door.
- Check "V" baffles on the exchanger.
- Use detergent water pressure wash to remove soot from heat exchanger and surfaces of the inner chamber.
- When necessary, the heat exchanger can be removed by disconnecting all water piping and removing the eight flange mounting bolts at the rear of the appliance. The heat exchanger can now be removed from the front of the appliance.
- Reinstall inner jacket door. Replace any damaged gaskets to ensure a proper air seal.
- Reinstall the burner and fan assembly.
- Reassemble all gas and water piping. Test for gas leaks.
- Reassemble outer jacket panels. Keep top cover off.
- Cycle unit and check for proper operation.
- Once proper operation is confirmed replace the top cover.

### 10.8 CONDENSING HEAT RECOVERY MODULE (CHRM) INSPECTION

- Inspect the CHRM annually.
- Turn off all power to the appliance.
- Turn off main gas to appliance.
- Remove the top cover, front and right side outer panels.
- Remove the CHRM access cover.
- Pressure wash the heat exchanger. Use a soft bristle brush to remove any remaining deposits. If necessary

the heat exchanger can be removed by disconnecting all water piping and lifting it out from the side.

### 10.9 RE-INSTALL HEAT EXCHANGERS

- Carefully reinstall the heat exchanger if removed from the appliance.
- Check all gaskets and replace if damaged.
- Replace heat exchanger cover.
- Reassemble outer jacket panels.
- Cycle unit and check for proper operation.
- Replace the top cover

### 10.10 COMBUSTION AIR FAN

Combustion air fan should be checked every 6 months. Clean internal filter to fan as required when installed in a dust or dirt contaminated location. See Combustion Air Fan in the component section for cleaning procedure. The motor and bearings on the combustion air fan are sealed and permanently lubricated requiring no addition of oil or lubricants.

### 10.11 COMBUSTION AND VENTILATION AIR

Check frequently to be sure that the flow of combustion and ventilation air to the appliance is not obstructed. Combustion and ventilation air must be provided to the mechanical room with openings sized per the requirements of the B149 or National Fuel Gas Code. The optional outdoor air kit brings combustion air from the outdoors directly to the appliance.

### 10.12 CONTROL CIRCUIT VOLTAGE

This appliance uses a transformer to supply a low voltage control circuit. The voltage on the secondary side should be 24 to 28VAC when measured with a voltmeter. A secondary voltage of 21VAC or less supplied to 24VAC components may cause operational problems. A 4A circuit breaker is provided on the secondary side of the transformer. The circuit breaker is located on the front control panel. A tripped circuit breaker indicates a short in the 24VAC controls and must be corrected.

### 10.13 COMBUSTIBLE MATERIALS

#### CAUTION

Keep appliance clear from combustible materials; do not store **GASOLINE** and other flammable vapors and liquids in the proximity of the appliance.

### 10.14 FREEZE PROTECTION

Installations are not recommended in areas where the danger of freezing exists. Proper freeze protection must be provided for appliances installed outdoors, in unheated mechanical rooms or where temperatures may drop to the freezing point or lower. If freeze protection is not provided for the system, a low ambient temperature alarm is recommended for the mechanical room. Damage to the appliance by freezing is non-warrantable.

- **Location** - Heating boilers, hot water supply boilers or water heaters must be located in a room having a temperature of at least 50°F (10°C)

- **Caution** - A mechanical room operating under a negative pressure may experience a downdraft in the flue of an appliance that is not firing. The cold outside air may be pulled down the flue and freeze a heat exchanger. This condition must be corrected to provide adequate freeze protection.
- Freeze protection for the appliance using an indirect coil can be provided by using hydronic system antifreeze. Follow the manufacturer's instructions. **DO NOT** use undiluted or automotive type antifreeze.
- **Shut-down and draining** - If for any reason, the unit is to be shut off in a space where danger of freezing exists, the following precautionary measures must be taken:
  - Shut off gas supply.
  - Shut off water supply.
  - Shut off electrical supply.
  - Drain the main exchanger and the secondary exchanger, if supplied, completely.
  - Ensure that the pump and connecting piping are fully drained.

### 10.15 FREEZE PROTECTION FOR A HEATING BOILER SYSTEM (Optional)

- Use only properly diluted inhibited glycol antifreeze designed for hydronic systems.
- Follow the instructions from the antifreeze manufacturer. Quantity of antifreeze required is based on total system volume including expansion tank volume.
- Antifreeze is denser than water and changes the viscosity of the system. The addition of antifreeze will decrease heat transfer and increase frictional loss in the boiler and related piping. Where antifreeze has been used, to maintain the temperature rise across the appliance confirm that the recommended GPM for pure water has been increased by 15% and the head loss by 20%.
- Local codes may require a back flow preventer or actual disconnect from city water supply when antifreeze is added to the system.
- When filling or topping-up the system with water mixed with the antifreeze always use distilled or RO (reverse osmosis) water. This will prevent the reaction of the water with antifreeze which can create sludge.

## PART 11 INSTALLATIONS

### 11.1 HEATING BOILER INSTALLATIONS

The appliance **MUST** always be installed in a **primary/secondary piping system for proper operation**. Before beginning the installation, consult local codes for specific plumbing requirements. The installation should provide unions and valves at the inlet and outlet of the appliance so it can be isolated for service. An air separation device must be supplied in the installation piping to eliminate trapped air in the system. Locate a system air vent at the highest point in the system. The system must also have a properly sized expansion tank installed. Typically, an air charged diaphragm-type expansion tank is used. The expansion tank must be installed close to the boiler and on the suction side of the system pump (appliance Inlet) to ensure proper operation. Caution: This appliance should not be operated at less than 15 PSIG cold. Pressure will rise when hot. Expansion tank sizing will determine the pressure when the system is hot. Do not operate the system at less than 30 PSIG when hot. Water piping must be supported by suitable hangers or floor stands, NOT by the appliance. Pipe systems will be subject to considerable expansion and contraction. Pipe supports could allow the pipe to slide resulting in noise transmitted into the system. Padding is recommended. The boiler pressure relief valve must be piped to a suitable floor drain. See Section 4.12.

#### CAUTION

- 1) A leak in a boiler "System" will cause the "System" to intake fresh water constantly, which may cause the tubes to accumulate a lime/scale build up. This will be a **NON-WARRANTABLE FAILURE**.
- 2) If boiler pumps are not operated when treated water is introduced, a corrosion cell may be created in the boilers leading to a failure which is not covered by warranty.
- 3) Target water quality of treated water to be stable and neutral with regards to corrosive/scaling properties. Damage to or failure of the heat exchanger as a result of scaling or corrosive water quality is not covered by warranty.

### 11.2 WATER CONNECTIONS

Copper and copper-nickel heat exchanger models have FIP inlet and outlet bronze connections. Stainless steel heat exchanger models have groove locked inlet and outlet stainless steel connections. Pipe size must be in accordance with Table 5 and, between supply and return lines, must not exceed 80 feet of equivalent length. Any reduction in recommended pipe size may decrease flow resulting in high water temperatures, boiler noise, flashing to steam and non-warrantable heat exchanger damage.

### 11.3 PIPING LENGTHS

The appliance circulator provides the water flow from the primary boiler piping, through the boiler and back to the primary system. Pipe diameter and length are critical to ensure proper flow through the boiler.

The secondary loop piping to and from the appliance must have a fully ported ball valve installed in both the supply and return side piping and will be used for isolation only. The ball valves must be the same diameter as the installed

pipng. If flow control is required, other means of flow control such as globe valve or flow setter should be used.

## 11.4 INTERMITTENT PUMP OPERATION

An intermittent pump operation signal is standard and can be used to operate a separate pump contactor. A 1 hp pump delay relay is available as an option. When equipped with this option, the boiler's integral circulating pump will cycle on at each call for heat, before the burner fires. The pump will continue to operate while the burner is firing. The pump will run for a post-pump period, after the temperature set point is satisfied. This will remove any residual heat from the combustion chamber before turning the pump off. See wiring diagram shipped with the unit.

## 11.5 SUMMARY

### a) Typical Boiler Installations

#### General Plumbing Rules

- 1 Check all local codes.
- 2 For serviceability of boiler, always install unions.
- 3 Always pipe pressure relief valve to an open drain.
- 4 Locate system air vents at highest point of system.
- 5 Expansion tank must be installed near the boiler and on the suction side of the system pump.
- 6 Support all water piping.

### b) Placing the Boiler in Operation

#### Pre-Start Check List

- 1 Review the location of the boiler, clearances from combustible surfaces and available service clearances.
- 2 Review Part 2 Venting. Ensure that all vent components are fabricated from the correct category of materials with adequate clearance from combustibles.
- 3 Ensure that the boiler condensate drain and all vent system condensate drains are properly routed to an acceptable floor drain or neutralization system.
- 4 Review the vent termination point for proper location and clearances.
- 5 Ensure that proper volumes of combustion and ventilation air are provided to the mechanical room. If a separate combustion air pipe is used, ensure that it is properly sized, sealed and terminated.
- 6 Review the water piping from the boiler to the system. The boiler must be installed in a primary/ secondary piping system. Review the diameter and equivalent length of the installed piping to and from the boiler to ensure proper flow.
- 7 Ensure that a properly sized primary system pump is installed with an expansion tank.
- 8 Check system pressure. Ensure a minimum of 30 PSIG with the system hot and not more than 90% of the rated pressure of the relief valve.
- 9 Review the installed gas piping from the meter to the boiler. Ensure that the gas pipe, meter and any regulators are adequately sized.
- 10 Review the field wiring and electrical service for both the boiler controls and pump. Ensure that the electrical service(s) is adequately sized.

### Boiler Set-Up

- 1 Ensure that the boiler and piping system are full of water. Bleed all air from the pump housing and secondary loop.
- 2 Check system for any water leaks.
- 3 Check system for installation of glycol or water treatment where required. Where glycol has been used to maintain the temperature rise across the appliance confirm that the recommended flow for pure water has been increased by 15% and the head loss by 20%.
- 4 Turn on power to the primary system pump and the appliance secondary pump and verify operation.

### Boiler Operational Checks

- 1 Turn the boiler main power switch to the "ON" position.
- 2 Verify operation of the Fuji and Diagnostic Display.
- 3 Program the adjustable points.
- 4 Turn the switch to the "ON" position to start boiler operation.
- 5 Push the resets for low water level, high water temperature and flame failure.
- 6 Install a manometer on the gas supply to the boiler and verify minimum gas supply pressure as the burner fires at 100% of rated input.
- 7 Verify operation of safeties as necessary (low water cut-off, high limit, gas pressure, etc.).

### Boiler Operation

- 1 Appliance should begin the start-up process for the sequence of operation.
- 2 The boiler will fire down to 20% for condensing and near-condensing appliances and 35% for non-condensing appliances on initial start-up and adjust input as required to meet system demand.
- 3 Ensure that inlet water temperature does not fall below 115°F (46°C) for non-condensing and 130°F (55°C) for condensing and near-condensing.
- 4 Based on system demand, the appliance will modulate accordingly.
- 5 As system demand is satisfied, the burner will cycle off and the combustion air fan will decelerate at a pre-programmed rate before the appliance shuts down.

## 11.6 DOMESTIC HOT WATER HEATER

Hot water heaters are designed for installation with a storage tank. The operation of the properly sized circulating pump, the piping between the tank and heater and the control of water velocity, as explained below, are important for correct operation of your hot water heater.

### 11.7 WATER VELOCITY CONTROL

To ensure proper velocity through the heat exchanger(s), it is necessary to select the proper pump. Temperature rise at full fire will be an indication of flow. This must be done on initial installation and periodically rechecked.

Excessive lime/scale build-up in the heat exchanger tubes is a result of restricted flow and too little velocity in the tubes. Excessive pitting or erosion in the tube is caused by high water flow and too much velocity through the tubes.

Care should be taken to maintain required water velocity based on water condition as follows:

### 11.8 TEMPERATURE RISE AT FULL FIRING RATE

- 1 The pump must run continuously when the burner is firing.
- 2 With the pump running and the burner in the water heater or hot water supply boiler in the off cycle, the Return/Inlet temperature and Supply/Outlet temperature readings on the display should read approximately the same temperatures.
- 3 Turn the hot water heater on and allow time for the temperature to stabilize. Check the temperature rise when the burner is firing at 100% of rated input.
- 4 Compare the temperature rise on the display with the required temperature rise at the required flow rate based on water condition (Soft, Normal, and Hard). Should adjustment be needed, proceed as follows:

***If the temperature rise is too high, the water velocity is too low. Adjust as follows:***

- 1 Check for flow restrictions. Check for debris in strainers
- 2 Check diameter and equivalent length of the piping between the storage tank and hot water heater.
- 3 Be sure all valves are open between the hot water heater and the storage tank. Ensure that all ball valves are fully ported.
- 4 Check the pump to be sure it is running properly and that the pump motor is running in the proper direction.
- 5 Be sure the pipes between the hot water heater and storage tank are not more than a total of 80 equivalent feet between supply and return lines. If maximum equivalent length for the specified pipe diameter is exceeded, larger diameter pipe may have to be installed to achieve correct flow and temperature rise.
- 6 Common manifold piping for multiple unit installations will require larger minimum pipe sizes and tank circulating tapping to ensure proper flow.

***If the temperature rise is too low, the water velocity is too high. Adjust as follows:***

- 1 Temperature rise can be increased by slowly closing the flow control valve (globe valve or flow setter) in the outlet piping from the hot water heater to the storage tank to achieve the proper temperature rise.
- 2 Sustained high water velocity and low temperature rise may result in pitting or erosion of the copper tubes in the heat exchangers. This is a non-warrantable failure. Temperature rise must be properly adjusted to achieve the specified flow rate.

The required temperature rise and the recommended pump size are based on the heating of potable water with normal hardness. For DHW applications with other than normal hardness, choose a pump for the local water hardness conditions. Alternatively, soften the water to normal levels. Damage to the heat exchanger as a result of scaling or corrosive water conditions is non-warrantable.

**CAUTION**

Temperature rise cannot be adjusted when the burner is firing at less than 100% of input rate.

### 11.9 WATER HEATERS

Incorrect piping of the cold water supply to the system may result in excessive low temperature operation causing condensate formation on the primary heat exchanger and operational problems. The cold water supply piping must be installed in the discharge piping from the heater to the storage tank. This allows the cold water to be tempered in the storage tank before entering the heater.

The manufacturer recommends the use of a properly sized thermostatic mixing valve to supply domestic hot water at temperatures less than 140°F (60°C). Storing the water at a higher temperature and thermostatically mixing the water will decrease the size of the storage tank and increase the available quantity of mixed hot water. Caution! Adequate care **MUST** be taken to prevent potential scald injury when storing water at 140°F (60°C) and hotter.

- Piping components connected to the water heater for a space heating application shall be suitable for use with potable water.
- Toxic chemicals, used for boiler treatment, shall not be introduced into the potable water used for space heating
- A water heater which will be used to supply potable water shall not be connected to any heating system or component(s) previously used with a non-potable water heating appliance
- When a system requires water for space heating at temperatures higher than required for other uses, a means such as a mixing valve shall be installed to temper the water for those uses in order to reduce scald hazard potential.

<b>CAUTION</b>
Adequate care <b>MUST</b> be taken to prevent potential scald injury when storing water at 140°F (60°C) and hotter.
<b>WARNING</b>
Should overheating occur or the gas supply fail to shut off, do not turn off or disconnect the electrical supply to the pump, instead, shut off the gas supply at a location external to the appliance.

# PART 12 EXPLODED VIEW

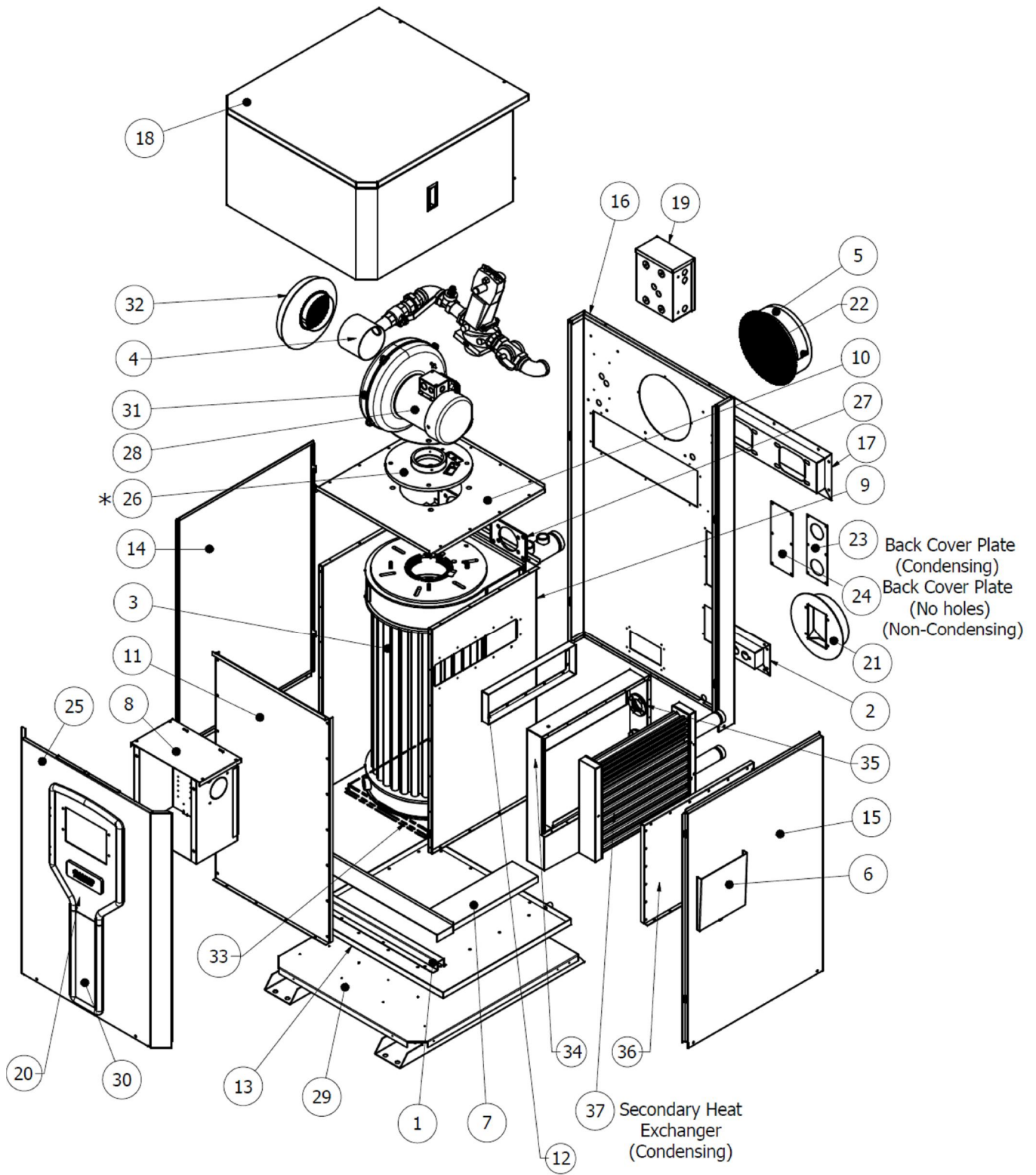

\* REFER TO NEXT PAGE FOR BURNER GASKET DETAIL

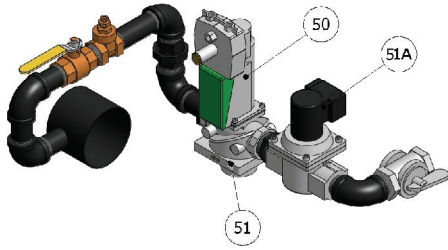
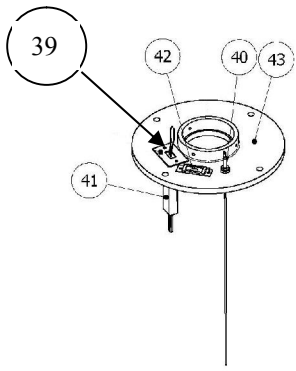

3

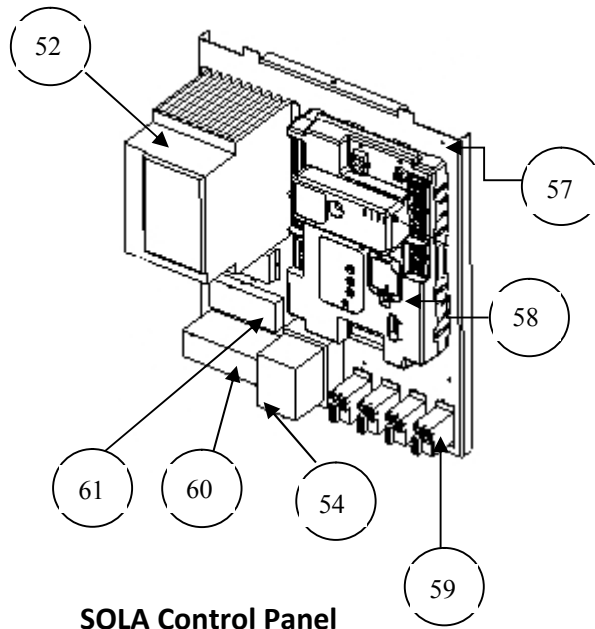

**SOLA Control Panel**

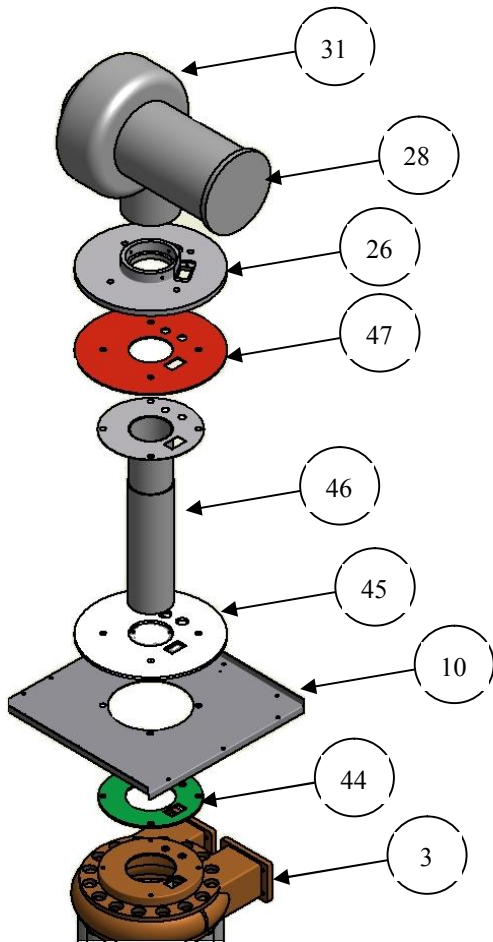

Ref #	Name of Part	Part ID	DynaFlame Model																
			ALL	500	750	1100	1200	1500	1750	2000	2500	3000	3500	4000	4500	5000	4504	5004	6004
1	Lip Protector	14-5214-11A		X															
		102752			X	X	X												
		102753						X											
		14-5214-30A							X	X	X	X							
		14-5214-35-50A											X	X	X	X			
		14-5315																X	X
2	Bottom Transition Inner to Outer Jacket	14-5235A		X	X	X	X	X	X	X	X	X	X	X	X	X			
		14-5328															X	X	X
3	Primary Copper/ Copper Nickel Heat Exchanger (V Baffles Included)	DF-500-HTX		X															
		DF-750-HTX			X														
		DF-1100-HTX				X													
		DF-1200-HTX					X												
		DF-1500-HTX						X											
		DF-1750-HTX							X										
		DF-2000-HTX								X									
		DF-2500-HTX									X								
		DF-3000-HTX										X							
		DF-3500-HTX											X						
		DF-4000-HTX												X					
		DF-4500-HTX													X				
		DF-5000-HTX														X			
		DF-4504-HTX															X		
		DF-5004-HTX																X	
		DF-6004-HTX																	



Ref #	Name of Part	Part ID	DynaFlame Model																	
			ALL	500	750	1100	1200	1500	1750	2000	2500	3000	3500	4000	4500	5000	4504	5004	6004	
3	Stainless Steel Primary Heat Exchanger (V Baffles Included)	109016		X																
		109017			X															
		109018				X	X													
		109020						X												
		109021							X											
		109022									X									
		109023										X								
		109025											X							
		109026												X						
		109028													X					
		109029														X				
		109030															X			
		109032																X		
		109033																	X	
		109034																		X
4	Fan/Air Gas Inlet Adapter	13-0026		X	X	X	X	X	X	X										
		66-5005										X								
		13-0027											X	X	X					
		66-5011													X	X	X	X	X	
5	Outside Air Intake Housing	DF-14-0119		X	X	X	X	X	X											
		DF-14-0120								X	X	X								
		DF-14-0121											X	X	X	X	X	X	X	
6	Literature Pocket	14-0150	X																	
7	Condensate Bin Shield Assembly	14-0315-A		X	X	X	X													
		14-0316A						X	X	X	X	X	X	X	X					
		14-0317A															X	X	X	

Ref #	Name of Part	Part ID	DynaFlame Model																
			ALL	500	750	1100	1200	1500	1750	2000	2500	3000	3500	4000	4500	5000	4504	5004	6004
8	Electrical Box	14-1030		X	X	X	X												
		14-1005						X	X	X	X	X	X	X	X	X	X	X	X
9	Combustion Chamber Wrap	14-5008		-05A	-07A	-11A	-11A												
		14-5202						-15A	-17A	-20A	-25A	-30A	-35A	-40A	-45A	-50A			
		14-5302																-45	-50
10	Combustion Top Panel	14-5009A		X	X	X	X												
		14-5203-15A-25A						X	X	X	X								
		102711										X							
		14-5203-35-50A											X	X	X	X			
		14-5303																X	X
11	Combustion Chamber Door	14-5010-05A		X															
		14-5008-07A			X														
		102631				X	X												
		14-5204							-15A	17A	20A	25A		35A	40A	45A	60A		
		102711											X						
		14-5302																	-45
12	Flue Duct	14-5014A		X	X	X	X												
		14-5208A						X	X	X	X	X	X	-35-50A					
		14-5308																X	X
13	Combustion Chamber Condensate Bin	14-5021A		X	X	X	X												
		14-5211						X	X	X	X	X	X	X	X				
		14-5311																X	X
14	Outer Jacket Left Panel	14-6011		-05A	-07A	-11A	-11A												
		14-5222						-15A	-17A	-20A	-25A	-30A	-35A	-40A	-45A	-50A			
		14-5322																	-45

Ref #	Name of Part	Part ID	DynaFlame Model																
			ALL	500	750	1100	1200	1500	1750	2000	2500	3000	3500	4000	4500	5000	4504	5004	6004
15	Outer Jacket Right Panel	14-6012		-05A	-07A	-11A	-11A												
		14-5223						-15A	-17A	-20A	-25A	-30A	-35A	-40A	-45A	-50A			
		14-5323															-45	-50	-60
16	Outer Jacket Rear Panel	14-6021		-05A	-07A	-11A	-11A												
		14-5224						-15A	-17A	-20A	-25A	-30A	-35A	-40A	-45A	-50A			
		14-5324															-45	-50	-60
17	Top Transition Inner to Outer Jackets	14-6025A		X	X	X	X												
		14-5225A						X	X	X	X	X	X	X	X	X			
		14-5325																X	X
18	Outer Jacket Top Cover Assembly	14-6030A		X	X	X	X												
		14-5228A						X	X	X	X	X							
		14-5228A-50											X	X	X	X			
		14-5329-45-50																X	X
		14-5329-60																	
19	Junction Box	14-5240A	X																
20	Display Bezel	90-10004	X																
21	Vent Transition Disk	14-5279	X																
22	Rear Filter	109265-10		X	X	X	X	X											
		109265-12							X	X	X	X							
		1092665-14											X	X	X	X	X	X	X
23	Back Cover Plate (Condensing)	14-6022A		X	X	X	X	X	X	X	X	X							
		14-5323A											X	X	X	X	X	X	
24	Back Cover Plate (Non-Condensing)	14-6023A		X	X	X	X	X	X	X	X	X							
		14-6023A-50											X	X	X	X	X	X	

Ref #	Name of Part	Part ID	DynaFlame Model																
			ALL	500	750	1100	1200	1500	1750	2000	2500	3000	3500	4000	4500	5000	4504	5004	6004
25	Outer Jacket Front Panel	14-6004		X	X	X	X												
		14-5221						X	X	X	X	X	X	X	X	X			
		14-5321																X	X
26	Fan Flange	13-5052		X	X	X	X												
		13-5330						X	X	X									
		13-5331									X	X							
		13-5332											X	X	X	X	X	X	
		13-5333																	
27	Inlet Outlet Header Rear Gasket	33-0013		X	X	X	X												
		33-0014						X	X	X	X	X	X	X	X	X			
		33-0030															X	X	X
28	Electrical Motor	1/2 HP		X	X	X	X												
		1 HP						X	X	X									
		1 1/2 HP									X	X							
		3 HP											X	X	X		X		
		5 HP														X		X	X
29	Base Panel	14-5012A		X	X	X	X												
		14-5206A						X	X	X	X	X	X	X	X	X			
		14-5306															X	X	X
30	Lower Finishing Bezel	90-10012		X															
		90-10020			X			X											
		90-10010				X	X		X	X									
		90-10006									X						X		
		90-10005										X	X					X	
		90-10007												X	X	X			

Ref #	Name of Part	Part ID	DynaFlame Model																
			ALL	500	750	1100	1200	1500	1750	2000	2500	3000	3500	4000	4500	5000	4504	5004	6004
31	Fan Housing	AF9		X	X	X	X	X	X	X									
		AF10										X	X						
		AF12												X	X	X	X	X	X
		AF15																	
32	Filter Holder	DF-14-0119		X	X	X	X	X	X										
		DF-14-0120									X	X	X						
		DF-14-0121												X	X	X	X	X	X
33	Heat Exchanger Base Support	14-5022A		X	X	X	X												
		14-5205A						X	X	X	X	X	X	X	X	X			
		14-5305																X	X
34	Flue Assembly (Non-Condensing)	14-5290		-05A	-11A	-11A	-11A	-17A	-17A	-30A	-30A	-30A	-35-50A				-500A	-600A	
	Flue Assembly (Non-Condensing)	14-5270		-05A	-11A	-11A	-11A	-17A	-17A	-30A	-30A	-30A	-35-50A				-500A	-600A	
35	Interior Seal Plate (2 req'd)	14-5269-B-R02	X																
	Exterior Seal plate (2 req'd)	14-5269-B-2-R01	X																
	CHRM Silicone Gasket	33-5210-B	X																
36	Secondary Heat Exchanger Cover	14-5270		-05A	-11A	-11A	-11A	-17A	-17A	-30A	-30A	-30A	-35-50A	-35-50A	-35-50A	-35-50A	-50A	-50A	-60A
37	Secondary Heat Exchanger	CAM 500		X															
		CAM 1750			X	X	X	X	X										
		CAM 3000									X	X	X						
		CAM 5000												X	X	X	X	X	X
		CAM 6000																	
39	Igniter Mounting Flange	14-5051-05-11	X																

Ref #	Name of Part	Part ID	DynaFlame Model																	
			ALL	500	750	1100	1200	1500	1750	2000	2500	3000	3500	4000	4500	5000	4504	5004	6004	
40	Flame Rod	<b>PSE-CH5</b>	X																	
41	Hot Surface Igniter	<b>271R</b>	X																	
42	View Port Glass	TG-94010-040	X																	
43	Vee Baffle Sets	14-0350		X																
		14-0351			X															
		14-0352				X	X													
		14-0354							-15A	-17A	-20A	-25A	-30A	-35A	-40A	-45A	-50A			
		14-0353																-45	-50	-60
44	Inlet Outlet Header Top Gasket	33-5239		X	X	X	X													
		33-5237						X	X	X	X									
		33-5238										X	X	X	X	X				
		33-5240																X	X	X
45	White Ceramic Gasket (Under Burner Flange)	33-5242		X	X	X	X													
		33-5241						X	X	X	X									
		33-5243										X	X	X	X	X				
		33-5245																X	X	X
46	Main Burner	66-5015-800		X																
		66-5015-750			X															
		66-5015-1400				X	X													
		DF-1500-BRN						X												
		DF-1750-BRN							X											
		DF-2000-BRN								X										
		DF-2500-BRN									X									
		DF-3000-BRN										X								
		DF-3500-BRN											X							
		DF-4000-BRN												X						
		DF-4500-BRN													X					
		DF-5000-BRN														X				
		DF-4504-BRN															X			
		DF-5004-BRN																X		
		DF-6004-BRN																	X	

Ref #	Name of Part	Part ID	DynaFlame Model																
			ALL	500	750	1100	1200	1500	1750	2000	2500	3000	3500	4000	4500	5000	4504	5004	6004
47	Burner Flange Red Silicone Gasket	33-5218		X	X	X	X												
		33-5224						X	X	X	X								
		33-5227										X	X	X	X	X			
		33-5230															X	X	X
50	Valve Actuator	V8730C1015		X															
		V8730C1023			X														
		V8730C1031				X	X												
		V4734C1002						X	X										
		SKP55								X	X	X	X	X	X	X	X	X	X
51	Valve Body	VGG10.404U								X	X	X	X	X	X	X			
		VGD40.065U															X	X	
		VGD40.080U																	X
51A	Solenoid Valve	V4295A1049								X									
		V4295A1056									X	X							
	Regulator Valve	SKP25										X	X	X	X	X	X	X	
52	Variable Frequency Drive (Standard)	ESV371N01SXB		X	X	X	X												
		ESV751N01SXB						X	X	X									
		ESV112N01SXB									X								
		ESV222N02YXB										X	X	X	X		X		
		ESV402N02TXB														X		X	X
	Variable Frequency Drive (Optional, 460V/60/3)	ESV371N04TXB		X	X	X	X												
		ESV751N04TXB						X	X	X									
		ESV112N04TXB									X								
		ESV222N04TXB										X	X	X	X		X		
		ESV402N04TXB														X		X	X

Ref #	Name of Part	Part ID	DynaFlame Model																
			ALL	500	750	1100	1200	1500	1750	2000	2500	3000	3500	4000	4500	5000	4504	5004	6004
53	On/Off Switch	ESWR4ABLKBLKAF0	X																
54	75VA Transformer	HCT-01J2BB07	X																
55	Blocked Flue Switch	<b>8021205256</b>	X																
56	Differential Pressure Switch	<b>NS2-1427-00</b>	X																
57	Control Box Plate	14-1005-03	X																
58	Honeywell SOLA	R7910A1001	X																
59	Relay(s)	1649341-8	X																
60	0-10Vdc Converter	ETISO-V	X																
61	24V Contactor	T92P7A22-24	X																
62	Touchscreen Display	S7999D1016	X																
	Not shown in exploded view																		
<b>Part</b>	Recommended spare parts																		





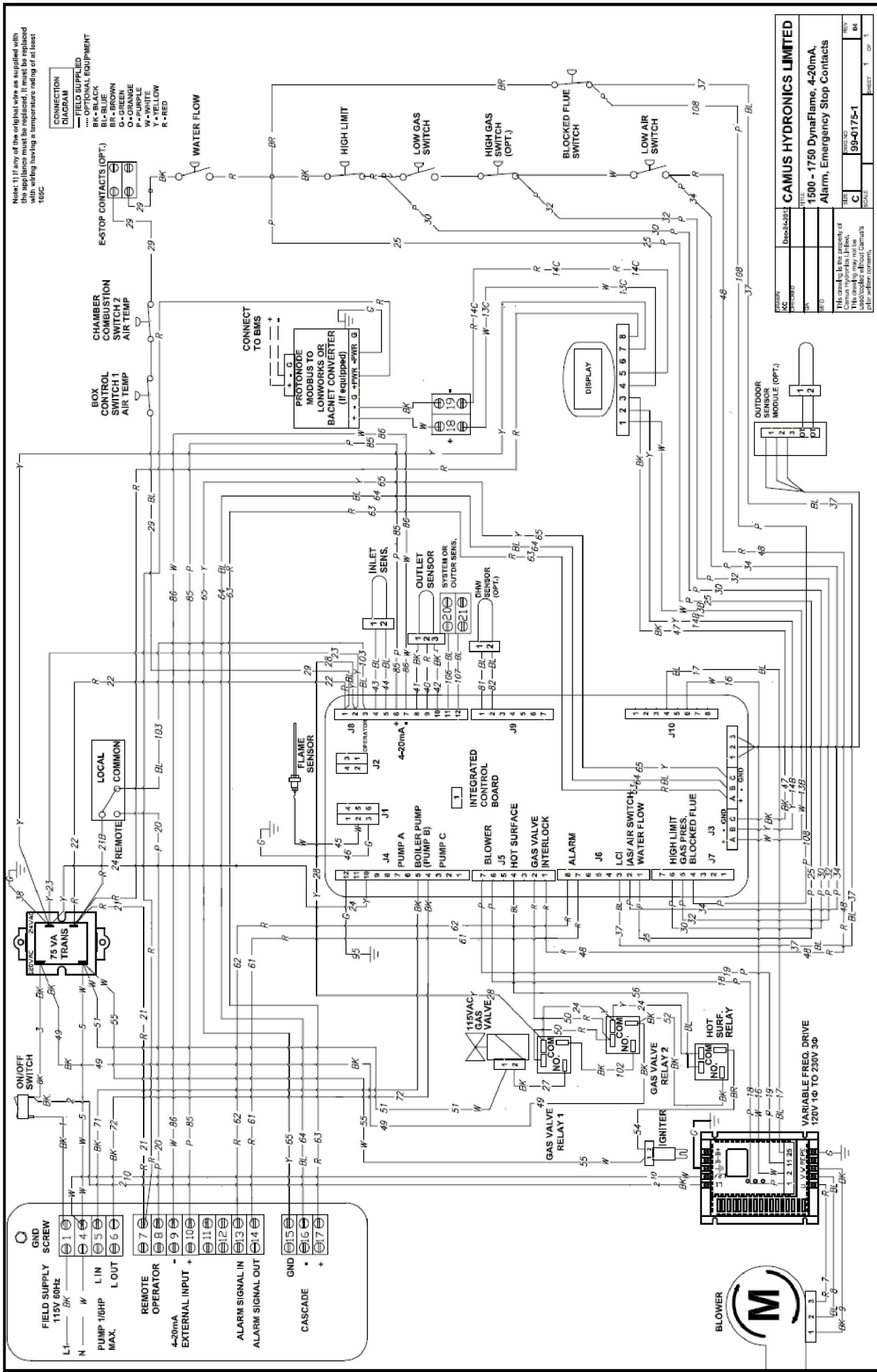

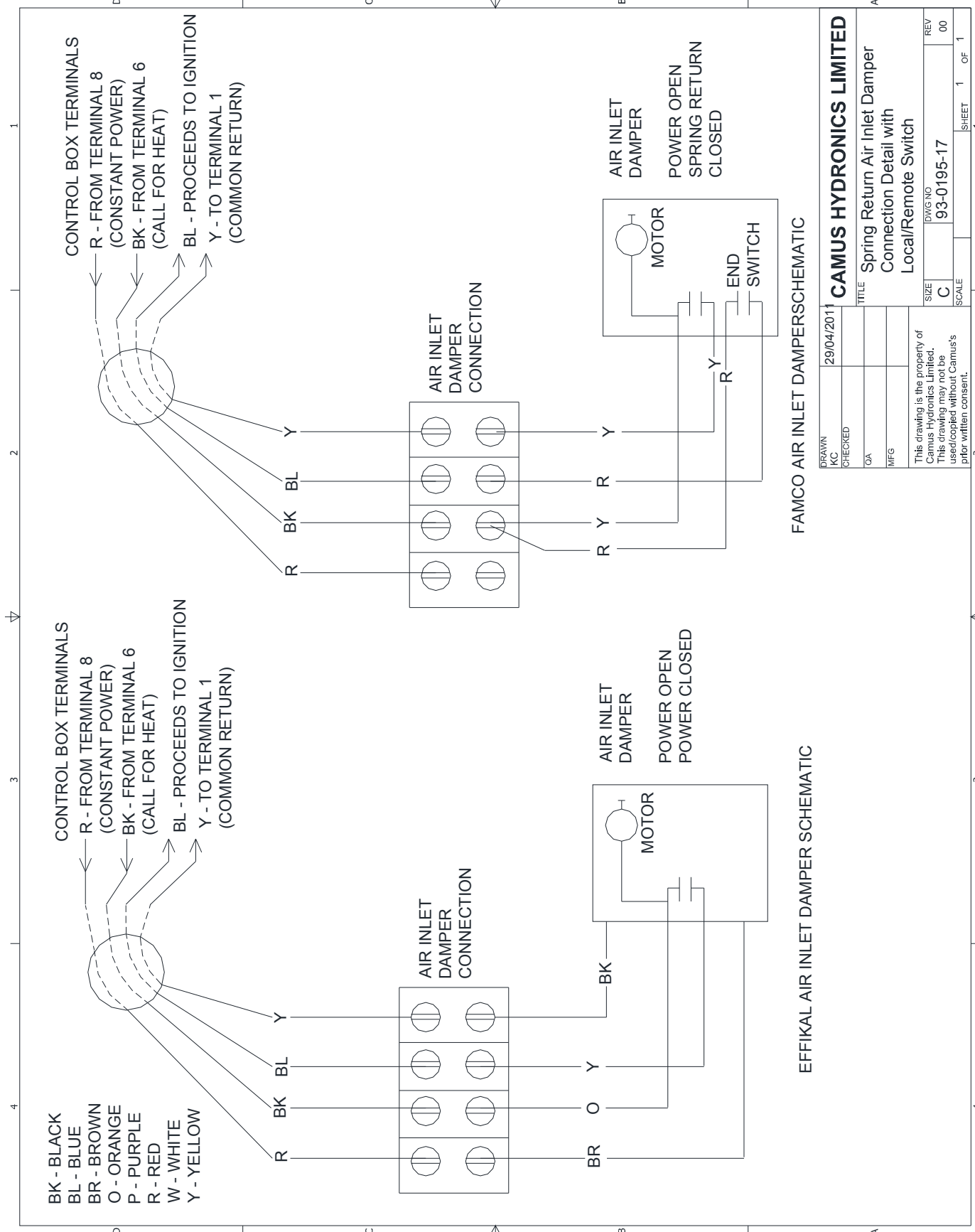

DRAWN	29/04/2011	<b>CAMUS HYDRONICS LIMITED</b>	
KC		TITLE	
CHECKED		Spring Return Air Inlet Damper	
QA		Connection Detail with	
MFG		Local/Remote Switch	
This drawing is the property of Camus Hydraulics Limited. This drawing may not be used/copied without Camus's prior written consent.		SIZE	REV
		C	00
		DWG NO	OF 1
		93-0195-17	1
		SCALE	SHEET
			1

FAMCO AIR INLET DAMPER SCHEMATIC

EFFIKAL AIR INLET DAMPER SCHEMATIC

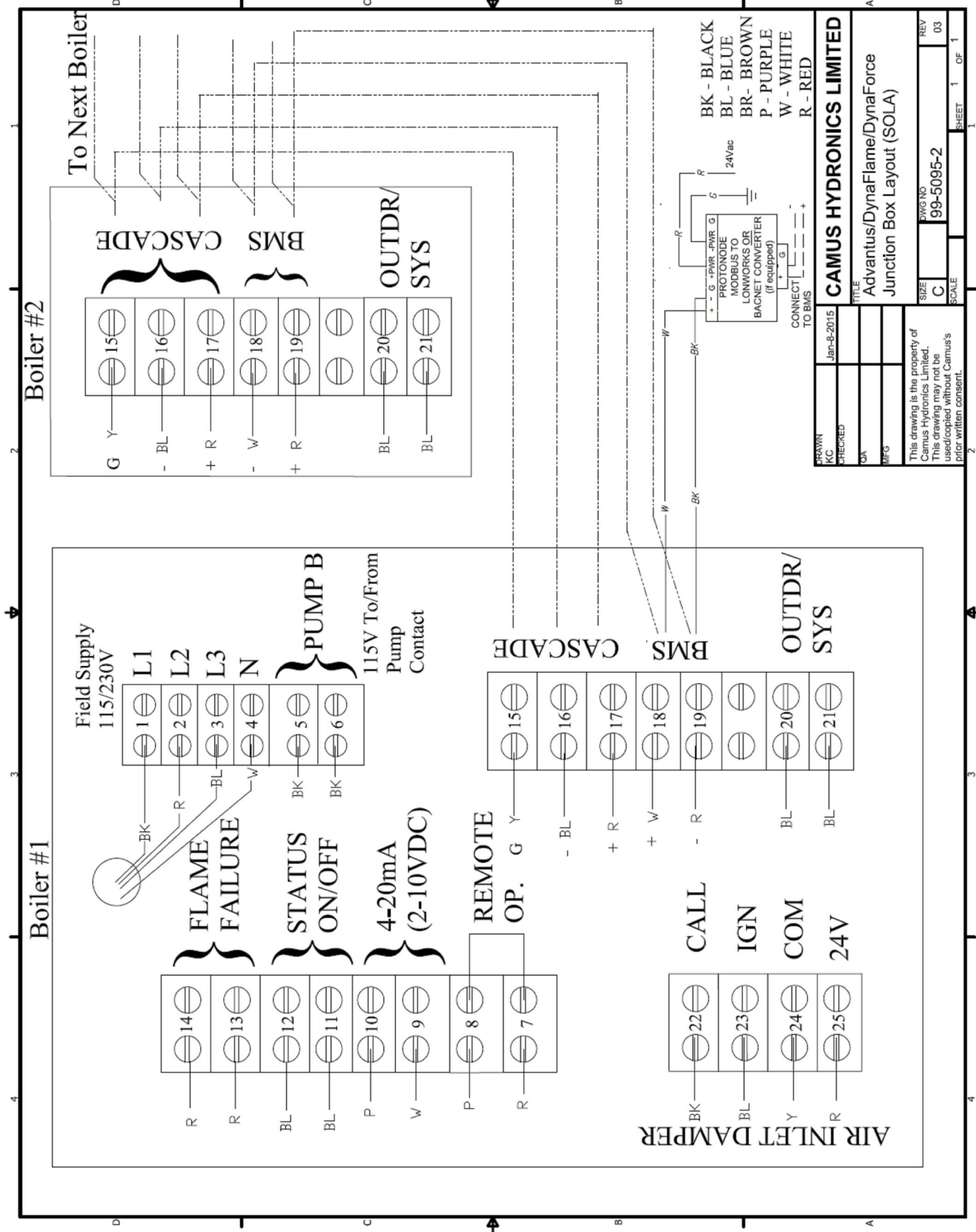

DATE	Jan-8-2015
TITLE	CAMUS HYDRONICS LIMITED
PROJECT	Advantus/DynaFlame/DynaForce
DESCRIPTION	Junction Box Layout (SOLA)
SCALE	1 OF 1
REV	03
SIZE	99-5095-2
SCALE	1 OF 1

This drawing is the property of Camus Hydronics Limited. This drawing may not be used/copied without Camus's prior written consent.

# WARRANTY

## GENERAL

Camus® Hydronics Limited (“Camus®”) extends the following LIMITED WARRANTY to the owner of this appliance, provided that the product has been installed and operated in accordance with the Installation Manual provided with the equipment. Camus® will furnish a replacement for, or at Camus® option repair, any part that within the period specified below, shall fail in normal use and service at its original installation location due to any defect in workmanship, material or design. The repaired or replacement part will be warranted for only the unexpired portion of the original warranty. This warranty does not cover failures or malfunctions resulting from: (1) Failure to properly install, operate or maintain the equipment in accordance with Camus®’ manual; (2) Abuse, alteration, accident, fire, flood, foundation problems and the like; (3) Sediment or lime build-up, freezing, or other conditions causing inadequate water circulation; (4) Pitting and erosion caused by high water velocity; (5) Failure of connected systems devices, such as pump or controller; (6) Use of non-factory authorized accessories or other components in conjunction with the system; (7) failing to eliminate air from, or replenish water in, the connected water system; (8) Chemical contamination of combustion air or use of chemical additives to water.

## HEAT EXCHANGER

Within 10 years of the appliance having declared FOB from Camus®, heat exchanger shall prove upon examination by Camus® to be defective in material or workmanship, Camus® will exchange or repair such part or portion based on the following pro-rated limited warranty: Percentage shown is the amount that would be covered by Camus® Hydronics Limited if deemed warranty based on the number of years the appliance has been in service.

Years In Service	DynaFlame® (STAINLESS STEEL)	DynaFlame® Heating (COPPER/CU-NI HTX)	DynaFlame® DHW (COPPER/CU-NI HTX)	DF Cond. Secondary HTX
1	100%	100%	100%	100%
2	100%	100%	100%	100%
3	100%	100%	100%	100%
4	100%	100%	100%	100%
5	100%	100%	100%	100%
6	100%	40%		
7	100%	35%		
8	100%	30%		
9	100%	25%		
10	100%	20%		

The exchanged or repaired heat exchanger will carry the balance remaining of the original warranty provided with the appliance based on the FOB date. In the event a replacement heat exchanger is delivered and if the defective heat exchanger is deemed to be repairable by Camus® the repaired heat exchanger will be returned to the customer and a credit will not be issued.

**Copper/Cu-Ni Heat Exchanger** – Heat exchanger shall be warranted for (20) years of the appliance having declared FOB from Camus® against “Thermal Shock” (excluded, however, if caused by appliance operation at large changes exceeding 150 °F between the water temperature at intake and appliance temperature, or operating at appliance temperatures exceeding 230 °F).

**Stainless Steel Heat Exchanger** – Heat exchanger shall be warranted for (20) years of the appliance having declared FOB from Camus® “Thermal Shock” (excluded, however, if caused by appliance operation at large changes exceeding 150 °F between the water temperature at intake and appliance temperature, or operating at appliance temperatures exceeding 210 °F).

## BURNER

If within FIVE years of the appliance having declared FOB from Camus® a burner shall prove upon examination by Camus® to be defective in material or workmanship, Camus® will exchange or repair such part or portion.

## ANY OTHER PART

If any other part fails within one (1) year, or eighteen (18) months of the appliance having declared FOB from Camus®, whichever comes first Camus® will furnish a replacement or repair that part. Replacement parts will be shipped f.o.b. our factory.

## HOW TO MAKE A CLAIM

Any claim under this warranty shall be made directly to Camus® Hydronics Limited Canadian Head Office

## SERVICE LABOR RESPONSIBILITY

Camus® shall not be responsible for any labour expenses to service, repair or replace the components supplied. Such costs are the responsibility of the owner.

**DISCLAIMERS**

Camus® shall not be responsible for any water damage. Provisions should be made that in the event of a water/appliance or fitting leak, the resulting flow of water will not cause damage to its surroundings.

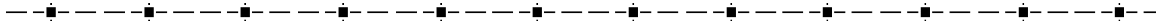

Name of Owner \_\_\_\_\_ Name of Dealer \_\_\_\_\_

Address \_\_\_\_\_ Address \_\_\_\_\_

Model No. \_\_\_\_\_ Serial No. \_\_\_\_\_

Date of Installation: \_\_\_\_\_ Date of Initial Operation: \_\_\_\_\_

[6226 Netherhart Road, Mississauga, Ontario, L5T 1B7, CANADA](#)

**CAMUS® Hydronics is a manufacturer of replacement parts for most copper finned**

**water heaters and heating boilers as well as a**

**supplier of specialty HVAC products. Our service line is open 24 hours, 7 days a week!**

**The CAMUS® CERTIFIED! Seal assures you that Reliability, Efficiency & serviceability are built**

**into every single unit! For more information**



**on our innovative products from CAMUS® Hydronics Limited, call 905-696-7800 today.**



**CAMUS® HYDRONICS LTD.**

**6226 Netherhart Road, Mississauga, Ontario L5T 1B7**

**TEL: 905-696-7800 FAX: 905-696-8801**