

INSTALLATION OPERATION AND SERVICE MANUAL

Dynaforce® Series



**GAS FIRED COMMERCIAL CONDENSING STAINLESS
STEEL TUBE BOILERS**



HYDRONIC HEATING

*Models; DRH300, 350 400, 500, 600, 800, 1000, 1200,
1400, 1600, 1800, 2000, 2500, 3000, 3500, 4000, 4500,
5000*



HOT WATER HEATER

*Models; DRW300, 350 400, 500, 600, 800, 1000, 1200,
1400, 1600, 1800, 2000, 2500, 3000, 3500, 4000, 4500,
5000*



WARNING:

If the information in these instructions is not followed exactly, a fire or explosion may result causing property damage, personal injury or death

Do not store or use gasoline or other flammable vapours and liquids in the vicinity of this or any other appliance.

WHAT TO DO IF YOU SMELL GAS

- Do not try to light any appliance,
- Do not touch any electrical switch; do not use any phone in your building,
- Immediately call your gas supplier from a neighbour's phone. Follow the gas supplier's instructions,
- If you cannot reach your gas supplier, call the fire department.

Qualified installer, service agency or the gas supplier must perform installation and service.

To the Installer: After installation, these instructions must be given to the end user or left on or near the appliance.

To the End User: This booklet contains important information about this appliance. Retain for future reference.



6226 Netherhart Road, Mississauga, Ontario, L5T 1B7

99-0171
Rev. 0.6

Table of Contents

PART 1	GENERAL INFORMATION.....	1
1.1	INTRODUCTION.....	1
1.2	SPECIAL INSTRUCTIONS TO OWNER	1
1.3	CHECKING EQUIPMENT	1
1.4	HOW IT OPERATES (SEQUENCE OF OPERATION).....	1
1.4.1	HEAT TRANSFER PROCESS	2
1.4.2	END OF SEQUENCE.....	2
1.5	CODES.....	3
1.6	WARRANTY	3
1.7	REMOVAL OF EXISTING APPLIANCE	3
1.8	BOILER ROOM OPERATING CONDITION.....	4
1.9	CLEARANCE FROM COMBUSTIBLE MATERIAL	4
1.10	INSTALLATION PROCEDURE AND LOCATION OF UNIT	5
PART 2	VENTING	7
2.1	GENERAL VENTING GUIDE.....	7
2.1.1	CATEGORY II AND CATEGORY IV VENTING	7
2.1.2	VENTING GUIDELINES FOR CATEGORY II AND/OR IV VENTING.....	7
2.1.3	APPROVED VENTING MATERIALS	8
2.1.4	VENT TERMINATION CLEARANCES	8
2.1.5	INLET CAP FOR ROOFTOP TERMINATION.....	8
2.1.6	LOCATION OF A ROOFTOP AIR INLET AND VENT CAPS.....	9
2.1.7	AIR INLET DAMPER.....	9
2.1.8	MASONARY CHIMNEY INSULATIONS	9
2.1.9	VERTICAL VENTING TERMINATION	9
2.1.10	COMBINED COMBUSTION AIR INLET	9
2.1.11	DRAIN TEE.....	10
2.2	CONVENTIONAL VENTING (INDOOR) INSTALLATIONS.....	10
2.2.1	AIR REQUIRED FOR COMBUSTION AND VENTILATION	10
2.2.2	EXHAUST FANS.....	11
2.3	OUTDOOR VENTING.....	11
2.4	SIDEWALL VENTING	11
2.4.1	SIDEWALL VENT TERMINAL & SIDEWALL INTAKE AIR TERMINAL	11
2.4.2	LOCATION OF A SIDEWALL VENT TERMINATION	11
2.4.3	LOCATION OF A SIDEWALL AIR INLET TERMINAL	12
2.4.4	LENGTH OF AIR INLET PIPE	12
PART 3	GAS CONNECTION.....	12
3.1	GAS CONNECTION	12
3.2	GAS PIPING	13
3.3	INSTALL PIPING	13
3.4	AIR/GAS RATIO VALVE.....	13
3.5	DIFFERENTIAL AIR PRESSURE (DR2000 – DR5000)	14
3.6	GAS MANIFOLD DIFFERENTIAL PRESSURE ADJUSTMENT (DR2000 – DR5000)	14
3.7	CHECKING GAS SUPPLY PRESSURE.....	15
3.7.1	Regulated Gas Supply Pressures for Dynaforce® Boilers & Water Heaters	15
3.8	CHECKING DIFFERENTIAL AIR AND GAS PRESSURES (DR2000 – DR5000).....	15
3.9	GAS TRAIN AND CONTROLS.....	16
3.10	VENTING OF GAS VALVES AND PRESSURE SWITCHES	16
3.11	BURNER	16
PART 4	WATER CONNECTION.....	17
4.1	FREEZE PROTECTION	17

4.2	WARNING REGARDING CHILLED WATER AND HEATING COIL SYSTEMS.....	17
4.3	INLET AND OUTLET CONNECTIONS.....	18
4.4	MINIMUM PIPE SIZE REQUIREMENTS.....	18
4.5	HEAT EXCHANGER.....	18
4.6	LOW WATER TEMPERATURE SYSTEMS	18
4.7	INSTANTANEOUS WATER HEATER.....	18
4.8	WATER FLOW SWITCH	19
4.9	LOW WATER CUTOFF (If Equipped)	19
4.10	RELIEF VALVE	19
4.11	CIRCULATING PUMP SELECTION.....	19
4.11.1	CIRCULATING PUMP OPERATION OF HEAT EXCHANGER.....	19
4.12	ΔT HEAT EXCHANGER ALGORITHM.....	20
PART 5	ELECTRICAL & CONTROLS.....	20
5.1	ELECTRICAL CONECTIONS.....	20
5.2	VARIABLE FREQUENCY DRIVE (DR1200 – 5000)	21
5.3	DIFFERENTIAL AIR PRESSURE SWITCH	21
5.4	BLOCKED FLUE SWITCH	21
5.5	DIFFERENTIAL GAS AND LOW GAS PRESSURE SWITCHES	21
5.6	HIGH LIMIT	21
5.7	DYNAFORCE® SOLA	22
5.7.1	SERVICE PARTS.....	22
5.7.2	IGNITION MODULE LOCKOUT FUNCTIONS.....	22
5.8	DYNAFORCE® CONTROLLER.....	22
5.9	ERROR TABLE	22
PART 6	CONTROL PANEL	24
6.1	APPLIANCE TEMPERATURE CONTROLLER	24
6.2	CONFIGURE MENU.....	40
6.3	LEAD LAG SETUP UP TO 8 BOILERS	42
6.4	LEAD LAG SETUP FOR UP TO 12 APPLIANCES.....	43
6.5	LOCAL/REMOTE SWITCH	43
6.6	COMM. PORT 2 ACTIVATION.....	43
6.6	VARIABLE FREQUENCY DRIVE (DR1200 - 5000).....	44
6.7	FROST PROTECTION	44
PART 7	COMPONENTS	45
7.1	HOT SURFACE IGNITER (GLOW BAR).....	45
7.2	FLAME SENSOR	45
7.3	COMBUSTION AIR FAN.....	45
7.4	INNER JACKET	45
7.5	OUTER JACKET	45
7.6	VENTING TRANSITION	45
PART 8	FIELD STARTUP PROCEDURE	46
8.1	CHECKING THE INSTALLATION.....	46
8.2	CHECKING THE CONSTRUCTION	46
8.3	GAS VALVE ADJUSTMENT PROCEDURE.....	46
8.4	COMISSIONING APPLIANCE	48
PART 9	TROUBLESHOOTING.....	49
PART 10	MAINTANANCE	56
10.1	EXAMINE THE VENTING SYSTEM	56
10.2	VISUALLY CHECK MAIN BURNER FLAMES	56
10.3	FLUE GAS PASSAGEWAYS CLEANING PROCEDURES	56
10.4	CONDENSATION TREATMENT	56

10.4.1	CONDENSATE VOLUME	57
10.5	BURNER MAINTENANCE.....	57
10.5.1	BURNER REMOVAL.....	57
10.5.2	BURNER CLEANING PROCEDURE	57
10.6	CHANGING THE HOT SURFACE IGNITER.....	58
10.6.1	RE-INSTALLING THE IGNITER	58
10.7	HEAT EXCHANGER INSPECTION	58
10.8	RE-INSTALL HEAT EXCHANGER	58
10.9	COMBUSTION AIR FAN.....	58
10.10	COMBUSTION AND VENTILATION AIR	58
10.11	CONTROL CIRCUIT VOLTAGE	58
10.12	COMBUSTIBLE MATERIALS	58
10.13	FREEZE PROTECTION	58
10.14	FREEZE PROTECTION FOR A HEATING BOILER SYSTEM (Optional)	59
PART 11	INSTALLATIONS.....	59
11.1	CHECKING THE INSTALLATION.....	59
11.2	CHECKING THE INSTALLTION	59
11.3	INSPECT & RECHARGE CONDENSATE COLLECTION & NEUTRALIZING RESERVOIR.....	59
11.4	HEATING BOILER INSTALLATIONS.....	60
11.5	WATER CONNECTIONS.....	60
11.6	PIPING LENGTHS	60
11.7	INTERMITTENT PUMP OPERATION	60
11.8	SUMMARY	60
11.9	DOMESTIC HOT WATER HEATER.....	61
11.10	WATER VELOCITY CONTROL	62
11.11	TEMPERATURE RISE AT FULL FIRING RATE.....	62
11.12	WATER HEATERS.....	62
PART 12	EXPLODED VIEW	63
PART 13	ELECTRICAL DIAGRAMS.....	71

PART 1 GENERAL INFORMATION

1.1 INTRODUCTION

The Dynaforce® is a condensing forced draft appliance utilizing a premix power burner based on a push through design which offers several venting options. Heat output is controlled by a one to one air/gas ratio control gas valve which provides seamless modulation. The Dynaforce® provides central heating or domestic hot water at working pressures up to 160 PSI. It is designed for use with a fully pumped and pressurized system. The boiler/water heater will automatically modulate to provide heat outputs between 100% and down to 20%.

The Dynaforce® works on the principle of differential pressure. The operation of the fan will generate a differential pressure, which the gas/air ratio control gas valve will match on the gas side. The steady state efficiency is maintained across the entire range of modulation. Air and gas are metered in precise proportion (1:1 Ratio) to modulation signal, allowing combustion characteristics which determine efficiency to remain the same over entire operating range.

Figure 1: Dynaforce®

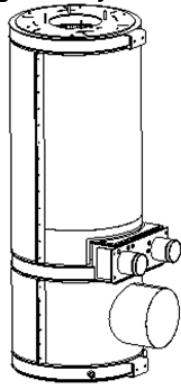

1.2 SPECIAL INSTRUCTIONS TO OWNER

This manual supplies information for the installation, operation and servicing of the appliance. It is strongly recommended that this manual be reviewed completely before proceeding with an installation

CAUTION

It is important that all gas appliances are installed by a qualified installer/technician that is trained by Camus® Hydronics. It is in your own interest and that of safety to ensure that all local codes, and all the following "NOTES" and "WARNINGS" are complied with.

Installing, servicing or adjusting this appliance should be performed only by a qualified installer/technician that is trained by Camus® Hydronics. The serviceman must utilize a combustion analyzer with CO₂, CO, and draft gauge, to set the appliance according to Camus® Hydronics' recommendations, prior to commissioning.

NOTE

RETAIN THIS MANUAL FOR FUTURE REFERENCE

1.3 CHECKING EQUIPMENT

Check for signs of shipping damage upon receiving equipment. Pay particular attention to parts accompanying the boiler, which may show signs of being hit or otherwise being mishandled. Verify total number of pieces shown on packing slip with those actually received. In case there is damage or a shortage, immediately notify carrier.

Figure 2: Checking the Dynaforce®



Do not attempt to pry any panel off. To begin disassembly you must first remove the two ¼" machine screws from the top of the lid. Only then will you be able to remove the lid and disassemble the three outer panels.

Once you have removed the lid carefully check and confirm that all ¼" copper tubing connections are intact and have not broken or loosened in shipment. Leaks at any connections on these lines will result in erratic appliance operation.

1.4 HOW IT OPERATES (SEQUENCE OF OPERATION)

- 1 Supply power connection as per table 10.
- 2 The power switch is placed in the "ON" position.
- 3 120 VAC power is supplied to the control transformer.
- 4 24 VAC is supplied to the ignition module and low voltage controls for all models.
- 5 After the appliance water pump starts, flow is proven by the flow switch and water pressure switch. The water pressure switch is set to close at 30 PSI and is installed in the unit. The flow switch is to be mounted in a tee at the outlet of the appliance. Take care to properly trim the flow switch paddles so as not to jam the switch in the tee. The normally open dry contacts in the low water cutoff (LWCO) are to be wired in series with the normally open contacts of the flow switch. Locate the probe type LWCO in the piping above the highest point of the heat exchanger. The low water cutoff and flow switch are shipped loose. In all cases check with local codes.
- 6 The Dynaforce® controller receives a call for heat via the remote operator contacts and the Demand parameter reads Central Heating or DHW.
- 7 **DR 300 – DR 1000:** The Dynaforce® controller energizes the pump contacts and starts to ramp up the voltage to the electrically commutated DC motor of the combustion fan after internal safety checks are satisfied.

DR1200 – DR5000: The local thermostat energizes the motor stop/start relay which closes the initiate contacts to the variable frequency drive (VFD) which starts to ramp up the frequency to the 230V 3 phase motor of the combustion fan. If the VFD is not in fault mode the frequency will accelerate at the preprogrammed rate towards maximum speed using the modulating signal provided by the on board modulating control or the remote operating system.

- 8 If temperature high limit, water flow and airflow switches are closed the fan will run at pre-purge speed until the pre-purge timer is satisfied. Once complete the Dynaforce® will target the ignition fan speed.
- 9 **DR 300 – DR 2500 (Direct Ignition):** The hot surface igniter will be energized for 22 seconds followed by energizing the main valve for 4 seconds. A signal of 0.8Vdc must be recognized by the controller at the flame sensor to keep the main gas valve in an open position. The fan is kept at ignition speed until the stabilization timer is satisfied.
- DR 3000 – DR 5000 (Proven Pilot):** The Dynaforce® controller will activate the hot surface igniter for 22 seconds followed by powering the pilot valve for 10 seconds, whereupon a signal of 0.8Vdc must be recognized by the controller at the flame sensor to keep the main gas valve in an open position. The fan is kept at ignition speed until the stabilization timer is satisfied.
- 10 If the flame signal is not reached the module will stop the ignition sequence after the trial for ignition.
- 11 The fan speed will slowly decrease as the heat request nears the heat demand. The modulation rate is controlled via Pulse Width Modulation (DR300 – 800) and a 4-20mA signal (DR1000 – 5000). If the heat demand is sustained for a long duration of time the boiler will get to a point of steady-state and the fan will rotate at constant speed.
- 12 When the heat demand is satisfied or is removed the burner will shut off and the fan speed will ramp up to the preset Post-Purge speed until the Post-Purge timer is satisfied.
- 13 The pump continues to circulate until the post-purge time is satisfied.
- 14 The boiler will then go into Standby as it waits for the next heat demand.

Figure 3: Dynaforce® Ignition Cycle

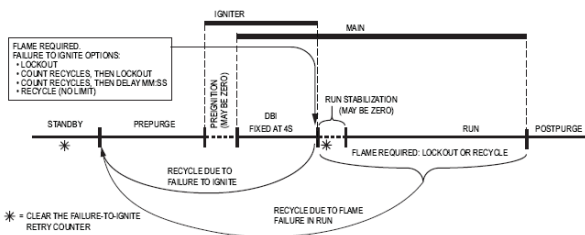

Note:

1. If a flame signal is detected at the end of the pre-purge period an error statement to that effect will appear.
2. If at the end of the safety period (6 sec) no flame is detected the control will go to post-purge to remove the unburned gas. After this, a re-ignition attempt is started following the same cycle. The number of re-ignition attempts is limited to 2 after which a lockout occurs.
3. The burner can only be on continuously for a period of 24 hours. After this the burner is switched off and a restart sequence follows.

4. The hot surface igniter is de-energized at the end of the ignition period to allow for ionisation detection.

1.4.1 HEAT TRANSFER PROCESS

- 1 Burner input continues to increase until water temperature reaches the set point temperature.
- 2 Burner input may stabilize at a fixed rate when demand equals input.
- 3 Burner input will decrease rate when water temperature approaches temperature set point.

1.4.2 END OF SEQUENCE

- 1 Set point temperature is satisfied.
- 2 Power to the gas valves is turned off.
- 3 Combustion air fan ramps to a stop over the factory preprogrammed time period of 60 seconds.
- 4 Thermostat is now in a standby mode waiting for the next "Call for Heat".

WARNING
To minimize the possibility of serious personal injury, fire or damage to your appliance, never violate the following safety rules.
WARNING
IMPROPER INSTALLATION, ADJUSTMENT, ALTERATION, SERVICE OR MAINTENANCE can cause injury or property damage. Refer to this manual. For additional information, consult a qualified installer, service agency or gas supplier.

DO NOT
Do not use this appliance if any part of it has been under water . The possible damage to a flooded appliance can be extensive and present numerous safety hazards. Any appliance that has been under water must be replaced

WHAT TO DO IF YOU SMELL GAS
Do not try to light any appliance. • Do not touch any electric switch: do not use any phone in your building. • Immediately call your gas supplier from a neighbor's phone. Follow the gas supplier's instructions. • If you cannot reach your gas supplier, call the fire department.

IMPORTANT
Consult and follow local Building and Fire Regulations and other Safety Codes that apply to this installation. Contact the local gas utility company to authorize and inspect all gas and flue connections.

Installation and service must be performed by Camus® qualified factory trained service technicians.

WARNING
Should overheating occur or the gas supply fails to shut off, DO NOT turn off or disconnect the electrical supply to the pump. Shut off the gas supply at a location external to the appliance.

- Boilers and water heaters are heat producing appliances. To avoid damage or injury, do not store materials against the appliance or the vent-air intake system. Use proper care to avoid unnecessary contact (especially children) with the appliance and vent-air intake components.
- Never cover your appliance, lean anything against it, store trash or debris near it, stand on it or in any way block the flow of fresh air to your appliance.

- **UNDER NO CIRCUMSTANCES** may flammable materials such as gasoline or paint thinner be used or stored in the vicinity of this appliance, vent-air intake system or any location from which fumes could reach the appliance or vent-air intake system.
- A gas appliance that draws combustion air from the equipment room where it is installed must have an adequate supply of fresh air circulating around it during burner operation for proper gas combustion and proper venting.

1.5 CODES

The equipment shall be installed in accordance with those installation regulations in force in the local area where the installation is to be made. These shall be carefully followed in all cases. Authorities having jurisdiction shall be consulted before installations are made. In the absence of such requirements, the installation shall conform to the latest edition of the National Fuel Gas Code, ANSI Z223.1 and/or CAN/CGAB149 Installation Code. All electrical wiring must be done in accordance with the requirements of the authority having jurisdiction or, in the absence of such requirements, with National Electrical Code, ANSI/NFPA70 and/or the Canadian Electrical Code part 1 CSA C22.1. Where required by the authority having jurisdiction, the installation must conform to American Society of Mechanical Engineers Safety Code for Controls and Safety Devices for Automatically Fired Boilers, ASME CSD-1. All boilers conform to the latest edition of the ASME Boiler and Pressure Vessel Code, Section II. Where required by the authority having jurisdiction, the installation must comply with the CSA International, CAN/CGA-B149 and/or local codes. This appliance meets the safe lighting performance criteria with the gas manifold and control assembly provided, as specified in the ANSI standards for gas-fired units, ANSI Z21.13.

1.6 WARRANTY

- Factory warranty (shipped with unit) does not apply to units improperly installed or improperly operated.
- Factory warranty shall apply only when the appliance is installed in accordance with local plumbing and building codes, ordinances and regulations, the printed instructions provided with it and good industry practices.
- Excessive **water hardness** causing a lime build-up in the stainless steel coils or tubes is not a fault of the appliance and is not covered by warranty. Consult the factory for recommendations for use in hard water areas (See Water Treatment and Water Chemistry).
- Using or storing **corrosive chemicals** in the vicinity of this appliance can rapidly attack the stainless steel tubes and coils and voids warranty.
- Damage caused by **freezing or dry firing** voids warranty.
- This appliance is not to be used for **temporary heating** of buildings under construction.
- **System operating water pressure at boiler not drop below 30 PSIG.**
- The manufacturer shall **NOT** be held liable for any personal injury or property damage due to ice formation or the dislodging of ice from the vent system or the vent termination

1.7 REMOVAL OF EXISTING APPLIANCE

When an existing appliance is removed from a common venting system, the common venting system is likely to be too large for proper venting of the appliances remaining connected to it. At the time of removal of an existing appliance, the following steps must be followed with each appliance remaining connected to the common venting system placed in operation, while the other appliances remaining connected to the common venting system are not in operation.

- Seal any unused openings in the common venting system.
- Visually inspect the venting system for proper size and horizontal pitch and determine that there is no blockage, restriction, leakage, corrosion or other deficiency, which could cause an unsafe condition.
- Insofar as is practical, close all building doors and windows and all doors between the space in which the appliances remaining connected to the common venting system are located and other spaces of the building. If applicable turn on the clothes dryers and any appliances not connected to the common venting system. Turn on any exhaust fans, such as range hoods and bathroom exhausts, so they will operate at maximum speed. Do not operate a summer exhaust fan. Close fireplace dampers.
- Place in operation the appliance being inspected. Follow the lighting instructions. Adjust thermostat so that appliance operates continuously.
- If provided, test for spillage at the draft control device relief opening after 5 minutes of main burner operation. Use a cold mirror, the flame of a match, or candle or smoke from a cigarette.
- After it has been determined that each appliance remaining connected to the common venting system properly vents when tested as outlined above, return doors, windows, exhaust fans, fireplace dampers and any other gas-burning appliance to their previous condition of use.
- Any improper operation of the common venting system should be corrected so that the installation conforms to the National Fuel Gas Code, ANSI Z223.1/NFPA 54 and/or the Natural Gas and Propane Installation Code, CAN/CGA B149.1, Installation Codes. When resizing any portion of the common venting system, the common venting system should be resized to approach the minimum size as determined using the appropriate tables in Chapter 13 of the National Fuel Gas Code, ANSI Z223.1/NFPA 54 and /or the Natural Gas and Propane Installation Code, CAN/CGA B149.1, Installation Codes.

Heat exchanger surfaces and vent piping should be checked every six months for deterioration and carbon deposits. Remove all soot or other obstructions from the chimney and flue, which might impede draft action. Replace any damaged or deteriorated parts of the venting system. A qualified service technician should follow this procedure when inspecting and cleaning the heat exchanger and vent pipe.

1. Turn off electrical power and main manual gas shut-off and allow appliance to cool down.
2. Remove the vent pipe running to the chimney and check heat exchanger, vent and chimney for obstruction and clean as necessary.
3. Remove burner from appliance and carefully clean as required. Never brush or wipe the knitted metal fiber surface, use a garden hose to rinse burner.
Caution: Never use a pressure washer to clean the burner.
4. Use a pressure washer to clean heat exchanger if necessary.
5. Reinstall parts removed in steps 2 and 3. Be sure that vent pipe has proper pitch and is properly sealed. Replace any damaged gasket. Note that the burner is supplied with two gaskets; a high temperature graphite-backed ceramic paper gasket under the burner flange and a stamped silicon gasket between the burner flange and fan flange. Tighten fan flange mounting nuts to 20 ft-lb on DR300 – 1000 and 25 ft-lb on DR1200 - 5000.
6. Restore electrical power and gas supply to appliance.
7. Place appliance in operation using lighting instructions provided.
8. Confirm proper operation of all safety devices
9. Check for gas leaks and proper vent operation.

NOTE:
Experience has shown that improper installation or system design, rather than faulty equipment, is the cause of most operating problems

1.8 BOILER ROOM OPERATING CONDITION

- Due to low jacket losses from the appliance, temperatures in a typical boiler room may drop significantly; supplemental heat is required to maintain ambient temperature at acceptable levels.

1.9 CLEARANCE FROM COMBUSTIBLE MATERIAL

This appliance is suitable for alcove (a closet without a door) installation with minimum clearances to combustibles as follows:

Table 1: Clearances from combustibles

Clearances from Combustibles			
TOP	12"	REAR	12"
SIDES	12"	VENT	6"

Figure 4: Clearance from Combustibles

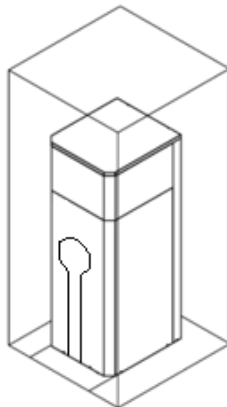

When placing the appliance be aware that a minimum clearance of 24" (60cm) must be provided at the front to allow easy access to the heat exchanger.

When installed directly on combustible flooring, the appliance shall be installed on a metal panel extending beyond the full width and depth of the appliance by at least 3 inches (76.2mm) in any direction. The floor must be strong enough to support the full weight of the heater.

NOTE: Clearances from combustible construction are noted on the appliance rating plate. Maintain minimum specified clearances for adequate operation. All installations must allow sufficient space for servicing the vent connections, water pipe connections, circulating pump, bypass piping and other auxiliary equipment, as well as the appliance

Table 2: Service Clearances

Service Clearances					
Model	Service Clearance, Inches (cm)				
	Top	Right Side	Left Side	Back	Front
300	24" (60cm)	12" (30cm)	12" (30cm)	*	24" (60cm)
350	24" (60cm)	12" (30cm)	12" (30cm)	*	24" (60cm)
400	24" (60cm)	12" (30cm)	12" (30cm)	*	24" (60cm)
500	24" (60cm)	12" (30cm)	12" (30cm)	*	24" (60cm)
600	24" (60cm)	12" (30cm)	12" (30cm)	*	24" (60cm)
800	24" (60cm)	12" (30cm)	12" (30cm)	*	24" (60cm)
1000	24" (60cm)	12" (30cm)	12" (30cm)	*	24" (60cm)
1200	24" (60cm)	12" (30cm)	12" (30cm)	*	24" (60cm)
1400	24" (60cm)	12" (30cm)	12" (30cm)	*	24" (60cm)
1600	24" (60cm)	12" (30cm)	12" (30cm)	24" (60cm)	24" (60cm)
1800	24" (60cm)	12" (30cm)	12" (30cm)	24" (60cm)	24" (60cm)
2000	24" (60cm)	12" (30cm)	12" (30cm)	24" (60cm)	24" (60cm)
2500	24" (60cm)	12" (30cm)	12" (30cm)	24" (60cm)	24" (60cm)
3000	24" (60cm)	12" (30cm)	12" (30cm)	24" (60cm)	24" (60cm)
3500	24" (60cm)	12" (30cm)	12" (30cm)	30" (76cm)	24" (60cm)
4000	24" (60cm)	12" (30cm)	12" (30cm)	30" (76cm)	24" (60cm)
4500	24" (60cm)	12" (30cm)	12" (30cm)	36" (91cm)	24" (60cm)
5000	24" (60cm)	12" (30cm)	12" (30cm)	36" (91cm)	24" (60cm)

* Allow adequate space for the venting in addition to 6" clearance to combustibles.

1.10 INSTALLATION PROCEDURE AND LOCATION OF UNIT

Install this appliance in a clean, dry location with adequate air supply.

- Do not locate this appliance in an area where it will be subject to freezing unless precautions are taken. Radiant losses from the Dynaforce® are minimal and should not be relied on to keep the appliance room warm.
- The appliance should be located close to a floor drain in an area where leakage from the appliance or connections will not result in damage to the adjacent area or to lower floors in the structure, it is recommended that a suitable drain pan, adequately drained, be installed under the unit. Under no circumstances is the manufacturer to be held responsible for water damage in connection with this unit, or any of its components.
- If the appliance is installed above the level of the building's radiation system, a low water cut-off device must be installed above the heat exchanger inlet/outlet connections. Some local codes require the installation of a low water cut-off on all systems
- When placing the appliance be aware that a minimum clearance of 24" must be provided at the front to allow easy access to the heat exchanger.
- A service clearance of 24" must be provided above the top panel to allow access to the burner.
- The appliance must be installed so that the ignition system components are protected from water (dripping, spraying, etc.) during appliance operation and service (circulator replacement, control replacement, etc.)
- Appliances located in a residential garage and in adjacent spaces that open to the garage and are not part of the living space of a dwelling unit must be installed so that all burners and burner ignition devices have a minimum clearance of not less than 18" (46cm) above the floor. The appliance must be located or protected so that it is not subject to physical damage by a moving vehicle.
- **DO NOT** install this appliance in any location where gasoline or flammable vapors are likely to be present.
- **DO NOT** install this appliance on top of carpet flooring
- Appliance must be installed on a level floor. Maintain required clearances from combustible surfaces.
- The appliance designed for indoor installation (Indoor Models) must be installed indoors where it is protected from exposure to wind, rain and weather.
- The appliance designed for outdoor installation (Outdoor Models) must be installed outdoors. For outdoor installations, always consider the use of a shelter such as a garden shed in lieu of direct exposure of the appliance to the elements. The additional protection afforded by the shelter will help to minimize nuisance problems with electrical connections and will allow easier servicing of the appliance under severe weather conditions.

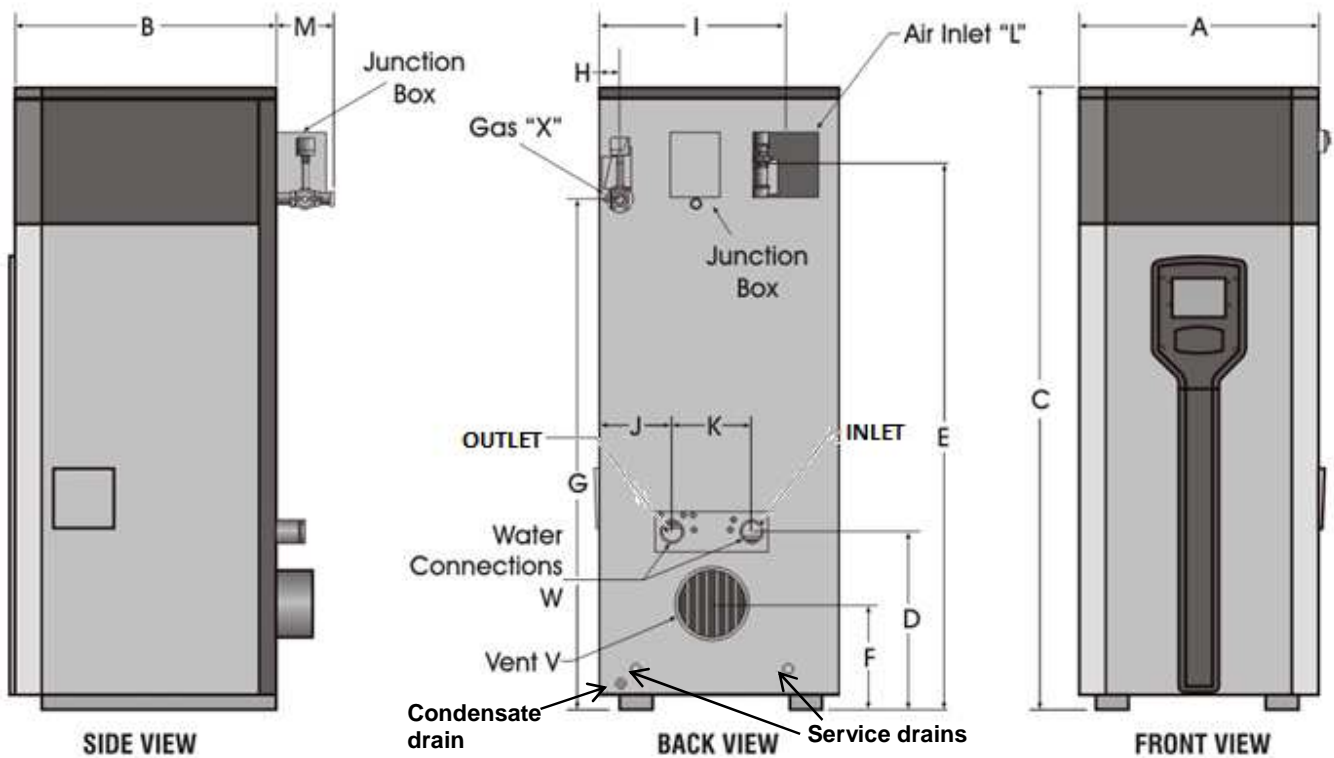

Table 3: Appliance Dimensions and Specifications

Dynaforce® Dimensions

Model	Dim. "A" (in.)	Dim. "B" (in.)	Dim. "C" (in.)	Dim. "D" (in.)	Dim. "E" (in.)	Dim. "F" (in.)	Dim. "G" (in.)	Dim. "H" (in.)	Dim. "I" (in.)	Dim. "J" (in.)	Dim. "K" (in.)	Ø Dim. "L" (in.) Air Inlet (As shipped)	Ø (in.) Air Inlet up to 100 Ft. Equiv. Length	Ø Dim. "V" (in.) Vent CAT. IV up to 100 Ft. Equiv. Length (As Shipped)	Ø Dim. "V" (in.) Vent CAT. II	Dim. "M" (in.)	Ø Dim. "W" (in.) Water (Groove Lock)	Ø Dim. "X" (in.) Gas	Weight (lbs.)
0300	25	27	42	15 1/2	34 7/8	9 3/4	31 1/4	6 3/4	4 3/4	11 7/8	6	6	4	4	4	5	1 1/2	3/4	380
0350	25	27	42	15 1/2	34 7/8	9 3/4	31 1/4	6 3/4	4 3/4	11 7/8	6	6	4	4	5	5	1 1/2	3/4	380
0400	25	27	48 3/4	16 3/8	41 7/8	10 1/2	39 3/4	9 3/4	3 3/4	12	6	6	5	4	5	5	1 1/2	1	430
0500	25	27	48 3/4	16 3/8	41 7/8	10 1/2	39 3/4	9 3/4	3 3/4	12	6	6	5	5	5	5	1 1/2	1	430
0600	25	27	55 1/4	18 1/2	46	11 1/2	45 7/8	10 1/2	4 5/8	12	6	8	6	5	6	5	2	1	480
0800	25	27	55 1/4	18 1/2	46	11 1/2	45 7/8	10 1/2	4 5/8	12	6	8	6	6	6	5	2	1	480
1000	25	27	65	20 3/4	57	13	56 5/8	10 3/8	4 3/8	12	6	8	8	6	7	5	2*	1	580
1200	29 3/8	31 3/4	70 1/2	20 3/4	59 1/2	13	56 3/8	1 7/8	23 1/4	12	6	10	8	7	8	5	2 1/2	1 1/4	620
1400	29 3/8	31 3/4	73 1/2	22 5/8	62 1/2	14	59 1/4	1 7/8	23 1/4	12	6	10	8	7	8	5	2 1/2	1 1/4	700
1600	29 3/8	31 3/4	73 1/2	22 5/8	62 1/2	14	59 1/4	1 7/8	23	12	6	12	10	7	9	5	2 1/2	1 1/4	880
1800	29 3/8	31 3/4	73 1/2	22 5/8	62 1/2	14	59 1/4	1 7/8	23	12	6	12	10	8	9	5	2 1/2	1 1/4	880
2000	29 3/8	31 3/4	81 1/4	24 5/8	72 3/8	14 3/8	69	1 7/8	22 3/4	12 1/2	6 1/2	12	10	8	10	5	3	1 1/4	910
2500	29 3/8	31 3/4	82 5/8	25	74	15 3/4	69 1/2	1 7/8	22 1/2	11 1/4	6 1/2	12	12	9	10	5 1/2	3	1 1/2	1000
3000	35 3/4	39 1/4	85 1/4	25 5/16	75 3/16	16	70 1/2	1 7/8	27 3/4	14	7 3/4	12	12	9	10	5 1/2	3	1 1/2	1350
3500	35 3/4	39 1/4	93	27 1/4	82 1/4	15 1/2	76 1/4	4 1/2	27 3/4	12	12	12	12	10	12	7	4	2	1500
4000	35 3/4	39 1/4	93	25 1/4	82 1/4	15 1/2	76 1/4	4 1/2	27 3/4	12	12	12	12	10	12	7	4	2	1500
4500	35 3/4	39 1/4	96	29	81 1/4	16 1/2	79 1/4	4 1/2	28	12	12	14	14	12	12	7 1/2	4	2 1/2	1650
5000	35 3/4	39 1/4	102	29 1/2	87 1/2	16 3/4	85 1/2	4 1/2	27 3/4	12	12	14	14	12	12	8	4	2 1/2	1750

* 2-1/2" Connection at heat exchanger

PART 2 VENTING

▲ DANGER

It is extremely important to follow these venting instructions carefully. Failure to do so can cause severe personal injury, death or substantial property damage.

▲ DANGER

Use of cellular core PVC (ASTM F891), cellular core CPVC or Radel® (polyphenosulfone) in venting systems shall be prohibited.

2.1 GENERAL VENTING GUIDE

Figure 5: Venting Configurations

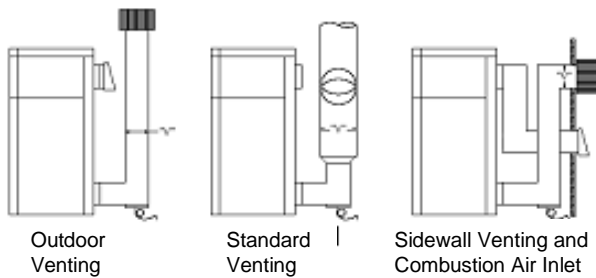

The Dynaforce® is a category II condensing appliance, up to 99% efficient unit.

- The Dynaforce® may be vented with manufactured prefabricated UL/ULC listed vents of AL29-4C or 316L stainless steel or with plastic vent certified to UL/ ULC S636, such as, IPEX System 636 CPVC, IPEX System 636 PVC or IPEX System 636 PP as permitted by local jurisdictions.
- The Dynaforce® boiler must be vented and supplied with combustion and ventilation air as described in this section. Ensure that the venting and combustion air supply complies with these instructions regarding the vent system, air system, and combustion air quality.
- Provisions for combustion and ventilation air are to be in accordance with the section "Air for Combustion and Installation", Of the National Fuel Gas Code, ANSI Z223.1/NFPA 54, or clause 8.2, 8.3, 8.4 of "Natural Gas and Propane Installation Code", CAN/CSA B149.1.2, or appliance provisions of the local building codes.
- The distance of the vent terminal from adjacent buildings, windows that open and building openings MUST comply with the latest edition of the National Fuel Gas Code, ANSI Z223.1, in Canada, the latest edition of CAN/CGA Standard B149 Installation Code for Gas Burning Appliances and Equipment.
- Vent connection is made directly to the flue outlet opening on the back of the unit.
- For indoor installations venting must be in accordance with Part 7, Venting of Equipment, of the National Fuel Gas Code, ANSI Z223.1, or Section 7, Venting of Equipment and Air Supply for Appliances, of the CAN/CGA B149, Installation Codes, or applicable provisions of the local building codes.
- Horizontal runs of vent pipe shall be securely supported (approximately every 4 feet) to prevent sagging and maintain a minimum upward slope of ¼" per foot from the appliance to the vent terminal.

- The weight of the venting system must not rest on the unit. Adequate support of the venting system must be provided in compliance with local codes and other applicable codes.
- All connections should be secured and sealed per the vent manufacturers specifications. When a Positive vent system is disconnected for any reason, the flue must be reassembled and resealed according to the vent manufacturer's instructions.
- Do not use an existing chimney as a raceway if another appliance or fireplace is vented through the chimney.

2.1.1 CATEGORY II AND CATEGORY IV VENTING

A Category II venting system operates with a negative pressure in the vent.

The Category IV venting system operates with positive pressure generated by the internal combustion air fan which operates the combustion process and also exhausts the flue products from the building.

- The Category II flues from multiple appliances can be combined into a common vent, this special venting system must be engineered by venting manufacturer and to be approved by local authority.
- The Category IV flues from multiple appliances **CAN NOT** be combined into a common vent.
- The Category IV flue must be a dedicated stack.
- The Category IV Flue appliance must have all vent joints and seams sealed gas-tight
- The flue products in the vent system will be cooled below their dew point and form condensate in the flue and must use AL29-4C, 316L Stainless, S636 CPVC, and S636 PVC and PPE up to 12" diameter.
- The flue from a Category II and IV vent system must have a condensate drain with provisions to properly collect, neutralize and dispose of any condensate that may occur.

2.1.2 VENTING GUIDELINES FOR CATEGORY II AND/OR IV VENTING

- The installed length of the positive pressure category IV flue from the appliance to the point of termination, outside of the building, **must not exceed a maximum of 100 equivalent feet (30.5M) in length.** Depending on diameter and centerline radius subtract from 7 to 19 feet per 90° elbow using published data. Subtract half this value for each 45° elbow.
- For site conditions exceeding 100 equivalent feet an engineered vent system approved by the local authority will be required.
- The flue may terminate either vertically at the roof top or horizontally on a SIDEWALL. See the information about the specific vent termination location for recommended location and clearances.

2.1.3 APPROVED VENTING MATERIALS

Exhaust Vent for Use for Dynaforce® Category II or IV Installations

- 1 Manufactured prefabricated UL/ ULC listed vent of AL29-4C or equivalent, Single or Double Wall.
- 2 316L stainless steel is limited to use in applications where there is no possibility of contaminants in the air such as refrigerants, chlorine etc.
- 3 "BH" type.
- 4 PVC and CPVC Schedule 40 or 80 approved to ULC S636
- 5 PVC-DWV approved to comply with ANSI/ASTM D2665 (US Jurisdictions ONLY when permitted)
- 6 PVC Schedule 40 approved to comply with ANSI/ASTM D1785 (US Jurisdictions ONLY when permitted)
- 7 CPVC Schedule 40 approved to comply with ANSI/ASTM F441. (US Jurisdictions ONLY when permitted)
- 8 Polypropylene approved to comply with ULC S636 up to 12" diameter.

NOTE	
1)	Use of cellular core PVC (ASTM F891), cellular core CPVC or Radel® (polyphenosulfone) in venting systems is prohibited.
2)	Covering non-metallic vent pipe and fittings with thermal insulation is prohibited.

Table 4: Maximum Flue Temperature for Various Vent Materials

Vent Material	Maximum Flue Temperature [°F]
PVC	149
CPVC	194
Polypropylene	230
AL29-4C	300+, limited only by rating of seals
316L Stainless Steel	300+, limited only by rating of seals

Stack temperature is 10-15°F above boiler inlet temperature when operating at steady-state.

Vent material selection

When selecting vent material take into consideration that appliances installed near a corrosive or potentially corrosive air supply must be isolated from it or they will suffer damage to the appliance and the venting system.

The corrosion resistance of AL29-4C is typically higher than that of 316L. Always choose the venting system which best satisfies the requirements of the application.

This recommendation does not supersede local codes or the provision of the B149 in Canada or the National Fuel Gas Code in the United States

Single wall air intake pipes are to be insulated 5 feet from wall toward the interior of the building to minimize external sweating.

Intake Air (Supply Air, or Fresh Air) Piping for Direct Vent Applications

Air intake material must be of a type listed by a nationally recognized testing agency.

- 1 **PVC** Non Foam Core Pipe.
- 2 **CPVC** Non Foam Core Pipe.
- 3 **Polypropylene**
- 4 **ABS** (Acrylonitrile-Butadiene-Styrene).

Single wall vent pipes to be insulated 5 feet from wall toward the interior of the building to minimize external sweating.

2.1.4 VENT TERMINATION CLEARANCES

- Do not terminate the vent in a window well, stairwell, alcove, courtyard or other recessed area. The vent cannot terminate below grade. The bottom of the vent terminal shall be located at least 12 inches (30cm) above grade and above normal snow levels. In all cases the appliance shall be installed in accordance with local codes.
- The vent outlet **MUST NOT** terminate below a forced air inlet at any distance.
- The vent cannot terminate below grade. Position the vent termination where vapours will not damage walls or plants or may otherwise be objectionable.
- The vent terminal shall not be installed closer than 3 feet (1 m) from an inside corner of an L-shaped structure, window well, stairwell, alcove, courtyard or other recessed area as wind eddies could affect boiler performance or cause recirculation.
- **DO NOT** terminate closer than 4 feet (1.25m) horizontally and vertically from any electric meter, gas meter, regulator, relief valve, or other equipment. In all cases local codes take precedence
- Position terminations so they are not likely to be damaged by foreign objects, or exposed to a build-up of debris.
- The vent piping must terminate in an elbow pointed outward or away from the air inlet.
- To avoid a blocked flue condition, keep the vent cap/terminal clear of snow, ice, leaves, debris, etc.
- Flue gases from this appliance may contain large amounts of water vapour that will form a white plume in winter. Plume could obstruct a window view.
- Flue gas condensate can freeze on exterior walls or on the vent cap. Frozen condensate on the vent cap can result in a blocked flue condition. Some discoloration to exterior building surfaces can be expected. Adjacent brick or masonry surfaces should be protected with a rust resistant sheet metal plate.

2.1.5 INLET CAP FOR ROOFTOP TERMINATION

The air inlet cap consists of two 90° elbows installed at the point of termination for the air inlet pipe. The first 90° elbow is installed on the rooftop at the highest vertical point of the air inlet pipe and turned horizontal; the second 90° elbow is screened and is installed on the horizontal outlet of the first elbow and turned down. A 90° elbow and a 90° street elbow may be used to make this assembly. If a straight piece of pipe is used between the two elbows, it should not exceed 6" (150mm) in length.

2.1.6 LOCATION OF A ROOFTOP AIR INLET AND VENT CAPS

- The point of termination for the combustion air inlet cap MUST be at least 3 feet (0.91M) below the point of flue gas termination (vent cap) if it is located within a 5 foot (1.5M) radius of the flue outlet. Use care to ensure that the 90° elbow assembly is properly installed on the air inlet pipe.
- The termination point of the combustion air inlet cap must be installed at least 3 feet (0.91M) above the rooftop and above normal snow levels.
- The vent cap assembly MUST be listed by nationally recognized agencies.
- Combustion air supplied from outdoors must be free of contaminants. To prevent recirculation of flue products in to the combustion air inlet, follow all instructions in this section.
- Incorrect installation and/or location of the air inlet cap can allow flue products to be drawn back into the appliance. This can result in incomplete combustion and potentially hazardous levels of carbon monoxide in the flue products. This will cause operational problems with the appliance and if left uncorrected, will lead to conditions that can cause personal injury or death.

Figure 6: Vertical Direct Venting Configuration

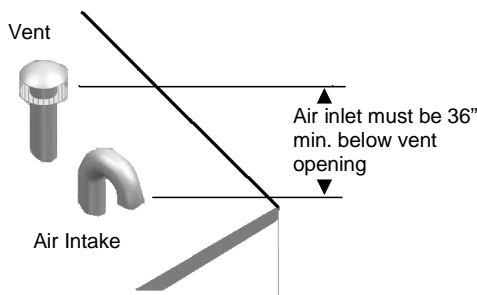

2.1.7 AIR INLET DAMPER

In cold climates it is essential to provide a motorized air inlet damper to control the supply of combustion air and prevent nuisance condensation.

Figure 6: Air Inlet Damper Connection inside J-Box

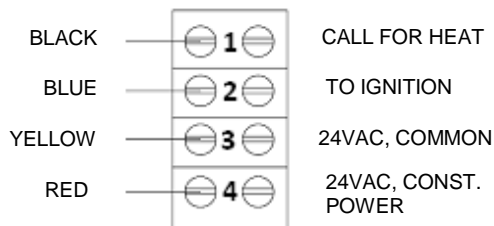

2.1.8 MASONRY CHIMNEY INSULATIONS

Always follow local codes when venting this appliance into a masonry chimney. A standard masonry chimney must NOT be used to vent the products of combustion from the flue of a condensing, positive or negative pressure appliance (Category II or IV). If a masonry chimney is to be used, the chimney MUST use a sealed, corrosion resistant liner system to vent flue products from this high efficiency appliance. Sealed, metallic, corrosion resistant liner systems (AL29-4C or equivalent, single wall or double-wall, or flexible or rigid metallic liners) must be rated for use with a high efficiency

condensing, positive pressure vent system. Corrosion resistant chimney liner systems are typically made from a high grade of corrosion resistant stainless steel such as AL29-4C or equivalent. The corrosion resistant liner must be properly sized and fully sealed throughout the entire length. If the flue is contained within the masonry chimney both the top and the bottom of the masonry chimney must be capped and sealed to provide a dead air space around the sealed corrosion resistant liner.

Consult with local code officials to determine code requirements or the advisability of using a masonry chimney with a sealed corrosion resistant liner system.

2.1.9 VERTICAL VENTING TERMINATION

- Follow Category II or IV vent termination and all General instructions.
- The vent terminal should be vertical and exhaust outside the building at least 2 feet (0.61M) above the highest point of the roof within a 10 foot (3.05M) radius of the termination.
- The vertical termination must be a minimum of 3 feet (0.91M) above the point of exit.
- A vertical termination less than 10 feet (3.05M) from a parapet wall must be a minimum of 2 feet (0.61M) higher than the parapet wall.

2.1.10 COMBINED COMBUSTION AIR INLET

The air inlet pipes from multiple appliances can be combined to a single common connection if the common air inlet pipe has a cross sectional area equal to or larger than the total area of all air inlet pipes connected to the common air inlet pipe.

Equivalent pipe diameter = Sq Root $[(d_1)^2 + (d_2)^2 + (d_3)^2 + (d_4)^2 + \dots + (d_n)^2]$, d, pipe diameter

❖ Example: What is equivalent pipe diameter of three air inlet pipes, 8" (20.3 cm), 10" (25.4 cm) and 12" (30.5 cm)

Equivalent pipe diameter = Sq Root $[(8)^2 + (10)^2 + (12)^2]$ = Sq Root (308) = 17.5", Select 18" (46.7 cm) diameter pipe or larger.

The air inlet point for multiple boiler air inlets must be provided with an exterior opening which has a free area equal to or greater than the total area of all air inlet pipes connected to the common air inlet. This exterior opening for combustion air must connect directly to the outdoors. The total length of the combined air inlet pipe must not exceed a maximum of 100" (25.4M) equivalent feet. You must deduct the restriction in area provided by any screens, grills or louvers installed in the common air inlet point. Screens, grills or louvers installed in the common air inlet can reduce the free area of the opening from 25% to 75% based on the materials used. Calculate and compensate accordingly for the restriction.

2.1.11 DRAIN TEE

Figure 7: Drain “T” and Neutralizer Cartridge Installation

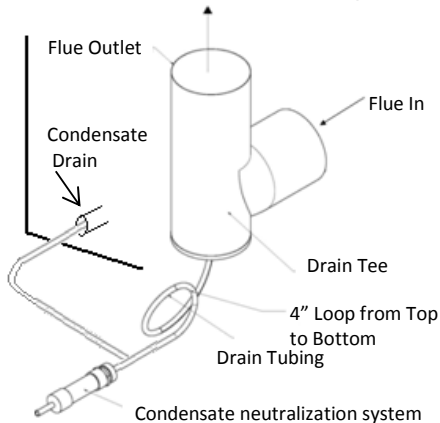

A drain line must be connected to the boiler condensate drain and to a tee installed in the vent pipe to collect and dispose of any condensate that may occur in the boiler and vent system. The drain tee should be installed at the point where the flue turns vertical for a roof top termination or as one of the first fittings in a horizontal flue that will terminate on a SIDEWALL. Ensure that horizontal portions of the vent are properly sloped away from the appliance to allow condensate to be evacuated at the drain tee. Plastic drain tubing, sized per the vent manufacturer's instructions, shall be provided as a drain line from the tee and from the boiler condensate line. The drain tubing from the tee must have a trap provided by a 4" (10cm)-diameter circular trap loop in the drain tubing and the boiler drain shall be normal with no loop and tied into the tee drain tubing with a tee at a point after the 4" loop and before the neutralizer. Prime the trap loop by pouring a small quantity of water into the drain hose before assembly to the vent. Secure the trap loop in position with nylon ties. Use caution not to collapse or restrict the condensate drain line with the nylon wire ties. The common condensate drain must be routed to the condensate neutralization system or a suitable drain for disposal of condensate that occurs in both the boiler and in the vent system. Ensure that the drain from the condensate tee is not exposed to freezing temperature.

2.2 CONVENTIONAL VENTING (INDOOR) INSTALLATIONS

- The Dynaforce® is a category II appliance and is approved for venting into a common Chimney. On single appliance installations with dedicated chimney, if drafts are excessive (above negative 0.15 Inches W.C.), we recommend a single acting barometric damper.
- A qualified professional using a proven vent-sizing program with input of accurate operating parameters must properly do sizing of the venting system. In applications where flue gas temperatures are lower than can support a Category II with conventional negative draft, it will be determined at the venting design stage that a positive pressure will be developed in the vent. It will then be necessary to either provide separate vents as for Category IV, pressurize the room or to provide an extractor at the chimney outlet interlocked with the appliance operating circuit in order to maintain a negative draft in the chimney and allow common venting.
- Approval of the installation will be at the discretion of authorities having jurisdiction.

IN GENERAL

- The operation of exhaust fans, compressors, air handling units etc. can rob air from the room, creating a negative pressure condition leading to reversal of the natural draft action of the venting system. Under these circumstances an engineered air supply is necessary.
- If the appliance is to be installed near a corrosive or potentially corrosive air supply, the appliance must be isolated from it and outside air should be supplied as per code.
- Potentially corrosive atmospheres will result from exposure to permanent wave solution, chlorinated waxes and cleaners, chlorine, water softening chemicals, carbon tetrachloride, halogen based refrigerants, Freon cleaning solvents, hydrochloric acid, cements and glues, masonry washing materials, antistatic fabric softeners, dry cleaning solvents, degreasing liquids, printing inks, paint removers, etc.
- The equipment room MUST be provided with properly sized openings to assure adequate combustion air and proper ventilation when the unit is installed with a proper venting system.

2.2.1 AIR REQUIRED FOR COMBUSTION AND VENTILATION

Provisions for combustion and ventilation air are to be in accordance with the section for “Air for Combustion and Ventilation”, of the National Fuel Gas Code, ANSI Z223.1/NFPA 54, or clause 8.2, 8.3, 8.4 of “Natural Gas and Propane Installation Code”, CAN/CSA B149.1.2, or applicable provisions of the local building codes. If air is taken directly from outside the building with no duct, provide two permanent openings:

- Ventilation of the space occupied by fuel burning appliance(s) or equipment shall be supplied by a ventilation opening at the highest practicable point communicating with the outdoors. The total cross sectional area of the ventilation opening must be either 10% of the net free area required for combustion air or 10 sq. in (6500 mm²), whichever is greater.
- Net free area of combustion air opening shall be in accordance with all applicable codes. In the absence of such codes provide combustion air opening with a minimum free area of one square inch per 7,000 Btuh input (5.5 cm per kW) up to 1,000,000 Btuh and one square inch per 14,000 Btuh in excess of 1,000,000 Btuh. This opening must be ducted no higher than 18" nor less than 6" above the floor.
- In extremely cold climates when air supply is provided by natural air flow from the outdoors we recommend sizing the combustion air supply opening with a minimum free area of not less than one square inch per 30,000 Btu/hr, of the total rated input of the burner, provided that this does not conflict with local codes. This opening is in addition to the ventilation opening defined in paragraph a) above.

NOTE

Outside air openings shall directly communicate with the outdoors.

CAUTION

Under no circumstances should the mechanical room ever be under a negative pressure. Particular care should be taken where exhaust fan, attic fans, clothes dryers, compressors, air handling units, etc., may take away air from the unit.

2.2.2 EXHAUST FANS

Any fan or equipment which exhausts air from the equipment room may deplete the combustion air supply and/or cause a downdraft in the venting system through a barometric damper if installed. Spillage of flue products from the venting system into an occupied living space can cause a very hazardous condition that must be immediately corrected.

2.3 OUTDOOR VENTING

The Dynaforce® windproof cabinet protects the unit from weather, when fitted with the factory supplied air intake and UL approved vent cap (93-0298), it will be self-venting and suitable for outdoor installation.

1. Outdoor models must be installed outdoors and must use the air intake and vent cap supplied by Camus® Hydronics.
2. Periodically check to ensure that air intake and vent cap are not obstructed.
3. Locate appliance at least 3 feet away from any overhang.
4. Locate appliance at least ten feet from building air intake.
5. Avoid installation in areas where runoff from adjacent building can spill onto appliance.

For outdoor installations, always consider the use of a shelter such as a garden shed in lieu of direct exposure of the appliance to the elements. The additional protection afforded by the shelter will help to minimize nuisance problems with electrical connections and will allow easier servicing of the appliance under severe weather conditions.

2.4 SIDEWALL VENTING

When fitted with the factory supplied vent terminal, the Dynaforce® can vent up to 100 equivalent feet. Elbows can range from 7 to 19 feet in equivalent length depending on centreline radius. Refer to table 3 for vent sizes.

Appliances may be installed with either a horizontal sidewall vent or vertical roof top vent. Terminals differ with each application. Use single wall vent and seal all joints or use pressure rated double wall vent.

When using single wall vent, all vent connector seams and joints must be sealed with pressure sensitive aluminium tape or silicone sealant as specified by the vent manufacturer. Aluminium tape must meet the provisions of SMACNA AFTS-100-73 Standard.

Periodically check to ensure that the vent terminal is unobstructed.

This venting system uses the appliance's internal combustion air fan to force the flue products out horizontally.

The Dynaforce® fan generates a positive pressure in the flue. Combustion air is drawn from the equipment room. Sidewall terminations are available from the factory. Refer to local codes for proper installation and location of vent terminals.

2.4.1 SIDEWALL VENT TERMINAL & SIDEWALL INTAKE AIR TERMINAL

- The sidewall vent terminal kit includes the wall penetration assembly and the discharge screen assembly.
- The opening through the wall for installation of the sidewall vent terminal must provide an air space clearance of 1 inch (2.5cm) around the flue pipe. The diameter of the opening for installation of the sidewall vent terminal will be 2 inches (5cm) larger than the nominal diameter of the installed vent pipe to the sidewall vent cap. The diameter of the opening for the air inlet cap will be the same as the nominal size of the pipe.
- Install the proper vent pipe to the vent terminal (provided by Camus® Hydronics).
- Follow all requirements in the General Venting sections for venting flue products to the outdoors.

2.4.2 LOCATION OF A SIDEWALL VENT TERMINATION

- The vent terminal shall terminate at least 3 ft (1M) above any forced air inlet within 10 ft (3M) horizontally.
- The vent terminal MUST NOT terminate below a forced air intake at any distance.
- Do not terminate the vent in a window well, stairwell, alcove, courtyard or other recessed area. The vent cannot terminate below grade.
- The vent shall not terminate less than 7 ft above a public walkway due to the normal formation of water vapour in the combustion process.
- The vent system shall terminate at least 3 foot (1M) above grade, above normal snow levels and at least 7 ft (2.15M) above grade when located adjacent to public walkways.
- The vent terminal shall not be installed closer than 3 ft (1M) from an inside corner of an L-shaped structure.
- The vent terminal should have a minimum clearance of 4 ft (1.25M) horizontally from and in no case above or below, unless a 4 ft (1.25 m) horizontal distance is maintained from electric meters, gas meters, regulators and relief equipment. In all cases local codes take precedence.
- Flue gas condensate can freeze on exterior walls or on the vent terminal. Frozen condensate on the vent cap can result in a blocked flue condition. Some discoloration to exterior building surfaces can be expected. Adjacent brick or masonry surfaces should be protected with a rust resistant sheet metal plate.

2.4.3 LOCATION OF A SIDEWALL AIR INLET TERMINAL

- The termination point of the sidewall air inlet must be installed a minimum of 3 feet above ground level and above normal levels of snow accumulation.
- The point of termination for the sidewall combustion air inlet terminal **MUST** be located a minimum of 3 feet (1M) horizontally and 12 inches (0.30M) below the point of flue gas termination (vent cap) if it is located within a 10 foot (3M) radius of the flue outlet.

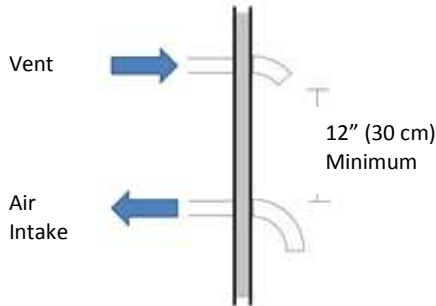

2.4.4 LENGTH OF AIR INLET PIPE

The maximum total length of the sidewall or vertical roof top combustion air inlet pipe as installed from the appliance to the air inlet terminal must not exceed (100 ft) equivalent feet (30.5m) in length. Subtract 7 (2.13 m) to 19 feet (5.8 m) of equivalent length depending on centreline radius for each 90° elbow installed in the air inlet pipe system. Pressure drop in 45° elbow will be half as much.

PART 3 GAS CONNECTION

Verify that the appliance is supplied with the type of gas specified on the rating plate. Consult factory for installations at high altitude.

3.1 GAS CONNECTION

- Safe operation of unit requires properly sized gas supply piping. See gas line sizing data.
- Gas pipe size may be larger than appliance connection.
- Installation of a union at the appliance gas line connection is required for ease of service and removal of the gas train.
- Install a manual main gas shutoff valve, outside of the appliance gas connection as require by local codes.
- A trap (drip leg) **MUST** be provided in the inlet gas connection to the appliance.
- Optional gas controls may require routing of bleeds and vents to the atmosphere, outside the building when required by local codes.
- Larger models of this appliance may be supplied with a gas pressure relief valve. This valve is designed to relieve lockup pressure in excess of the high gas pressure switch setting. It must be piped to discharge excess gas pressure through the valve to a safe location in accordance with local codes. Follow table 5 for sizing the vent line.

Table 5: Gas Pressure Relief Valve – Vent Manifold Sizing Chart

Qty. of Pressure Relief Valves being combined	Size of Combined Vent Line (Sch. 40 pipe)*	
	Pressure Relief Valve Size - 3/4" NPT	Pressure Relief Valve Size - 1" NPT
1	3/4"	1"
2	1"	1 1/4"
3	1 1/4"	1 1/2"
4	1 1/4"	2"
5	1 1/2"	2"
6	1 1/2"	2"
7	2"	2 1/2"
8	2"	2 1/2"

* Up to 50 feet. Increase by one pipe size for every 50 feet or part thereof that the vent line extends beyond the initial 50 feet. The increase is to be made at the connection to the relief valve.

Table 6: Recommended Gas Pipe Size

Single Appliance Installation

(For distance from natural gas meter or propane second stage regulator)

Input Btu/Hr, x1000	0-100 FT		101-200 FT		201-300 FT	
	NAT.	L.P.	NAT.	L.P.	NAT.	L.P.
300	1 ¼"	1"	1 ½"	1 ¼"	1 ½"	1 ¼"
350	1 ¼"	1"	1 ½"	1 ¼"	1 ½"	1 ¼"
400	1 ¼"	1"	1 ½"	1 ¼"	2"	1 ½"
500	1 ½"	1 ¼"	2"	1 ½"	2"	1 ½"
600	1 ½"	1 ¼"	2"	1 ½"	2"	1 ½"
800	2"	1 ½"	2"	1 ½"	2 ½"	2"
1000	2"	1 ½"	2"	1 ½"	2 ½"	2"
1200	2"	1 ½"	2 ½"	2"	2 ½"	2"
1400	2 ½"	2"	2 ½"	2"	3"	2 ½"
1600	2 ½"	2"	3"	2 ½"	3"	2 ½"
1800	2 ½"	2"	3"	2 ½"	3"	2 ½"
2000	2 ½"	2"	3"	2 ½"	3"	2 ½"
2500	3"	2 ½"	3"	2 ½"	3 1/2"	3"
3000	3"	2 ½"	3"	2 ½"	3 1/2"	3"
3500	3"	2 ½"	3 ½"	3"	4"	3 ½"
4000	3 ½"	3"	4"	3 ½"	4"	3 ½"
4500	3 ½"	3"	4"	3 ½"	4"	3 ½"
5000	4"	3 ½"	4"	3 ½"	5"	4"

3.2 GAS PIPING

All gas connections must be made with pipe joint compound resistant to the action of liquefied petroleum and natural gas. All piping must comply with local codes and ordinances.

3.3 INSTALL PIPING

- The gas line should be sufficient to handle the total installed capacity. Verify pipe size with gas supplier.
- Use new, properly threaded black iron pipe free from burrs. Avoid flexible gas connections. Internal diameter of flexible gas lines may not provide appliance with proper volume of gas.
- Install a manual main gas shutoff valve at the appliance gas inlet, outside of the appliance and before the gas valve. Install a joint union at the appliance gas line connection for ease of service and removal of the gas train.
- Run gas pipe to appliance gas inlet.
- Install a sediment trap in the supply line to the appliance gas inlet.
- Apply a moderate amount of good quality pipe compound.
- For LP gas, consult your LP gas supplier for expert installation.

The appliance and its individual gas shut-off valve must be disconnected from the supply piping when pressure testing the gas supply piping at pressures above ½ PSI

Table 7: Gas Pressures at Inlet to Appliance

	PROPANE	NATURAL GAS
Minimum (inches W.C.)	11	4.5*
Maximum (inches W.C.)	11	14

* 7" w.c. recommended regulator setting

The gas supply line must be of adequate size to prevent undue pressure drop and must never be smaller than the size of the connection on the appliance. Sizing based on Table 6 is recommended.

Before operating the appliance, the complete gas train and all connections must be tested using soap solution.

Verify that the appliance is supplied with the type of gas specified on the rating plate. Heating values of local natural gas are to be between 950 and 1010 Btu/ft³. Consult factory if heating values are outside this range or if a gas with a mixture of constituents is being used.

3.4 AIR/GAS RATIO VALVE

The main gas valves supplying gas to the burner for models 2000 to 5000 on this appliance utilize a servo pressure regulator providing a slow opening, fast closing safety shut off and an air/gas ratio control valve for the gas combustion process. This gas valve controls the pressure difference across the flow orifice in the manifold supply line as a function of the pressure difference across the combustion air supply to the burner. The actuator maintains a constant air to gas ratio as the volume of air changes based on the operation of the combustion air fan. The valve is a 1:1 differential pressure air/gas ratio controller. The valve generates the same pressure difference on the gas side as it senses on the air side. Models 300 to 1800 utilize a 1:1 ratio dual seat negative pressure gas valve. Models 2000 – 3000 utilize a 1:1 air/gas ratio control valve and a safety solenoid valve. Models 3500 – 5000 utilize a 1:1 air/gas ratio control and regulating gas valve. The regulating gas valve performs the functions of a pressure regulator, safety shutoff. Full closing of the valve seat occurs in less than 0.8 seconds when the valve is de-energized. Operation of the gas valve in combination with the combustion air fan allows the burner input rate to vary from 20% to 100% based on temperature demand. The inlet gas supply pressure must be maintained within the specified minimum and maximum pressures.

The air/gas ratio is preset at the factory and adjustment is not usually required if gas supply pressure is maintained within the specified range.

There are no serviceable parts on the dual seat negative pressure air/gas ratio valve control.

A reduction of up to 30% is permitted in the inlet gas pressure between light off and full fire conditions.

If the manifold differential pressure is to be measured, refer to section 3.8 Checking Differential Air and Gas Pressures for proper measurement.

Figure 8: DR300 – 400 1:1 Negative Pressure Air/Gas Ratio Control Valve

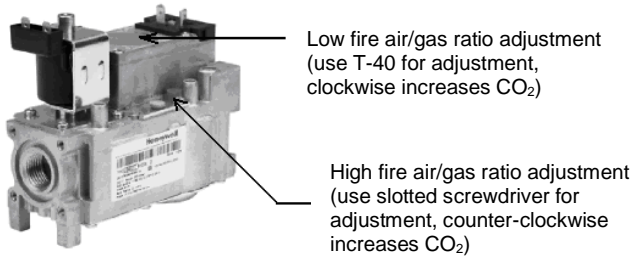

Figure 9: DR500 – 1800 1:1 Negative Pressure Air Gas Ratio Control Valve

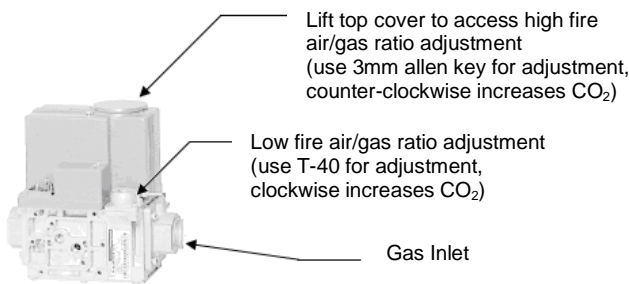

Figure 10: DR2000 - 5000 1:1 Air/Gas Ratio Control Valve

Low fire adjustment screw
Located under cap
(Turning clockwise increases

Junction box for
power with
actuator position
indicator

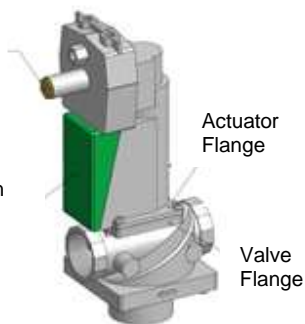

Figure 11: DR3500 – 5000 SKP25 Regulating Gas Valve Actuator & SSOV



3.5 DIFFERENTIAL AIR PRESSURE (DR2000 – DR5000)

- The Dynaforce® 2000 – 5000 operates on the principle of differential pressures. Operation of the fan generates a signal which is matched on the gas side by the 1 to 1 air/gas ratio control valve.
- The differential air pressure measurement is made between the high and low pressure taps across the fan discharge and the fan static discharge. All differential air pressures are noted at full firing rate. There are two pressure taps at the fan discharge and care must be taken to tee into the correct line. The correct line may be identified by tracing it back to the ratio control valve where the identification of the tapping is stamped into the die cast actuator.
- The differential gas pressure measurement is made between the high and low pressure taps across the in-line metering gas orifice. Check this value to confirm that it matches the differential air pressure while the appliance is firing.
- The controls on this appliance may fire the burner from 20% up to 100 % of rated input.
- Differential manifold gas pressure will be reduced as burner input is reduced.
- All reference gas pressure measurements must be made at 100% of rated burner input.
- The differential gas manifold pressure is pre-set at the factory through the ratio gas valve. Adjustment of manifold pressure is not normally required for proper operation. It may be necessary to adjust the low fire adjustment screw located on the ratio control valve actuator in order to achieve acceptable light off under soft start field conditions.
- **Always check settings posted on boiler test label.**

3.6 GAS MANIFOLD DIFFERENTIAL PRESSURE ADJUSTMENT (DR2000 – DR5000)

Tampering with gas valve adjustments after startup and commissioning will void the warranty on the gas valve assembly and the burner.

The appliance's manifold gas pressure **IS NOT** field adjustable after startup and commissioning. The gas valve pressure ratios have been factory set with an internal bias adjustment to ensure a 1:1 air/gas ratio on operation. Tampering with this adjustment will void the warranty on the gas valve assembly and the burner. An appliance supplied with a properly sized gas line, properly sized meter and a minimum gas supply pressure (See Table 7 for minimum allowable inlet gas supply pressure) while firing at full rate will ensure full burner input. The manifold pressure supplied to the burner is a differential pressure. This pressure is the result of the difference in two gas pressure measurements. A differential manifold gas pressure measurement should not be made until you have measured the gas supply pressure. Gas supply pressure must be at least at minimum allowed with all appliances on the gas line firing at full rate before a manifold pressure measurement is made. Use the following procedure to check gas supply pressure with a manometer connected to the inlet pressure tap on the gas line connection at the rear of the appliance.

3.7 CHECKING GAS SUPPLY PRESSURE

- Turn the main power switch to “OFF” position.
- Shut off gas supply at the manual gas cock in the gas piping to the appliance. If fuel supply is LP gas, shut off gas supply at the tank.
- **Models 300 – 3000:** Remove the 1/8" hex plug from the gas pressure test port located on the inlet gas supply connection at the rear of the appliance. Install a fitting in the inlet pressure tapping suitable to connect to a manometer or magnahelic gauge. Range of scale should be 0 to 14 inch W.C. or greater to check inlet pressure
- **Models 3500 – 5000:** Remove the 1/8" hex plug downstream of the SKP25. Install a fitting in the inlet pressure tapping suitable to connect to a manometer or magnahelic gauge. Range of scale should be 0 to 14 inch W.C. or greater to check inlet pressure
- Turn on gas supply at the field installed manual gas cock; turn on LP gas at tank if required.
- Turn the power switch to “ON” position.
- Adjust the thermostat set point to call for heat.
- Observe the gas supply pressure as the burner fires at 100% of rated input.
- Ensure inlet pressure is within specified range. Minimum and maximum gas supply pressures are specified in Table 7.
- If gas pressure is out of range, contact the gas utility, gas supplier, qualified installer or service agency to determine necessary steps to provide proper gas pressure to the control.
- If gas supply pressure is within normal range, proceed to remove gas manometer and replace pressure tap fittings in the gas piping to the appliance.
- Turn on gas supply at the manual valve; turn on LP gas at tank if required.
- Turn the power switch to “ON” position.
- Adjust the thermostat temperature set point to the desired water temperature so the appliance will call for heat.
- Check appliance performance by cycling the system while you observe burner response. The burner should ignite promptly. Flame pattern should be stable, see “Maintenance-Normal Flame Pattern.” Turn system off and allow burner to cool, then cycle burner again to ensure proper ignition and flame characteristics.

IMPORTANT

Upon completion of any testing on the gas system, leak test all gas connections with a soap solution while the main burner is firing. Immediately repair any leak found in the gas train or related components. DO NOT operate an appliance with a leak in the gas train, valves or related gas piping.

3.7.1 Regulated Gas Supply Pressures for Dynaforce® Boilers & Water Heaters

A stable gas supply pressure is important to avoid rough starts with machines like the Dynaforce® which use a 1 to 1 ratio control valve for internal gas pressure regulation.

Camus® requires that all Dynaforce® models equipped with the SKP25 be supplied with no more than 1 PSI incoming supply pressure. This means that lockup pressure must not exceed 1 PSI. For models **NOT** incorporating the SKP25, lockup pressure must not be in excess of 14" w.c.

A suitable lockup regulator with internal or external relief will not exceed running pressure by more than 20%.

When required a final stage gas regulator is to be located as close as possible but no more than 10 feet from the appliance.

It is paramount that maximum lockup pressure be confirmed before any attempt is made to start up the appliance.

Operating the Dynaforce® at lockup pressures exceeding the recommended levels can lead to delayed ignitions and damage to the appliance.

3.8 CHECKING DIFFERENTIAL AIR AND GAS PRESSURES (DR2000 – DR5000)

Figure 12: Checking Differential Air and Gas Pressures (DR2000 – DR5000)

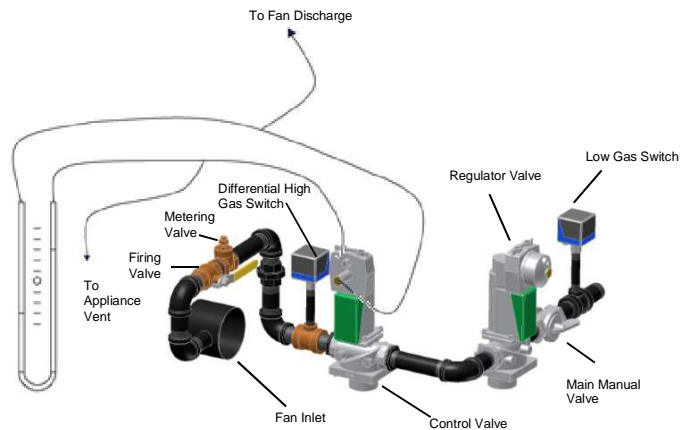

- The 1 to 1 air/gas ratio control actuator has embossed markings identifying + air, - air, + gas & - gas connections. Using a test hose assembly fitted with tees, connections can be made from the manometer to the appropriate ports on the actuator.
- Using tees connect a hose from the positive air and the negative air to each of the two sides of a manometer. This will allow the two pressure points to be measured while at the same time the actuator still receives the proper operating signal.
- If a second manometer is available it can be connected to the appropriate gas ports. Typically the gas signal will closely follow the air signal on all models. If the incoming gas pressure reduces significantly as the VFD accelerates to maximum speed the gas signal may lag behind the air signal by up to 15%. This will occur once the actuator has driven downwards as far as it can go. The amount that the actuator has opened is registered by an indicator arm which is visible through the view window.
- As the appliance comes on and fires, record the maximum inches of water column which is achieved at maximum speed on the VFD using start-up report form (93-0130). To adjust this differential pressure when commissioning the appliance, use the adjusting screw on the air shutter to the fan. In all cases the final adjustment is to be made using a combustion analyzer. Depending on field conditions differential pressures will have to be adjusted accordingly. Typically with long lateral runs the differential signal as read will be reduced from the value shown on the

rating plate. The opposite will occur with tall stacks where drafts exceed negative 0.15"W.C.

- If the appliance will not light off it will be necessary to adjust the low fire as explained in the detailed start-up procedure.

3.9 GAS TRAIN AND CONTROLS

Figure 13: Typical Gas Train (DR2000 – 3000)

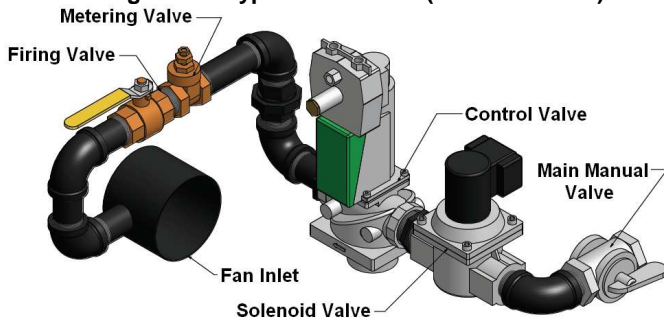
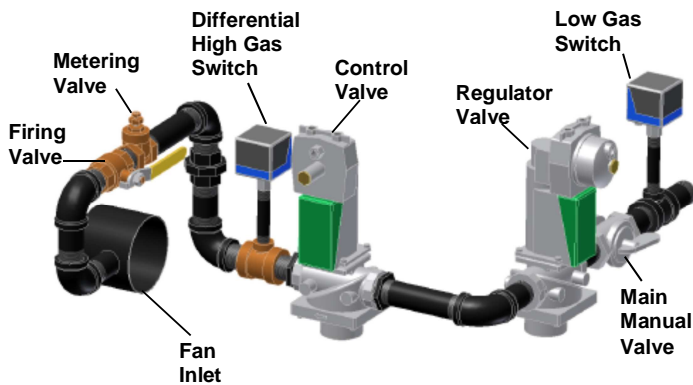

Figure 14: Typical Gas Train (DR 3500 – 5000)



3.10 VENTING OF GAS VALVES AND PRESSURE SWITCHES

The optional gas pressure switches may be provided with threaded termination points to be vented to the atmosphere, outside the building. The gas pressure regulation function is provided by the ratio gas valve which does not require installation of a vent line. The optional gas pressure switches are installed in the upper chamber of the appliance. Threaded vent line connections from components requiring an external vent line are provided on the component. These vent line connection points may be accessed by removing the top of the appliance. Local codes may require the routing of these bleeds and vents to the atmosphere, outside the building. Proper routing of vent lines to the atmosphere from the factory supplied termination points is the responsibility of the installing contractor.

3.11 BURNER

Figure 15: Burner

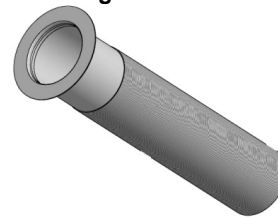

This appliance uses a single cylindrical burner installed vertically into the cavity located in the center of the heat exchanger. There is a unique burner for each one of the 18 models.

Burners **MAY NOT** be interchanged between different Btu/hr input models. The burner consists of a round mounting flange welded to a mixing tube. The top side of the mixing tube provides the transition which mounts the discharge from the combustion air fan into the burner. The bottom side of the mixing tube is attached to a stainless steel perforated sleeve. This stainless steel sleeve is covered with a knitted alloy material that forms the burner port surface. The knitted burner port material is a metal fiber material which is a unique alloy of iron, chrome, aluminum and several rare earth metals. This alloy is designed to operate stress free as a burner port surface. The burner port surface can sustain operation from a blue flame down to infrared conditions as the burner input varies. In order to maximize the operating life of the burner, the normal operating mode for the Dynaforce® is a blue flame. Infrared operation will occur only if air to gas adjustments are incorrect. If infrared operation is noted the cause must be corrected.

Model 300 – 2500: Direct ignition is standard. The burner mounting flange provides a flame view port and the mounting point for the hot surface igniter and the flame sensor.

Model 3000 – 5000: Proven pilot ignition is standard. The burner mounting flange provides a flame view port, the mounting point for the hot surface igniter, a connection to the pilot tube and the flame sensor.

The hot surface igniter and flame sensor are removable from the burner mounting flange without removing the burner assembly from the heat exchanger.

Never use an open flame (match, lighter, etc.) to check gas connections.

PART 4 WATER CONNECTION

- * Check all applicable local heating, plumbing and building safety codes before proceeding.
- * If the appliance is installed above radiation level it must be provided with a low water cut-off device at the time of appliance installation (available from factory). Some local codes require the installation of a low water cut-off on all systems.
- * **A pressure relief valve is supplied with each Dynaforce®. The relief valve must be mounted in a vertical position and piped to the floor in a manner acceptable to the enforcing authority.**
- * **Minimum water operating system pressure should not drop below 30 PSIG.**
- * Be sure to provide unions and gate valves at inlet and outlet to the appliance so that it can be easily isolated for service. The provision of a flow setter valve at the appliance outlet will facilitate setting of the proper flow at the desired temperature rise at high fire. It is particularly important to confirm proper temperature rise for domestic hot water applications. Improper flows can lead to premature tube failure from scaling and will not be covered by warranty.
- * This appliance is a low mass design which provides for instant heat transfer. Special attention to water flow rates will ensure that temperature rise is not excessive. See Table 8 and 9.
- * To eliminate trapped air, install venting devices at high points in the system as well as in the piping on the suction of the pump and in the piping on the discharge of the appliance.
- * Use suitable pipe hangers or floor stands to support the weight of all water and gas piping.
- * Always pump toward the heat exchanger inlet. Never pump away from the exchanger since this will result in a low-pressure zone, which will allow localized boiling and result in heat exchanger damage.
- * Dynaforce® must be installed so that the gas ignition system components are protected from water (dripping, spraying, rain, etc.) during appliance operation and service (circulator replacement, control replacement, etc.)

Figure 16: Typical Space Heating System

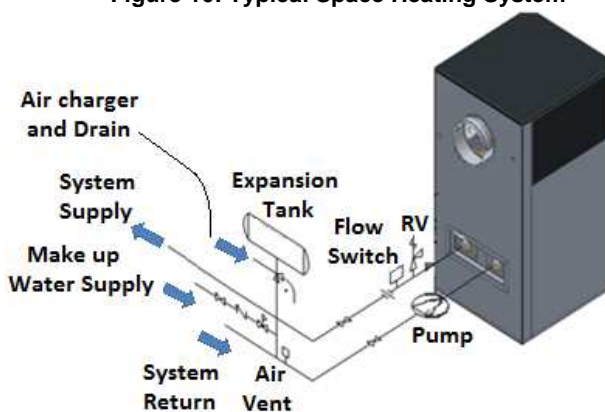

4.1 FREEZE PROTECTION

- * Appliance installations are not recommended outdoors in areas where danger of freezing exists unless precautions are taken. Maintaining a mixture of 50% water and 50% propylene glycol is the preferred method of freeze protection in hydronic systems. This mixture will protect the appliance to approximately -35°F (-37°C). To maintain the same temperature rise across the appliance increase the GPM flow by 15% and the head loss by 20%.

The following example demonstrates the procedure to follow for calculating the revised head for the heat exchanger when using a water / glycol mixture.

- Given that Camus® is showing a heat exchanger flow and head loss of 100 gpm @ 10 feet
 - Increasing the flow by 15% now results in a head loss of 13 feet at 115 gpm (from B&G system syzer). At this increased flow Camus® now recommends to increase the head loss by 20%.
 - The requirement for the heat exchanger with water / glycol mixture will now be 115 gpm @ 15.6 feet. (ie. 1.2 x 13ft. = 15.6 ft.)
 - A similar procedure must be followed to calculate the additional head loss in pipe and fittings in order to arrive at the proper pump selection.
- * For outdoor installations in colder climates a snow screen should be installed to prevent snow and ice accumulation on and around the appliance. Regular inspections should be made to ensure that air intake and vent are free of snow and ice. Always consider the use of a shelter such as a garden shed in lieu of direct exposure of the appliance to the elements. The additional protection afforded by the shelter will help to minimize nuisance problems with electrical connections and will allow easier servicing of the appliance under severe weather conditions.

4.2 WARNING REGARDING CHILLED WATER AND HEATING COIL SYSTEMS

When an appliance is connected to a refrigeration system where the same water is used for heating and cooling, the chiller must be piped in parallel with the appliance. Appropriate flow control valves; manual or motorized must be provided to prevent the chilled water from entering the appliance.

The appliance piping system of a hot water boiler connected to heating coils located in air handling units where they may be exposed to refrigerated air circulation must be equipped with flow control valves or other automatic means to prevent gravity circulation of the boiler water during the cooling cycle.

Figure 17: Chilled Water System

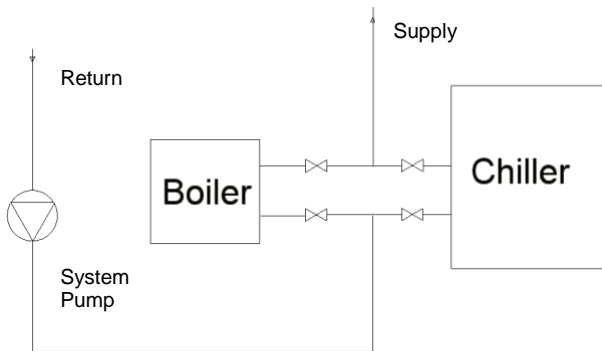

4.3 INLET AND OUTLET CONNECTIONS

- All water connections are groove-lock fittings.
- For ease of service, install unions on inlet and outlet of the appliance. The connection to the appliance marked “Inlet” on the header should be used for return from the system. The connection on the header marked “Outlet” is to be connected to the supply side of the system.

4.4 MINIMUM PIPE SIZE REQUIREMENTS

The equivalent number of straight feet of pipe for each valve and fitting in the connecting piping must be considered to properly arrive at the total equivalent feet of straight pipe in the field installed piping to the appliance. See the piping requirements in Part 11 - Installation section of this manual. Consult factory if longer piping distances are required for a specific application.

4.5 HEAT EXCHANGER

This appliance uses stainless steel fin tubing to maximize the heat transfer process. The heat exchanger is comprised of vertical tubes welded directly into two circular stainless steel headers. This heat exchanger is designed to withstand 160 PSIG working pressure. A series of “V” shaped baffles are installed between the individual tubes to control the movement of the flue products over the finned tubes to maximize efficiencies. When servicing, take special care to ensure that baffles are properly located and maintained in factory condition. Replace any damaged baffles including factory supplied ceramic facing tape.

A factory recommended circulating pump ensures proper water flow during burner operation and creates enough water turbulence inside the stainless steel tubes and header that prevents the formation of sediments. Temperature rise and scale formation in the heat exchanger are controlled by the selection of a properly sized circulating pump.

The Camus® designs are versatile and user friendly, they deliver optimal performance by taking full advantage of existing site conditions in order to maximize energy savings.

4.6 LOW WATER TEMPERATURE SYSTEMS

In applications where the heating system requires supply water temperatures below 110°F, connections may be made directly to the Dynaforce®. At incoming temperatures of 80°F or lower the Dynaforce® achieves maximum efficiency. **Inlet temperatures must not drop below 40°F to prevent freezing.**

4.7 INSTANTANEOUS WATER HEATER

An instantaneous water heater is designed to deliver hot water without the use of a storage tank. It is suitable for applications with variable load such as restaurants, condominiums, apartments and motels and typically used in conjunction with tempering valves to achieve temperature control. In some applications it may be appropriate to provide a flow through tank to act as a buffer. Consult factory for recommendations. (See Figure 18)

Figure 18: Typical Instantaneous Water Heating System

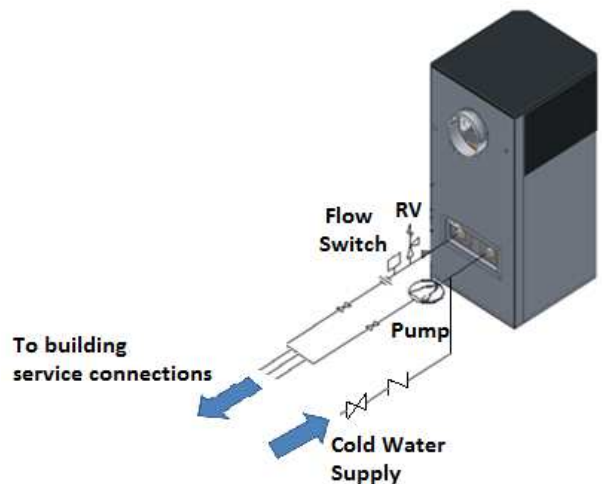

Table 8: Flow and Pressure Drop at a Given Temperature Rise (DR300-1000)

Model	10°F Rise		15°F Rise		20°F Rise*	
	US GPM	ΔP-Ft.	US GPM	ΔP-Ft.	US GPM	ΔP-Ft.
300	57.0	0.5	38.0	0.3	-	-
350	66.5	0.7	44.3	0.4	-	-
400	76.0	1.0	50.1	0.5	-	-
500	95.0	1.6	63.3	0.8	-	-
600	113.9	2.5	75.9	1.3	-	-
800	152.0	6.6	101.3	3.2	76.0	1.9
1000	189.8	11.4	126.5	5.4	95.0	3.2

* Use for hydronic heating applications only

Table 9: Flow and Pressure Drop at a Given Temperature Rise (DR1200-5000)

Model	20°F Rise		25°F Rise		30°F Rise*	
	US GPM	ΔP-Ft.	US GPM	ΔP-Ft.	US GPM	ΔP-Ft.
1200	113.8	10.0	91.0	6.6	75.8	4.7
1400	132.8	14.0	106.2	9.2	88.5	6.5
1600	151.8	14.1	121.4	9.3	101.2	6.5
1800	170.9	14.3	136.7	9.4	113.8	6.7
2000	189.8	20.8	151.8	13.6	126.4	9.7
2500	237.2	27.1	189.8	17.7	158.0	12.5
3000	284.6	27.3	227.7	17.8	189.6	12.7
3500	331.8	33.0	265.4	21.5	221.2	15.3
4000	379.5	36.9	303.6	24.0	253.0	17.1
4500	426.9	55.8	341.5	36.3	284.6	25.6
5000	474.0	60.0	379.2	39.0	316.0	27.5

* Use for hydronic heating applications only

4.8 WATER FLOW SWITCH

A water flow switch is mounted and installed in the outlet piping on all heating boilers and hot water supply boilers. The flow switch is wired in series with the 24VAC safety control circuit.

4.9 LOW WATER CUTOFF (If Equipped)

If this boiler is installed above radiation level, a low water cut-off device must be installed at the time of boiler installation. Some local codes require the installation of a low water cut-off on all systems. Electronic low water cut-offs are available as a factory supplied option on all models. Low water cut-offs should be tested every six months, including flushing of float types. The normally open switch contact of the low water cutoff is to be wired in series with the flow switch. A red diagnostic light will be indicated on the control display on a low flow condition.

Caution: remove jumper when connecting to 24 VAC circuit.

Figure 19: Low Water Cut Off Electrical Connections (Watts)

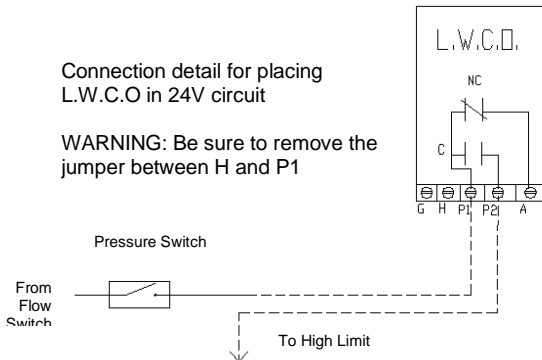
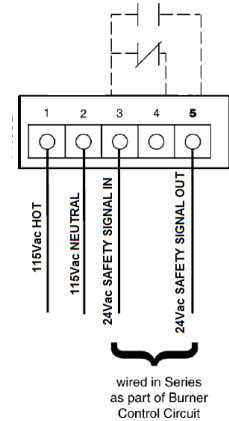

Figure 20: Low Water Cut Off Electrical Connections (ITT)



4.10 RELIEF VALVE

This appliance is supplied with a relief valve sized in accordance with ASME Boiler and Pressure Vessel Code, Section IV ("Heating Boilers"). The relief valve is installed or shipped loose and is installed in the vertical position and mounted in the hot water outlet. No valve is to be placed between the relief valve, and the appliance. To prevent water damage, the discharge from the relief valve shall be piped to a suitable floor drain for disposal when relief occurs. No reducing couplings or other restrictions shall be installed in the discharge line. The discharge line shall allow complete drainage of the valve and line. Relief valves should be manually operated at least once a year. If a relief valve discharges periodically, this may be due to thermal expansion in a closed water supply system. Contact the water supplier or local plumbing inspector on how to correct this situation. Do not plug the relief valve.

CAUTION
Avoid contact with hot discharge water

4.11 CIRCULATING PUMP SELECTION

The appliance has a low mass stainless steel finned tube heat exchanger for fast response and high heat absorption. Selecting the proper pump will ensure that temperature rise does not exceed the maximum recommended for the application and that the heat exchanger tubes are not prematurely scaled or eroded.

4.11.1 CIRCULATING PUMP OPERATION OF HEAT EXCHANGER

MOST IMPORTANT

This appliance is designed for continuous pump operation when the burner is firing. The pump control option allows the appliance circulating pump to be cycled "ON" prior to the burner firing and cycled "OFF" some time after the set point is satisfied.

The operation of the circulating pump is controlled by the Dynaforce® temperature control (SOLA). When the appliance is activated by a remote operating signal the pump will start and run for the operating cycle and for a post purge period based on temperature difference between inlet and outlet connections to the appliance. The SOLA can directly operate pumps up to 1/6 HP. Larger pumps will require a separate relay or contactor.

PART 5 ELECTRICAL & CONTROLS

To select the proper pump it is strongly recommended to consider the following:

- Need to know the required flow (GPM) and pressure drop for your appliance (see Table 8 and 9)
- Type of application: hydronic heating or domestic hot water (DHW).
- For hydronic heating and DHW applications with normal water hardness choose a pump which will result in a temperature rise across the main heat exchanger of 10°F to 25 °F (5.5°C-13.8°C) depending on the size of the heater. If necessary use a flow setter valve to achieve the desired temperature rise.
- For DHW applications with other than normal water hardness choose a pump for the local water hardness conditions. Alternatively run the pump continuously and soften the water to normal levels. Damage to the heat exchanger as a result of scaling or corrosive water conditions is non-warrantable.

NOTE

- The use of a system sensor is required in lead lag operation.
- 1) When variable speed main circulators **ARE NOT** used the system sensor is to be placed into the return system piping.
 - 2) When variable speed main circulators are used the system sensor is to be placed into the supply system piping.

4.12 ΔT HEAT EXCHANGER ALGORITHM

The Dynaforce® is constantly monitoring the inlet and outlet water temperatures on the Dynaforce®, when the ΔT approaches 40°F the burner will modulate down, and when this temperature is exceeded the gas valve will de-energize to prevent overheating the heat exchanger.

⚠ DANGER

IT IS EXTREMELY IMPORTANT THAT THIS UNIT BE PROPERLY GROUNDED!

5.1 ELECTRICAL CONECTIONS

Table 10: Minimum Power Requirements

Model	Voltage Requirement	Maximum Over Current Protection	Full Load Amps
		[Amperes]	[Amperes]
300 - 1000	120VAC, 60Hz	20	< 12.0
1200 - 2000	120VAC, 60Hz	20	14.0
2500	120VAC, 60Hz	30	18.0
3000 - 3500	208/230VAC, 60Hz*	30	20.0
4000 - 5000	208/230VAC, 60Hz, 3 Phase**	30	18.0

*This is a 4-wire power supply requiring two (2) lives, a neutral and a ground

**This is a 5-wire power supply requiring three (3) lives, a neutral and a ground

Dynaforce® boilers supplied at 460/3/60 voltage, differ from the standard unit per the following:

CAUTION!

- While working with 460V circuits it is imperative that extra precautions be taken
- Ensure that lock-out/ tag-out procedures are strictly enforced
 - Only properly trained and authorized personnel should be permitted to work on live electrical circuits
 - All electrical workers should be trained in electrical rescue techniques and CPR

Each unit has an internal factory mounted 500VA transformer to supply the 115V necessary for the ignition circuit. For the incoming power, a 3-wire connection, is made at the rear junction box. A new variable frequency drive replaces the standard VFD, and the combustion blower fan has been configured to operate at 460/3/60V (using the standard fan). Part numbers as well as FLA and MOCOP information is below.

500VA transformer: DC0500UH

VFD:	Model Range:
T234	DR-1200 to DR-1800 (1hp)
T235	DR-2000 to DR-2500(1.5hp)
T237	DR-3000 to DR-3500 (3hp)
T238	DR-4000 to DR-5000 (5hp)

Dynaforce® Model	Voltage Requirement	Maximum Over Current Protection	Full Load Amps
		[Amperes]	[Amperes]
1200 - 2500	460VAC, 60Hz, 3 Phase	10	2.1
3000 - 4000			5.3
4500 - 5000			6.8

The combustion air fan motor operates on 230 VAC, 3 phase, 60 Hz on models DR1200 - 5000. Three phase voltage is generated by the VFD and supplied directly to the fan motor on models 1200 - 5000. Refer to Table 10 for appropriate supply voltage to the appliance. The appliance, when installed, must be electrically grounded in accordance with the requirements of the authority having jurisdiction or in the absence of such requirements, with the latest edition of the National Electrical Code ANSI/NFPA No. 70. When the unit is installed in Canada, it must conform to the Canadian Electrical Code, C22.1, Part 1 and/or local Electrical Codes.

- All wiring between the appliance and field installed devices shall be made with wire having minimum 220°F (105°C) rating.
- Line voltage wire external to the appliance must be enclosed in approved conduit or approved metal clad cable.
- The pump must run continuously when appliance is firing.
- To avoid serious damage, **DO NOT ENERGIZE** the appliance until the system is full of water. Ensure that all air is removed from the pump housing and piping before beginning initial operation. Serious damage may result if the appliance is operated without proper flow.
- Provide the appliance with proper overload protection.

5.2 VARIABLE FREQUENCY DRIVE (DR1200 – 5000)

This appliance uses a VFD which provides power to the combustion fan. The fan motor operates on 230VAC 3 phase power. This three phase voltage is generated by the VFD and supplied directly to the fan motor. The VFD receives a 4-20mA modulating signal from the SOLA to vary the frequency of the voltage supplied to the fan motor from 20 Hz up to 60 Hz. This varies the output of the combustion air fan from 20% up to 100% of capacity corresponding to the same variation in burner input. Once the self checks are completed by the SOLA, the VFD is provided with a signal to operate at soft start level for initial burner ignition. After main burner ignition is established, the modulating signal is generated by the VFD to vary fan speed based on desired water temperature set point.

CAUTION

The voltage output from the variable frequency drive to the combustion air fan is 230VAC, 3 Phase. **AVOID** contact with high voltage wiring

5.3 DIFFERENTIAL AIR PRESSURE SWITCH

Models 300 to 1000 use a fan speed sensing line in the PWM control to prove air flow. A normally open differential air pressure switch is used to prove operation of the combustion air fan on the DR1200 – 5000. The pressure switch sensing points are installed at the fan outlet where air moves into the inlet of the burner. One point measures total pressure (+air) and is connected to a pitot tube facing the flow from the fan

paddle wheel. The other point measures static pressure. Differential pressure at the switch will be affected by blockages at the fan inlet or at the flue discharge. A minimum differential pressure across the sensing points of the pressure switch proves operation of the combustion air fan. This is set in the factory and may be adjusted for field conditions. The diagnostics display will exhibit a status of an open Interrupted Air Switch (ILK Off) when the differential pressure switch detects a sustained low air condition. This condition could be caused by a number of factors including:

- Sensing line broken or loose fitting.
- Dirty filter or blocked vent.
- Steady high wind condition exceeding 40 MPH.
- Incorrectly set switch.
- Missing bleed restrictor on total pressure side air line.

5.4 BLOCKED FLUE SWITCH

All models use a normally closed blocked flue switch to shut down the appliance under the following conditions:

- 1) Air intake 50% blocked
- 2) Vent outlet 80% blocked

5.5 DIFFERENTIAL GAS AND LOW GAS PRESSURE SWITCHES

A manual reset differential gas pressure switch is standard on DR3000 – 5000 and available as an option on DR300 - 2500. If differential gas pressure exceeds the maximum setting of the pressure switch, the appliance will shut down and an open gas pressure switch will be shown on the display. A low gas pressure switch is standard and monitors the minimum incoming gas supply pressure supplied to the gas train. If gas pressure falls below the minimum setting of the pressure switch, the appliance will shut down and an open gas pressure switch will be shown on the display.

5.6 HIGH LIMIT

A high limit aqua-stat control is located at the back of the appliance and the control bulb is installed in a dry well in the heat exchanger header outlet. The setting of this control limits maximum discharge water temperature. A manual reset high limit will have a red reset button which must be pushed whenever water temperature has exceeded the set point of the manual reset limit. The temperature of the water in the heat exchanger must drop a minimum of 15°F (8.3°C) below the setting of the high limit control before the reset function can be activated. Whenever an appliance is supplied with both an auto reset and manual reset high limit always set the auto reset limit 10°F (5.5°C) below the manual reset limit to prevent nuisance tripping

5.7 DYNAFORCE® SOLA

DR300 – DR2500 models utilize a hot surface ignition system. DR3000 – DR5000 models utilize a proven pilot. The ignition control proves the presence of the flame using a flame rectification voltage (0.8Vdc), energizes the main gas valve, proves the presence of main burner flame, and provides for lockouts. The Alarm light will be lit on the ignition control module in the event of a fault.

Figure 21: Ignition Module

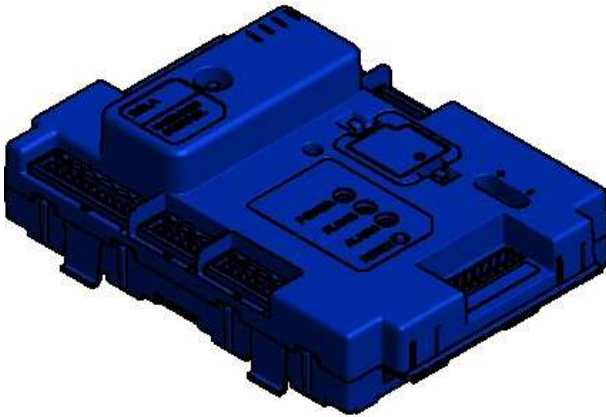

5.7.1 SERVICE PARTS

The electronic ignition module is not repairable. Any modification or repairs will invalidate the warranty and may create hazardous conditions that result in property damage, personal injury, fire, explosion and/or toxic gases. A faulty hot surface igniter or ignition module **MUST BE** replaced with a new factory approved unit only. A factory approved igniter, ignition control module and flame sensor for this specific unit is available from your local distributor. **DO NOT** use general purpose field replacement ignition modules, igniters or sensors. Each appliance has one ignition module, one hot surface igniter and one flame sensor.

5.7.2 IGNITION MODULE LOCKOUT FUNCTIONS

The ignition module may lockout in either a hard lockout condition requiring pushing of the reset button to recycle the control for a CSD1 requirement or a soft lockout condition which may be reset automatically once the error clears. A typical hard lockout fault can occur with single a trial for ignition CSD1 module. Pushing the reset button on the ignition control is the only way to reset an ignition module that is in a hard lockout condition. The reset button is located on the ignition module. Turning the main power “OFF” and then “ON” or cycling the thermostat will not reset a hard lockout condition. Wait until the display shows the temperatures on screen before pushing the reset button when the ignition module is in a hard lockout.

The Dynaforce® Controller will go into an alert condition, for example, if the supply sensor is disconnected, flow switch, or air switch are not made. If the fault is not corrected, the boiler will stay in an alert condition. Once the fault is corrected, the boiler will automatically return to normal operating state.

5.8 DYNAFORCE® CONTROLLER

Table 11: Connector Description

Connector	Connector Description
J1	Flame Sensor, Ground Rod
J2	Fan Modulation (DR300 – 1000)
J3	Display, Lead lag, Modbus Comm.
J4	24VAC Power, Pump, VFD
J5	Gas Valve, Safety Interlock String
J6	Safety Annunciation, Remote Operator
J8	24VAC Power, Inlet, Outlet Sensor
J9	DHW, Stack Sensor

5.9 ERROR TABLE

The following tables provide a description of all the possible errors with the Dynaforce® appliance. Errors can be divided into two groups. Alert errors (will disappear when error is gone) and lockout errors (can only be reset by the RESET button).

When the control is in error the pump will be running. This is done to prevent the freezing of the central heating circuit when the boiler is in error during the winter period. For some non-volatile lockouts the pump will not be running, see table below for more details.

Table 12: Lockout codes

#	Description
1	Unconfigured safety data
2	Waiting for safety data verification
3-46	Internal Fault. Replace SOLA Controller
47	Flame rod to ground leakage
48	Static Flame
49	24VAC low/high
50	Modulation Fault
64	Fan speed not proved, ignition failure
67	Interlock Off, safety circuit is open
79	Heater Outlet high limit tripped
81	Delta T Limit
82	Stack limit tripped (PVC: 149°F, CPVC: 194°F, 250°F)
91	Inlet sensor fault
92	Outlet sensor fault
93	DHW sensor fault
94	Header sensor fault
95	Stack sensor fault
96	Outdoor sensor fault
105	Flame detected out of sequence
106	Flame lost if Main Flame Establishing Period (MFEP)
107	Flame lost early in run
108	Flame lost in run
109, 110	Ignition failed
112	Pilot test flame timeout
113	Flame circuit timeout
149	Flame detected

* If an internal hardware error is detected contact Camus® technical support for troubleshooting procedure.

Figure 22: Lockout Condition

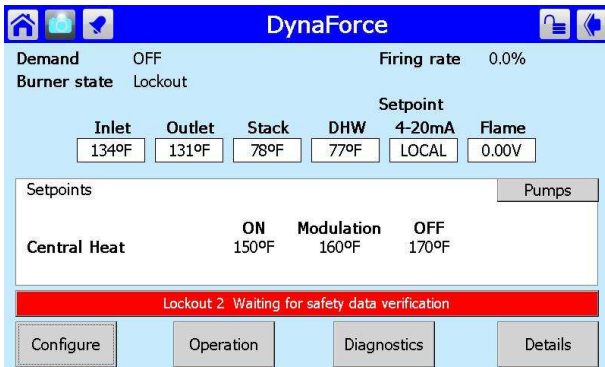

To eliminate the lockout error,

- 1) Press the red bar, indicating a Lockout condition
- 2) Press the **[Lockouts]** button

Figure 23: Lockout History

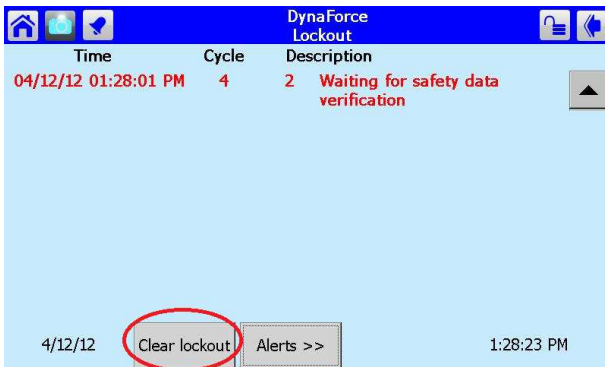

- 3) Press **[Clear Lockout]**

Table 13: Alert/Hold Codes

#	Description
29	Burner switch turned OFF
30	Burner switch turned ON
47	Invalid subsystem reset request occurred
50	Modulation Fault (DR300 – 1000 ONLY)
61	Anti-short Cycle
62	Fan speed not proved
63	LCI off, safety circuit is open
68	Setpoint was overridden due to sensor fault
69	Modulation was overridden due to sensor fault
123	Modulation rate was limited due to outlet limit
124	Modulation rate was limited due to Delta-T limit
215	No Lead Lag slaves available to service demand
219	Using backup Lead Lag header sensor due to sensor failure
229	Lead lag slave communication timeout.
275-281	LCI off, safety circuit is open
283	Demand off during measured purge time
291	Abnormal Recycle: Flame was not on at end of Ignition period
292	Abnormal Recycle: Flame was lost during Main Flame Establishing Period
293	Abnormal Recycle: Flame was lost early in Run
294	Abnormal Recycle: Flame was lost during Run
303-310 ⁺	Interlock Off, safety circuit is open
324, 374-379	Hardware flame bias. Flame sensor wire needs to be re-routed.
352 ⁺	Stack sensor fault
355 ⁺	Outlet sensor fault
357 ⁺	DHW sensor fault
359 ⁺	Inlet sensor fault
460	LCI lost in run
550	Delta T inlet/outlet limit was exceeded

* If an internal hardware fault is detected contact Camus® technical support for troubleshooting procedure.

⁺ The alarm LED and alarm contacts are closed and will remain closed until the 'RESET' button is pressed.

PART 6 CONTROL PANEL

6.1 APPLIANCE TEMPERATURE CONTROLLER

The appliance is provided with a control panel at the front. Operating controls are installed inside the control box and are accessible by undoing the (2) slotted screws and swinging opening the door. The diagnostic information centre as well as the on/off switch and the appliance temperature controls reside on the control box door the ignition control module, VFD, transformer and relays are mounted on the internal panel.

Figure 24: Touchscreen Display



The SOLA icons will appear in one of four colours indicating the boiler status:

Colour	Description
Blue	Normal Operation
Red	Lockout Condition
Yellow	Holding Mode
Grey	Communication Error

The Boiler Temperature Controller for this appliance is the Honeywell SOLA. It initiates the local call for heat and sets the target return (appliance inlet) water temperature. This controller offers a range of operation modes which provides set point as well as modulating control. It provides the following:

- * Readings of inlet and outlet water temperatures as well as flame signal.
- * Operation as an auto reset limit.
- * Operation as a control for inlet water temperature, outlet temperature, system temperature.
- * 40°F ΔT heat exchanger protection algorithm
- * Available tank mounted sensor used in conjunction with inlet sensor.
- * Adjustable; target temp, inter-stage differential, on delay between stages, minimum on time per stage, minimum off time per stage.
- * Display of run hours for maintenance purposes. Counter wraps around at 10000 hours.
- * Flame failure signal.
- * JST and Molex connectors for ease of service.
- * Error message display in text
- * Manual override of boiler input rate for combustion
- * Pump exercising feature runs pump 10 seconds every three days in the event of no pump operation.

Levels of Access

Two levels of access to simplify the use of the boiler.

User – Access to general boiler and display settings and adjustments to the central heating, domestic hot water and lead lag setpoint.

Installer – Access to all user parameters and allows for changes to additional boiler parameters to allow for ease of startup and serviceability.

NOTE

Due to the sensitivity of the touchscreen controller, using the backend of a pen/pencil or stylus is recommended for accuracy

Figure 25: Home Screen

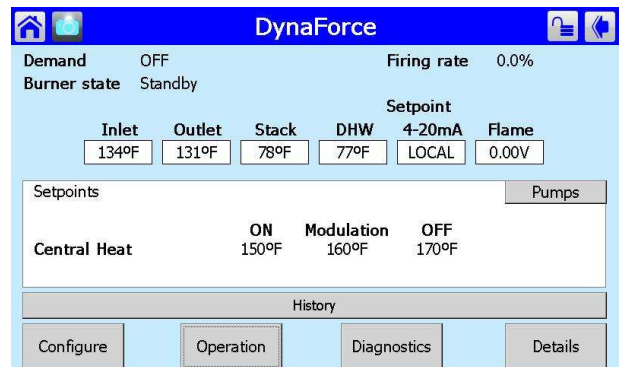

PARAMETER	DESCRIPTION
Demand	Central Heating (DRH)
	Domestic Hot Water (DRW)
Burner State	Current Status of Dynaforce®
Firing Rate	Target Firing Rate
Fan Speed	Actual Firing Rate (DR300 – 1000)
Inlet	Inlet Water Temperature [°F]
Outlet	Outlet Water Temperature [°F]
Stack	Stack Temperature [°F]
DHW	DHW Temperature [°F], if equipped
Lead Lag/ CH	Header Temperature [°F], if equipped
Outdoor	Outdoor Temperature [°F], if equipped
4-20mA	4-20mA input, if equipped

BUTTON	DESCRIPTION
Configure	Access Dynaforce® parameters (CH Parameters, DHW Parameters, Outdoor Reset, Pump Configuration etc.)
Operation	Details of boiler operation (Set point, Firing Rate, Pump Status, Safety circuit)
Diagnostics	Manual firing rate, Analog/ Digital Status
Details	History, Pump Status, Outlet Temperature

Sequence of Operation

Troubleshooting

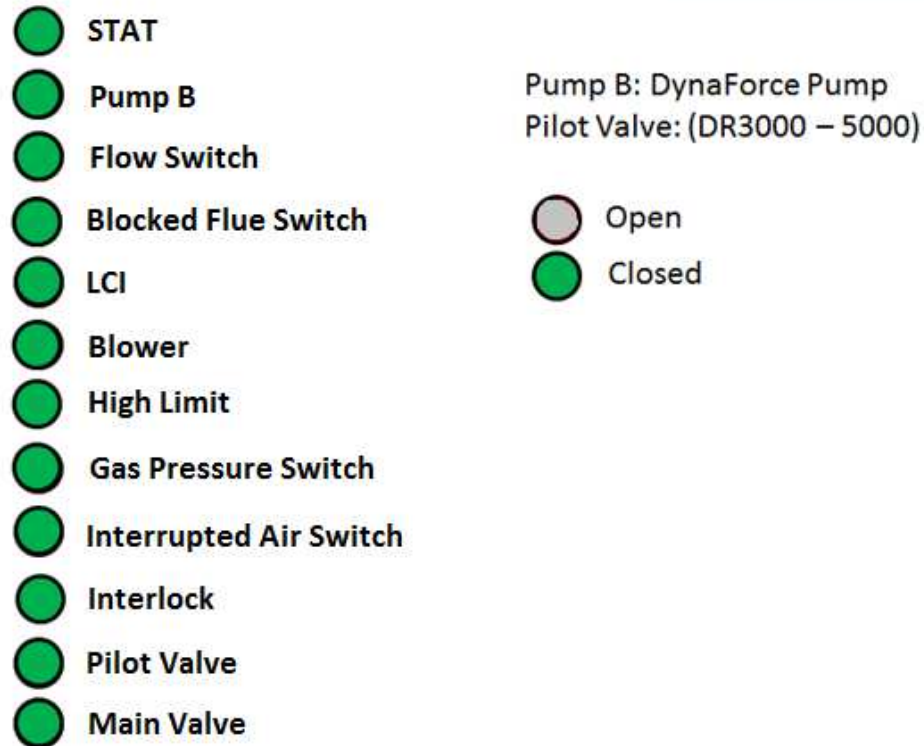

Flow Switch = Flow Switch, Low water cutoff (if equipped), Water Pressure Switch (30 PSI)





Gas Pressure Switch = Low gas pressure switch (4.5" w.c., N/O), High gas pressure switch (14" w.c., N/C)

Blocked flue switch (N/C)

Interrupted Air Switch (DR 1200 – 5000, N/O)

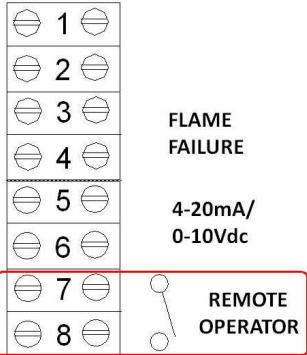
DRH

Modulation: Boiler Inlet, Boiler Fixed Setpoint Operation (Standalone)

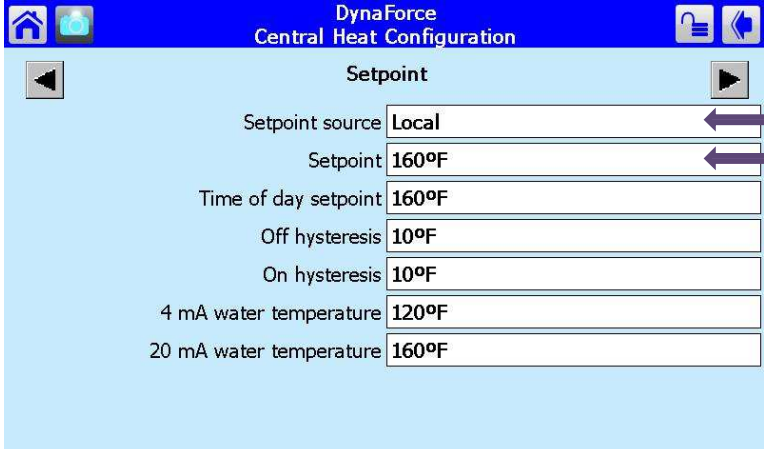
Description	Electrical Connection(s)	Programming Instructions
<ul style="list-style-type: none"> Boiler operates at a fixed setpoint Modulates on boiler inlet sensor (default) Heat demand is generated when Remote Operator is closed. 		<ol style="list-style-type: none"> Place both toggle switches to LOCAL Press  and  Press [CH – Central Heat Configuration] Press the  to arrive at Setpoint Select Setpoint source: Local Enter desired Setpoint Place toggle switch to REMOTE for remote enable operation (if required) 

Modulation: Boiler Inlet, Outdoor Reset Operation (Standalone)

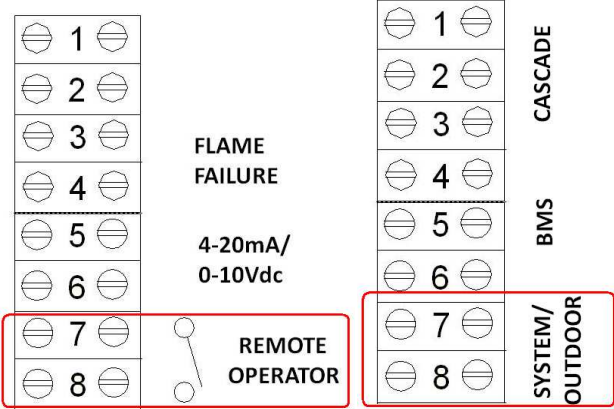
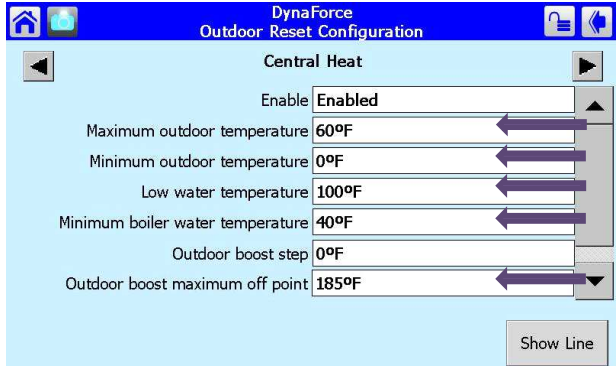
Description	Electrical Connection(s)	Programming Instructions
<ul style="list-style-type: none"> Boiler operates with variable setpoint determined by outdoor reset curve Modulates on inlet sensor (default) Heat demand is generated when Remote Operator is closed. 	 <p>The diagram shows an 8-terminal block. Terminals 1-6 are grouped under 'CASCADE' and 'BMS'. Terminals 7-8 are grouped under 'SYSTEM/OUTDOOR'. Terminal 7 is highlighted with a red box. A red box also highlights the 'REMOTE OPERATOR' label and its associated switch symbol.</p>	<ol style="list-style-type: none"> Connect outdoor sensor to System/Outdoor contacts Press Configure and Login Press Outdoor Reset Configuration Press the ▶ to arrive at Central Heat Select Enable: Enable Select Maximum outdoor temperature (WWSD) Select Minimum outdoor temperature (Outdoor Design) Select Low Water Temperature (Min. Water Temp.) Select Outdoor boost maximum off point (Design Max.) Press [CH – Central Heat Configuration] Press Sensor Configuration Select S5 (J8-11) Sensor Select Connector Type: 10K NTC Single Non-Safety Outdoor temperature source = S5 (J8-11) sensor The control will proceed into a Lockout 2 condition Press [Verify] > [Begin] > [Yes] Press the reset button on the ignition control within the allotted time Place toggle switch to REMOTE for remote operation (if required)  <p>The screenshot shows the 'DynaForce Outdoor Reset Configuration' interface. The 'Central Heat' section is active, showing the following settings:</p> <ul style="list-style-type: none"> Enable: Enabled Maximum outdoor temperature: 60°F Minimum outdoor temperature: 0°F Low water temperature: 100°F Minimum boiler water temperature: 40°F Outdoor boost step: 0°F Outdoor boost maximum off point: 185°F <p>A 'Show Line' button is visible at the bottom right of the interface.</p>

Modulation: System Sensor, Outdoor Reset Operation (Standalone)

NOTE: Outdoor Reset Module (PN: W8735S1000) required.



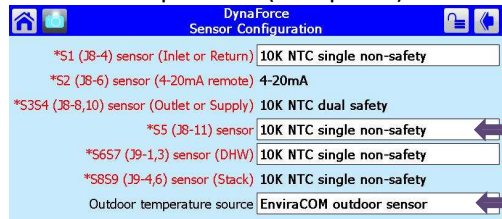

Description	Electrical Connection(s)	Programming Instructions
<ul style="list-style-type: none"> Boiler operates with variable setpoint determined by outdoor reset curve Modulates on system sensor Heat demand is generated when Remote Operator is closed. 	<p>The diagram shows an 8-terminal block. Terminals 1-4 are labeled 'CASCADE', 5-6 'BMS', and 7-8 'SYSTEM/OUTDOOR'. Terminal 3 is labeled 'FLAME FAILURE'. Terminal 5 is labeled '4-20mA/0-10Vdc'. Terminal 7 is labeled 'REMOTE OPERATOR' and has a switch symbol. Terminals 7 and 8 are circled in red.</p>	<ol style="list-style-type: none"> 1) Connect Remote Operator 2) Connect System sensor to System/Outdoor contacts 3) Connect Outdoor Sensor to J3 ECOM connector 4) Place both toggle switches in LOCAL 5) Press and 6) Press Outdoor Reset Configuration 7) Press the to arrive at Central Heat 8) Select Enable: Enable 9) Select Maximum outdoor temperature (WWSD) 10) Select Minimum outdoor temperature (Outdoor Design) 11) Select Low Water Temperature (Min. Water Temp.) 12) Select Outdoor boost maximum off point (Design Max.) <p>The screenshot shows the 'DynaForce Outdoor Reset Configuration' window. Under the 'Central Heat' section, the following settings are visible: <ul style="list-style-type: none"> Enable: Enabled Maximum outdoor temperature: 60°F Minimum outdoor temperature: 0°F Low water temperature: 100°F Minimum boiler water temperature: 40°F Outdoor boost step: 0°F Outdoor boost maximum off point: 185°F A 'Show Line' button is at the bottom right. </p>

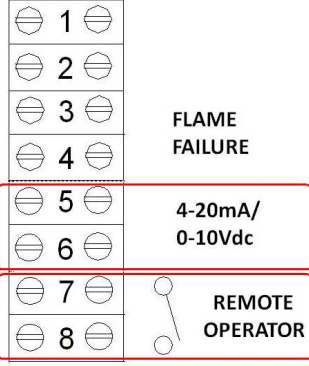
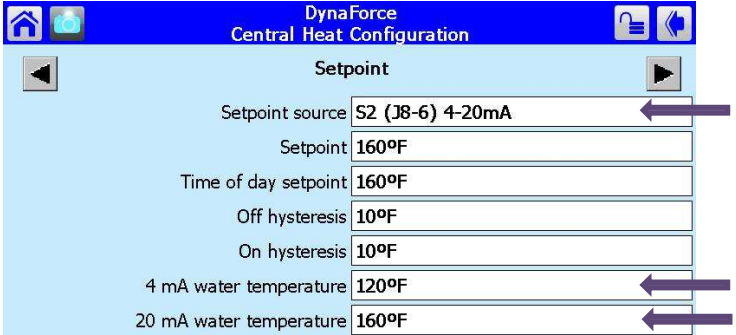
		<p>13) Press [Show Line] to confirm reset curve</p> <p>14) Press Sensor Configuration</p> <p>15) Select S5 (J8-11) sensor: 10K NTC single non-safety</p> <p>16) Select Outdoor temperature source = EnviraCOM outdoor sensor</p> <p>17) Place toggle switch to REMOTE for remote enable operation (if required)</p> 
--	--	--------------------------------------------------------------------------------------------------------------------------------------------------------------------------------------------------------------------------------------------------------------------------------------------------------------------------------------------------------------------------------------------------------------------------------------------

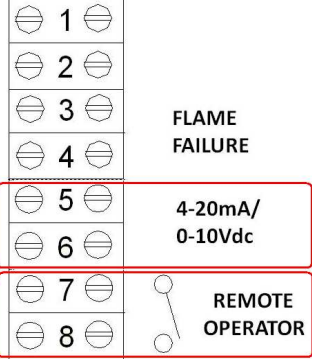

4-20mA/ 2-10Vdc Setpoint Operation (Standalone)

Description	Electrical Connection(s)	Programming Instructions
<ul style="list-style-type: none"> Boiler operates with variable setpoint determined by 4-20mA incoming signal Modulates on boiler inlet sensor (default) Heat demand is generated when Remote Operator is closed and 4-20mA or 2-10Vdc signal is present. 		<ol style="list-style-type: none"> Place both toggle switches in LOCAL Press Configure and Login Press [CH – Central Heat Configuration] Press the ▶ to arrive at Setpoint Select Setpoint Source = S2 (J8-6) 4-20mA Select 4mA water temperature Select 20mA water temperature Place toggle switch to REMOTE for remote operation (if required) 

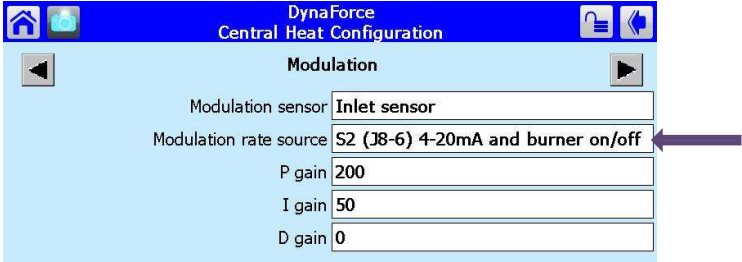
4-20mA/ 2-10Vdc Firing Rate Operation (Standalone)



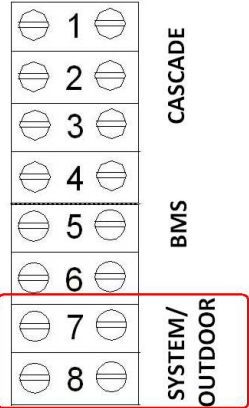

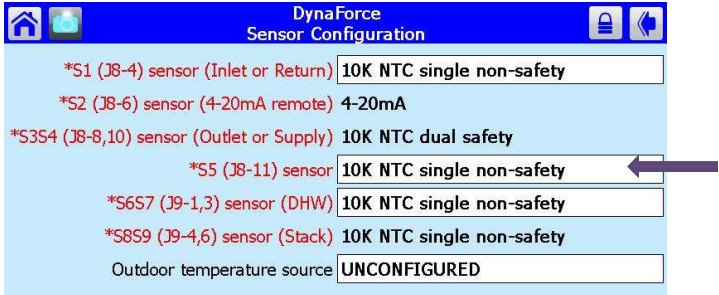
Description	Electrical Connection(s)	Programming Instructions
<ul style="list-style-type: none"> Boiler operates with variable setpoint determined by 4-20mA incoming signal Modulates on header sensor Heat demand is generated when Remote Operator is closed and 4-20mA or 2-10Vdc signal is present. 		<ol style="list-style-type: none"> Place both toggle switches in LOCAL Press  and  Press [Lead Lag Master Configuration] Press [Advanced Settings >] Press the  to arrive at Central Heat Select Modulation rate source = S2 (J8-6) 4-20mA and burner on/off Place toggle switch to REMOTE for remote operation (if required) 

System Sensor Enable (Standalone)

Description	Electrical Connection(s)	Programming Instructions
<ul style="list-style-type: none"> Method to enable system sensor for Standalone applications 		<ol style="list-style-type: none"> Press  and  Press [Sensor Configuration] Select S5 (J8-11) Sensor: 10K NTC Single Non-Safety The control will proceed into a Lockout 2 condition Press [Verify] > [Begin] > [Yes] Press the reset button on the ignition control within the allotted time 

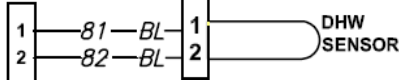
DRW

Modulation: Fixed Setpoint Operation (Standalone)

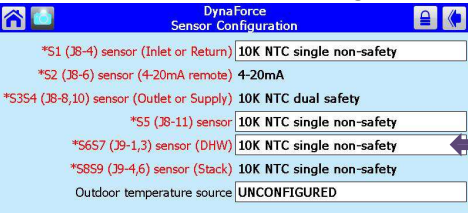
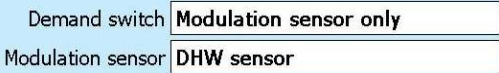
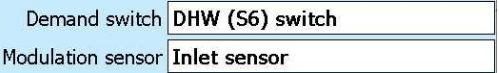



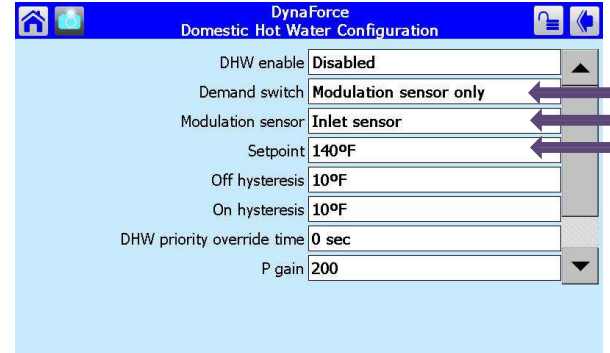

Description	Electrical Connection(s)	Programming Instructions
<ul style="list-style-type: none"> Boiler operates at a fixed DHW setpoint Modulates on boiler inlet sensor (default) Heat demand is generated when Remote Operator is closed. 	<p>DHW Sensor/ Stat, if required.</p> 	<ol style="list-style-type: none"> Place both toggle switches to LOCAL Press  and  <p><u>Inlet Sensor operation</u></p> <ol style="list-style-type: none"> Press [DHW – Domestic Hot Water Configuration] Select Demand Switch: Modulation sensor only Select Modulation sensor: Inlet Sensor. Proceed to Step 12  <p><u>DHW Sensor/Stat operation</u></p> <ol style="list-style-type: none"> Press [Sensor Configuration] Select S6S7 (J9-1,3) Sensor (DHW): 10K NTC Single Non-Safety The control will proceed into a Lockout 2 condition Press [Verify] > [Begin] > [Yes] Press the reset button on the ignition control within the allotted time  <p><u>DHW Sensor operation</u></p> <ol style="list-style-type: none"> Press [DHW – Domestic Hot Water Configuration] Select Demand Switch: Modulation sensor only Select Modulation sensor: DHW Sensor. Proceed to Step 12  <p><u>DHW Stat operation</u></p> <ol style="list-style-type: none"> Press [DHW – Domestic Hot Water Configuration] Select Demand Switch: Modulation sensor only Select Modulation sensor: DHW (S6) switch & inlet sensor  <ol style="list-style-type: none"> Enter desired Setpoint

13) Place toggle switch setting to **REMOTE** for remote operation (if required)

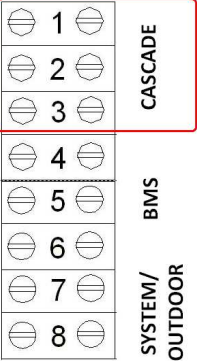

DR(H,W) Lead lag Operation

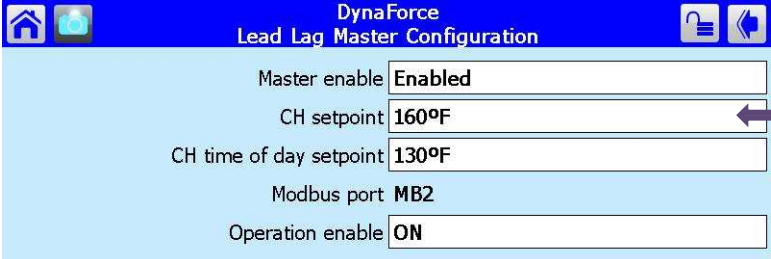
Master Boiler

Description	Electrical Connection(s)	Programming Instructions
<ul style="list-style-type: none"> Master boiler lead lag setup 		<ol style="list-style-type: none"> Place both toggle switches to LOCAL Press  and  Select System Identification & Access Verify MB1 Modbus address = 1 Verify MB2 Modbus address = 1  <ol style="list-style-type: none"> Select Lead Lag Master Configuration Select Master Enabled = Enabled <u>Fixed Setpoint operation</u> Enter CH Setpoint (Fixed setpoint)  <ol style="list-style-type: none"> <u>4-20mA/ 0-10Vdc setpoint operation</u> Select [Advanced Settings >] Press the  to arrive at Central Heat Select Setpoint Source = S2 (J8-6) 4-20mA Select 4mA water temperature

13) Select **20mA water temperature**

DynaForce Lead Lag Master Configuration	
Central Heat	
Demand switch	STAT terminal
Setpoint source	S2 (J8-6) 4-20mA
Setpoint	160°F
Time of day setpoint	130°F
4 mA water temperature	100°F
20 mA water temperature	160°F





14) Select **Lead Lag Slave Configuration**15) Select **Slave enabled = Enable slave for built-in Lead Lag master**

DynaForce Lead Lag Slave Configuration	
Slave enable	Enable slave for built-in Lead Lag master
Slave mode	Equalize run time
Slave sequence order	0
Demand to firing delay	10 mins
Fan rate during off cycle	0%
Modbus port	MB2
Modbus address	2

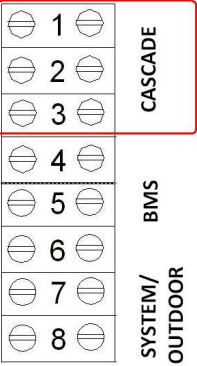

The following steps are performed at the factory and verifying on site will be sufficient:

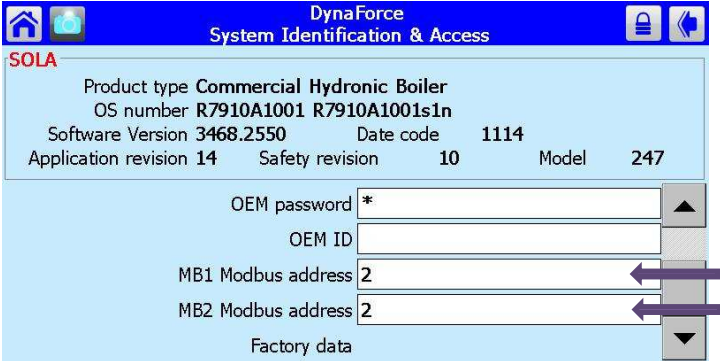
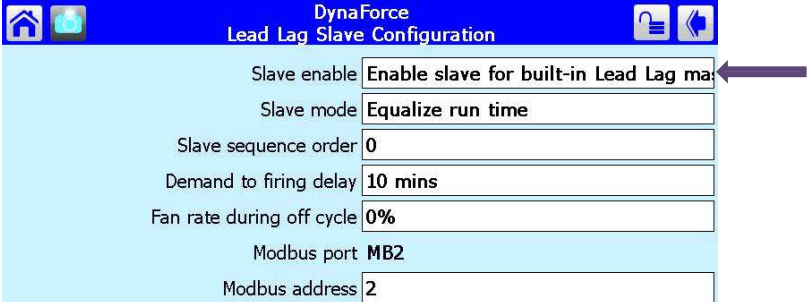
16) Select **Pump Configuration**17) Press **[Advanced Options >>]**18) Press the **▶** to arrive at **Central Heat Pump** or **DHW Pump**19) On Options: Local burner demand20) On Options: Local Lead Lag Service Active21) Force On: Outlet high limit

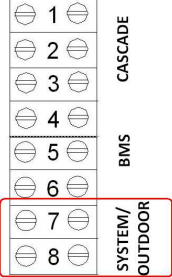

Slave Boiler

Description	Electrical Connection(s)	Programming Instructions
<ul style="list-style-type: none"> Slave boiler lead lag setup 		<ol style="list-style-type: none"> Place both toggle switches to LOCAL Press  and  Select System Identification & Access Verify Modbus address. To be in sequential order  Select Lead Lag Slave Configuration Select Slave Enabled = Enable slave for built-in Lead Lag master  <p>The following steps are performed at the factory and verifying on site will be sufficient:</p> <ol style="list-style-type: none"> Select Pump Configuration Press [Advanced Options >>] Press the  to arrive at Central Heat Pump or DHW Pump On Options: <input checked="" type="checkbox"/> Local burner demand On Options: Local Lead Lag <input checked="" type="checkbox"/> Service Active Force On: <input checked="" type="checkbox"/> Outlet high limit

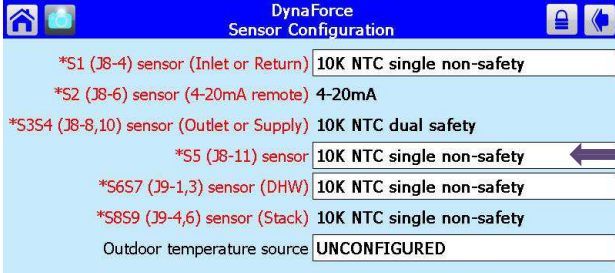

Master Boiler, System Sensor

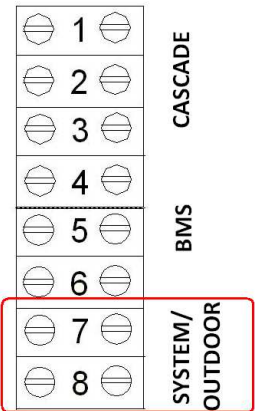
Description	Electrical Connection(s)	Programming Instructions
<ul style="list-style-type: none"> Master boiler system sensor configuration 		<ol style="list-style-type: none"> Press  and  Press [Sensor Configuration] Select S5 (J8-11) Sensor Connector Type: 10K NTC Single Non-Safety  <ol style="list-style-type: none"> The control will proceed into a Lockout 2 condition Press [Verify] > [Begin] > [Yes] Press the reset button on the ignition control within the allotted time

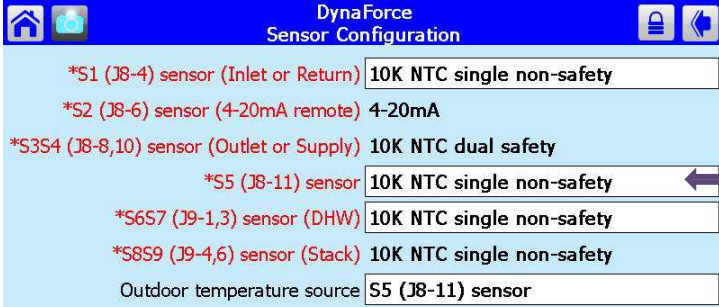
Outdoor Sensor connected to Slave boiler 2 (DRH ONLY)

Description	Electrical Connection(s)	Programming Instructions
<ul style="list-style-type: none"> Slave boiler outdoor sensor configuration When done correctly, the outdoor temperature will be shown on the Master boiler 		<p><u>Slave Boiler</u></p> <ol style="list-style-type: none"> Press  and  Press [Sensor Configuration] Select S5 (J8-11) Sensor Connector Type: 10K NTC Single Non-Safety  <ol style="list-style-type: none"> The control will proceed into a Lockout 2 condition Press [Verify] > [Begin] > [Yes]

7) Press the reset button on the ignition control within the allotted time
Master Boiler

8) Press  and 

9) Press [**Lead Lag Master Configuration**]

10) Press [**Advanced Settings >**]

11) Press the  to arrive at **Outdoor Reset**

12) Select **Enable: Enabled**

13) Select **Maximum outdoor temperature (WWSD)**

14) Select **Minimum outdoor temperature (Outdoor Design)**

15) Select **Low Water Temperature (Min. Water Temp)**

16) Select **Outdoor boost maximum off point (Design Max.)**

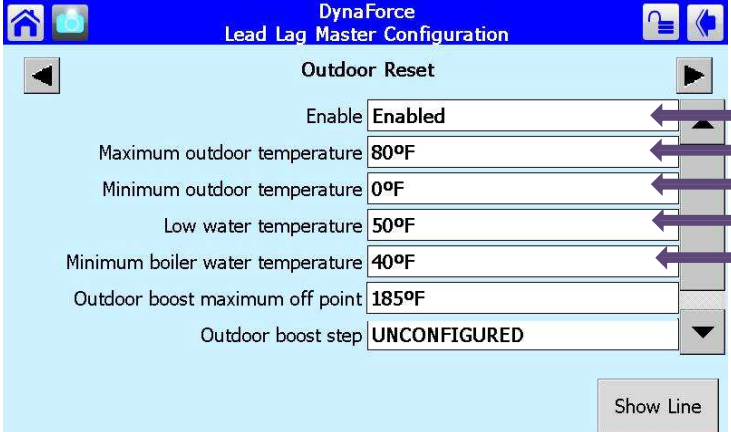

The screenshot shows the 'Outdoor Reset' configuration screen. The title bar reads 'DynaForce Lead Lag Master Configuration'. The screen contains the following settings:

Parameter	Value
Enable	Enabled
Maximum outdoor temperature	80°F
Minimum outdoor temperature	0°F
Low water temperature	50°F
Minimum boiler water temperature	40°F
Outdoor boost maximum off point	185°F
Outdoor boost step	UNCONFIGURED

A 'Show Line' button is located at the bottom right of the screen.

17) Press [**Show Line**] to confirm reset curve

18) Press the  to arrive at **Warm Weather Shutdown**

19) Select **Enable = Shutdown after demand ends**



The screenshot shows the 'Warm Weather Shutdown' configuration screen. The title bar reads 'DynaForce Lead Lag Master Configuration'. The screen contains the following settings:

Parameter	Value
Enable	Shutdown after demand ends
Setpoint	60°F

Rotation schedule adjustment

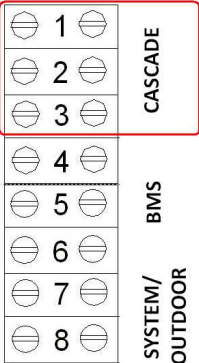
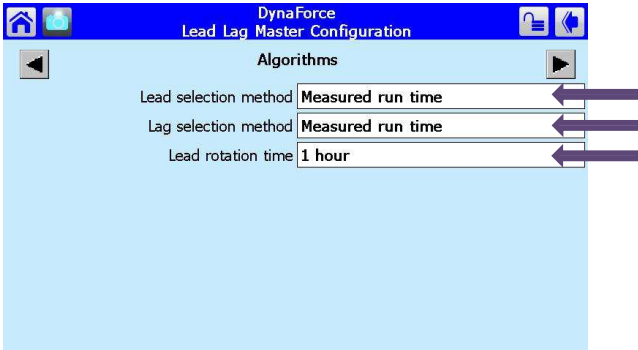
Description	Electrical Connection(s)	Programming Instructions
<ul style="list-style-type: none"> Standard rotation schedule is based on equalizing run time on a 1-hour schedule To vary the rotation to a fixed schedule based on (hours, days) 		<ol style="list-style-type: none"> Press Configure and Login Press [Lead Lag Master Configuration] Press [Advanced Settings >] Press the ▶ to arrive at Algorithms Select Lead selection method: Sequence order Select Lag selection method: Sequence order Select Lead rotation time: (user defined) 

Base load rate adjustment

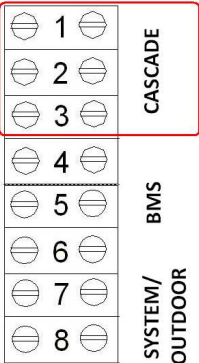
Description	Electrical Connection(s)	Programming Instructions
<ul style="list-style-type: none"> Upon a call for heat the lead boiler will fire to the specified base load rate (80%). If the temperature is not within Error threshold (5°F) of setpoint after Interstage delay (2 minutes) a lag boiler will be brought online and will also fire at the base load rate specified. Modulation of boilers will only occur after all boilers in the Lead Lag system are firing at the specified base load 		<ol style="list-style-type: none"> Press Configure and Login Press [Lead Lag Master Configuration] Press [Advanced Settings >] Press the ▶ to arrive at Rate Allocation Select Base load common: (user defined)

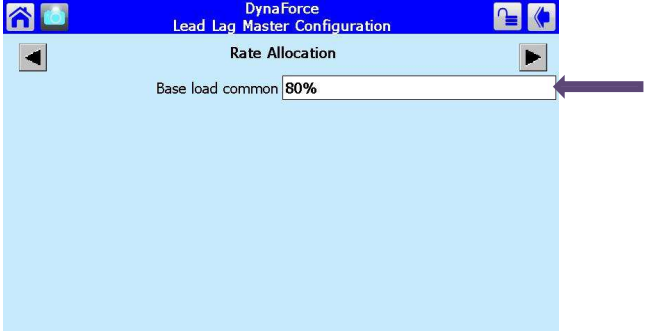
rate (80%).		
-------------	--	-------------------------------------------------------------------------------------

Adjust staging of boilers

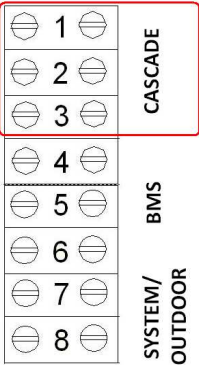
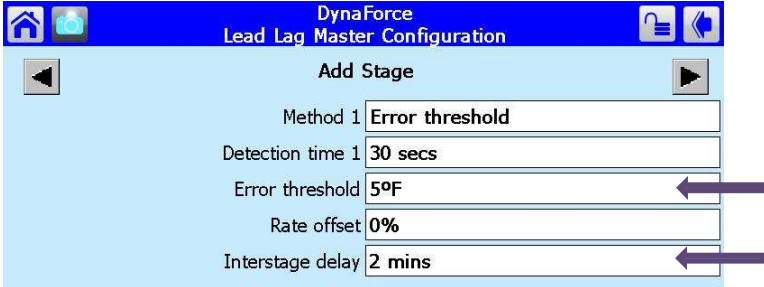
Description	Electrical Connection(s)	Programming Instructions
<ul style="list-style-type: none"> Upon a call for heat the lead boiler will fire up to the specified base load rate (80%). If the temperature is not within Error threshold (5°F) of setpoint after Interstage delay (2 minutes) a lag boiler will be brought online and will also fire up to the base load rate specified. This method will then be repeated for the next lag boiler, if available. 		<ol style="list-style-type: none"> 1) Press Configure and Login 2) Press [Lead Lag Master Configuration] 3) Press [Advanced Settings >] 4) Press the ▶ to arrive at Add Stage 5) Select Error threshold 6) Select Interstage delay 

6.2.2 Pump Configuration

6.2 CONFIGURE MENU

Figure 26: Configure Menu

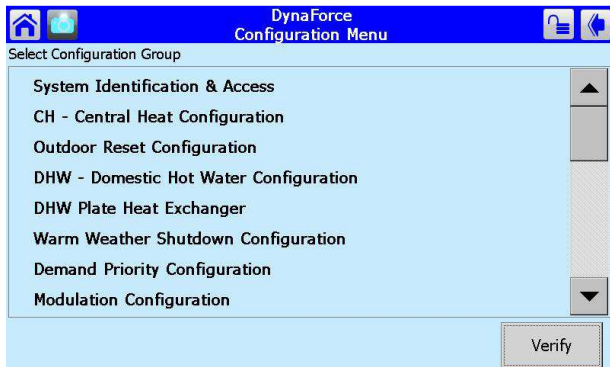

6.2.1 System Identification & Access

Menu Group Selection	Parameter	Description
System Identification & Access	Product Type	Commercial Hydronic Boiler
	OS number	Part Number of SOLA Controller
	Software Version	Software version
	Date Code:	Release date of software
	Boiler Name	Dynaforce® Model Number
	Installation	Type of application

Menu Group Selection	Sub-Menu Group Selection	Parameter	Selection	Description
Pump Configuration	Central Heat Pump	Pump Control	Auto	Assigns the method for SOLA to control a Central Heating pump (Default: Auto, Pump is activated whenever a call for heat is present)
			ON	ON: Pump is constantly powered
		Pump Output	Pump B	Specify pump contact
		Over run time	1..5 min	Post pump time (Default: 1 min)
		Use for local (Stand-alone) demands	✓	
		Use for Lead Lag Master demands	✓	
	Boiler Pump	Pump Control	Auto	Refer to above (Default)
			ON	Refer to above
		Pump Output	Pump A	Specify pump contact
		Over run time	1.5 min	Post pump time (Default: 1 min)
		Use for local (Stand-alone) demands	✓	
		Use for Lead Lag Master demands	✓	
Pump Configuration	DHW Pump	Pump Control	Auto	Refer to above (Default)
			ON	ON: Pump is constantly powered
		Pump Output	Pump B	Specify pump contact
	System Pump	Pump Control	Auto	Refer to above (Default)
			ON	ON: Pump is constantly powered
		Pump Output	None	Specify pump contact
Over run time	1..5 min	Post pump time (Default: 1 min)		

6.2.3 Statistics Configuration

Menu Group Selection	Sub-Menu Group Selection	Parameter	Selection	Description
		Boiler pump cycles		Displays the number of cycles the boiler pump has been activated
		Burner cycles		Displays the number of cycles the burner has been activated
		Burner run time		Displays burner run time in hours
		CH pump cycles		Displays the number of cycles the CH pump has been activated
		DHW pump cycles		Displays the number of cycles the DHW pump has been activated
		System pump cycles		Displays the number of cycles the system pump has been activated

6.2.4 Burner Control Timing and Rates

Figure 27: Burner Control Timing and Rates

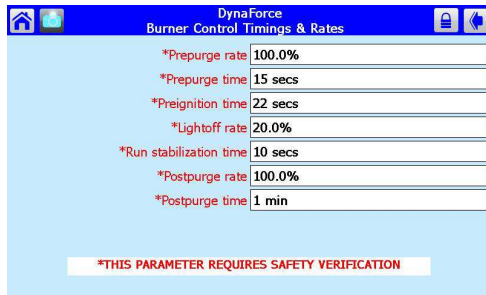

Menu Group Selection	Sub-Menu Group Selection	Parameter	Selection	Description
Burner Control Timing and Rates		Prepurge rate	3000 RPM	Prepurge fan speed (Default: DR300 – 1000: 3000 RPM, DR1200 – 5000: 100.0%)
		Prepurge time	25 sec.. 5 mins	Prepurge time (Default: 25 sec)
		Run Stabilization Time	10 sec	Main flame establishing period
		Postpurge rate	3000 RPM	Postpurge fan speed (Default: DR300 – 1000: 3000 RPM, DR1200 – 5000: 100.0%)
		Postpurge time	25 sec.. 5 mins	Postpurge time (Default 25 sec)

6.2.5 Burner Control Ignition

Menu Group Selection	Sub-Menu Group Selection	Parameter	Selection	Description
Burner Control Ignition		Lightoff rate	DR300-1000: 3000 RPM DR1200 – 5000: 20.0%	Ignition Fan speed

6.2.6 Sensor Configuration

Menu Group Selection	Sub-Menu Group Selection	Parameter	Selection	Description
Sensor Configurations		S1 (J8-4) sensor	10K NTC single non-safety	Inlet Sensor
		S2 (J8-6) sensor	4-20mA	4-20mA Input Signal
		S3S4 (J8-8, 10) sensor	10K NTC dual safety	Outlet Sensor
		S5 (J8-11) sensor	10K NTC single non-safety	Outdoor Sensor: Standalone boiler or Slave boiler Header sensor: Master boiler
		S6S7 (J9-1,3) sensor	10K NTC single non-safety	DHW Sensor (DRW Only)
		S8S9 (J9-4,6) sensor	10K NTC single non-safety	Stack Sensor

6.3 LEAD LAG SETUP UP TO 8 BOILERS

The following components are needed for a Lead Lag setup

- 1) 10kΩ System Sensor

Turn off all the boilers before beginning the setup process.

To setup the Dynaforce® Lead Lag system follow the instructions:

System Sensor

Insert the supplied 10kΩ system sensor into the building loop. The wires coming out of the system sensor should be connected to Sys/Outdr terminals in the junction box.

NOTE

The use of a system sensor is required in lead lag operation.

- 1) When variable speed main circulators **ARE NOT** used the system sensor is to be placed into the return system piping.
- 2) When variable speed main circulators are used the system sensor is to be placed into the supply system piping.

All SOLA controllers are programmed with a default address of 1. The address of the slave controllers in the system must have a unique address (1..8).

Sequence of Operation:

When a boiler is set as Lead Lag Master = Enabled and Modbus address = 1, the controller of this boiler will drive the lead lag operation.

The outdoor temperature sensor connected to the slave boiler 2 (ie. B-2) will be the outdoor sensor for the lead lag system

- The system temperature sensor connected to boiler 1 (the master) in terminals labeled “Outdr/Sys” in the junction box will be the control sensor for lead lag operation.
- The start/stop signal connected to boiler 1 (the master) at terminals labeled “Remote Operator” will be the heat demand input for lead lag operation.

When demand for heat is present the lead boiler will start and uses the lead lag parameters for boiler modulation. After a period of “Interstage delay” the master boiler compares the lead lag temperature with the lead lag set point and will check if:

- 1) **An additional boiler is needed**
Lead lag temp < Lead lag setpoint – Add stage Error threshold
- 2) **Number of boilers remain the same**
Lead lag > Lead lag setpoint – Add stage Error threshold **AND**
Lead lag temp < Lead lag setpoint + Drop stage Error threshold
- 3) **A boiler should stop**
Lead lag temp > Lead lag setpoint + Drop stage Error threshold
- 4) **All boilers off**
Lead lag temp > Lead lag setpoint + off hysteresis

If the lead lag master system is interrupted the remaining boilers will operate as standalone boilers based on the Central Heat or DHW parameters when set to “Enabled”.

Rotation

Rotation time is configurable based on equalized run time (default) or a fixed rotation schedule.

Interstage Delay

The length of time to wait between starting the next boiler in sequence. (Default: 2 minutes)

Base Load Rate

When a call for heat is initiated the lead boiler runs up to the desired base load rate (Default: 80%) and continues to operate in this fashion based on the above 4 scenarios. If the lead lag temperature is not satisfied a second boiler is fired and they would both operate up to 80% fire rate.

Slave State

Slave Status Manager	
Unknown	Table entry is unused or empty
Available	Slave is operational and ready to use
Add Stage	Stage is getting ready to fire
Suspend Stage	Stage was getting ready but is not needed
Disabled	Slave is locked out or disabled
Recovering	Slave is in time delay to verify that it is operational before considered to be available

Wiring the Lead Lag Setup

Use Cascade terminals in the junction box to wire lead lag appliances

	Master	Slave 2	..	Slave 7
J3, MB2	A	A	..	A
	B	B	..	B
	C	C	..	C

Figure 28: Lead lag Wiring Setup (Left: Master, Right: Slave)

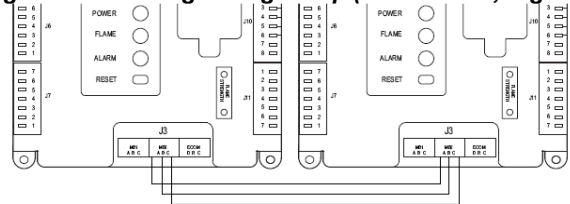

NOTE

Recycle power on all boilers after programming is complete if lag boilers are not discovered automatically

NOTE

CH Setpoint or DHW Setpoint must match Setpoint located in Lead Lag Master Configuration in order for the system to operate correctly.

NOTE

The Local/Remote switch (explained below) must be set in the “Local” position on ALL lag boilers.

6.4 LEAD LAG SETUP FOR UP TO 12 APPLIANCES

Honeywell SOLA can only support up to 8 boilers in a single lead lag network, to sequence a second network of up to 12 boilers in total this will be activated through Pump C contact of boiler #8.

Pump C is activated on a time delay algorithm where the timer is initiated when boiler #8 begins the ignition sequence. The delay timer is set based on the number of boilers in network #1.

Pump C Delay Timer (Register #293) = Interstage Delay (Default: 2 mins) x Number of Boilers. This delay timer will allow all boilers in network 1 to perform an ignition attempt before network 2 is initiated.

Due to the rotation of leaders in network 1; boiler #8 may become lead boiler. Operation is not impacted regardless of lead boiler in network 1 as all boilers in network 1 will attempt to start before network #2 is initiated.

Network 2 operates independently of network 1 and as a result the setpoint for network 2 is recommended to be set at least 2°F lower than network 1. A staggered setpoint approach will reduce the amount of short cycling when all the boilers are viewed as a complete system.

Network 2 can support up to a maximum of 4 boilers.

9 Boiler Outdoor Reset Wiring

The use of outdoor reset requires two outdoor sensors for this setup. Network 1 outdoor sensor is wired to boiler #2 and the outdoor sensor for boiler #9 requires the use of the outdoor sensor module (PN: W8735S1000) wired to the ECOM connection on the Honeywell SOLA.

Additional details can be found on page 76.

10 to 12 Boiler Outdoor Reset Wiring

The use of outdoor reset requires two outdoor sensors for this setup. Network 1 outdoor sensor is wired to boiler #2 and the outdoor sensor for network 2 is wired to boiler #10 on the System/OutD contacts in the junction box.

Additional details can be found on page 77.

6.5 LOCAL/REMOTE SWITCH

The local remote switch mounted inside the control box is designed to deliver an enable signal either relying on an external contact closure (Remote) or enabling the boiler locally (local). When Remote is selected via the SPDT switch the Remote Operator contacts in the junction box must be closed to deliver an enable signal. When Local is selected via the SPDT switch a constant enable signal is present. When troubleshooting the Dynaforce® it is recommended to switch to Local mode.

6.6 COMM. PORT 2 ACTIVATION

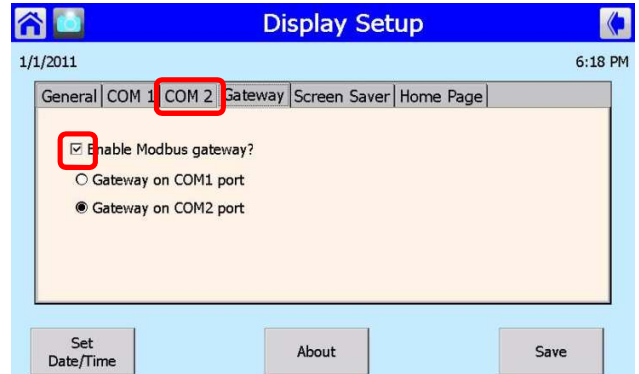
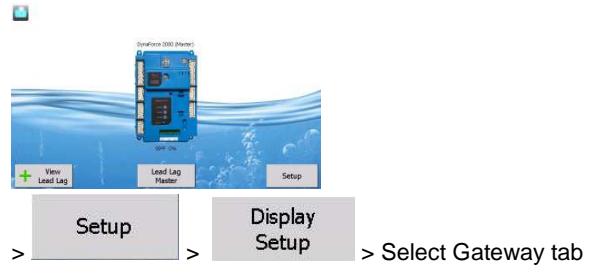

- 1) Select Gateway tab
- 2) Check Enable Modbus gateway
- 3) Select Gateway on COM2 port

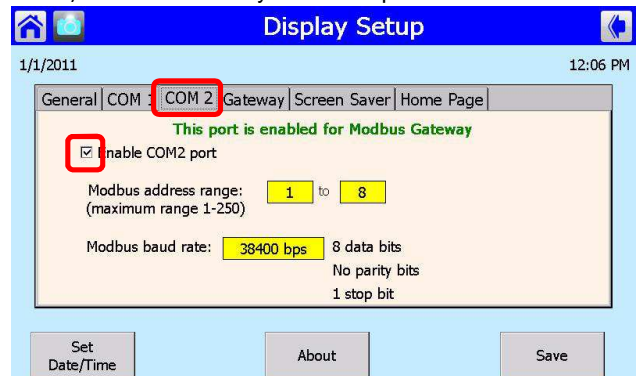

- 1) Select COM2 tab
- 2) Check Enable COM2 port



Verify activity on COM2 port



Display Diagnostics

Version: 1.3 Memory: 16.3MB out of 38.4MB available Build: 73

USB Status: **NOT FOUND**

COM	Status	Bytes	Packets	Rate (bps)	Action
COM 1	Enabled				Clear
Receive:	●	412262	23358	4512	
Transmit:	●	186918	23365	1920	Pause
COM 2	Enabled				Clear
Receive:	●	44475	5555	576	
Transmit:	●	47146	5534	912	Pause

Calibrate Screen Audio Test Video Test Screen Snapshot Display Reset

COM1: Modbus data between display and SOLA
 COM2: Modbus data between display and front end (Modbus) or Protonode

For more instructions on interfacing with Modbus/ Bacnet/ LonWorks/ Metasys N2 network:



http://www.camus-hydrionics.com/Downloads/93_0238_DynaFlame_DynaForce_DynaMaxHS_Advantus_Protocol_Setup.pdf

6.6 VARIABLE FREQUENCY DRIVE (DR1200 - 5000)

The variable frequency drive (VFD) has a factory set security code which has to be entered before any adjustments can be made. The VFD has 50 parameters, which can be adjusted. At present only the following are pertinent:

Table 13: Variable Frequency Drive Parameters

Parameter #	Function	Settings
1	High/Low Voltage Input Voltage 120, 220-240, 460-480	01 02
2	Carrier Frequency	03
4	Stop Method	03
5	Standard Speed Source	04
19	Acceleration Time	120 sec
20	Deceleration Time	60 sec
28	Fixed Boost	1.0
36	Preset Speed	29
38	Skip Bandwidth	3.0
45	Speed at Minimum Signal	Consult factory test sticker
46	Speed at Maximum Signal	Consult factory test sticker
50	Fault History	View Only
51 thru 58	Miscellaneous	View Only

6.7 FROST PROTECTION

The Dynaforce® is equipped with a heat exchanger frost protection algorithm where if the boiler inlet or outlet temperature sensors drop below 41°F (5°C) the boiler pump is enabled. If the temperature continues to drop to 38°F (3.3°C) the burner will be fired to bring the inlet and outlet temperatures to 50°F (10°C) to prevent freezing of the heat exchanger.

PART 7 COMPONENTS

7.1 HOT SURFACE IGNITER (GLOW BAR)

The silicon carbide igniter is inserted directly through the fan flange and held in place by two screws. A hold down bracket as well as sealing gasket above and below the igniter assures a good seal. Care must be taken when removing and/or installing the igniter since the silicon carbide element is brittle. Always remove the igniter prior to removing the fan assembly for inspection of the burner and heat exchanger. A properly prepared igniter will have a bead of silicone sealing the end mounting bracket to the ceramic shaft.

Figure 29: Hot Surface Igniter

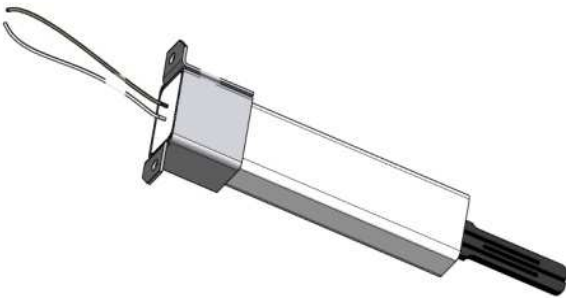

During trial for ignition a properly operating igniter will generate a minimum $3.2 \pm 0.2A$ which is the current required for reliable ignition. It is recommended that the hot surface igniter be replaced every 4,000 hours of appliance operation to maintain peak ignition efficiency.

7.2 FLAME SENSOR

The flame sensor is inserted directly through the fan flange and is screwed into the fan flange. Care must be taken, when installing the flame sensor, to align it perpendicular to the fan flange and parallel to the burner tube and not to over tighten. Always remove the flame sensor prior to removing the fan assembly for inspection of the burner and heat exchanger.

Figure 30: Flame Sensor

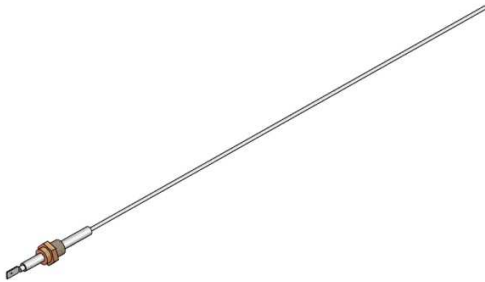

The ignition module relies on the flame sensor to provide a flame rectification signal. Oxide deposits, improper placement or damaged ceramic insulator will result in insufficient signal leading to ignition module lock out. For proper operation minimum 0.8 Vdc must be fed back to the module. Oxide deposit on the sensor rod must be removed with steel-wool. Do not use sand-paper since this will contaminate the surface.

7.3 COMBUSTION AIR FAN

DR300 – 1000

Uses a modulating air fan to provide combustible air/gas mix to the burner and push the products of combustion through the heat exchanger and venting system. The fan assembly consists of a sealed housing and fan wheel constructed from spark resistant material. The fan is operated by a fully enclosed 120 VAC, Single-Phase EC/DC electric motor. The fan housing and motor assembly is fully sealed and SHOULD NOT be field serviced. The power draw of the motor is proportional to the modulated gas input rate of the appliance.

DR 1200 - 5000

Figure 31: Fan, Burner, Hot Surface Igniter and Flame Sensor Arrangement (DR 1200 – 5000)

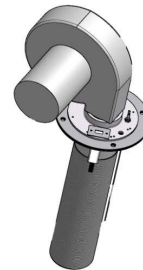

Uses a sealed air fan to provide combustible air/gas mix to the burner and push the products of combustion through the heat exchanger and venting system. The fan assembly consists of a sealed housing and fan wheel constructed from spark resistant cast aluminum. The fan is operated by a fully enclosed 230 VAC, 3 Phase electric motor. The fan housing and motor assembly is fully sealed and SHOULD NOT be field serviced. The power draw of the motor is proportional to the modulated gas input rate of the appliance.

7.4 INNER JACKET

The inner jacket assembly is constructed from a special corrosion resistant stainless steel. All screws, bolts, nuts and fasteners used for assembly of the inner jacket are also stainless steel.

DO NOT mix stainless steel and standard plated fasteners when disassembling and reassembling the inner jacket sheet metal components. Standard plated fasteners will be damaged by the flue product condensate when used on the inner jacket assemblies.

7.5 OUTER JACKET

The outer jacket assembly is constructed from mirror finish stainless steel. This ensures a long life for the jacket assembly, with full integrity

7.6 VENTING TRANSITION

All appliances are shipped with a round stainless steel adapter. Depending on the appliance category an increaser will be required for the proper vent configuration. Please refer to Table 3 dimensions and specifications. When installing Category II or IV appliances care must be taken to properly seal all joints and provide slope for drainage of condensate away from the boiler.

PART 8 FIELD STARTUP PROCEDURE

8.3 GAS VALVE ADJUSTMENT PROCEDURE

Table 14: Combustion Values

Dynaforce® Combustion Values				
	Natural Gas		Propane	
	CO ₂	CO	CO ₂	CO
Max. Fire	8.5% - 9.0%	<100 PPM	9.5% - 10.0%	<100 PPM
Min. Fire	8.0% - 8.5%	<100 PPM	9.0% - 9.5%	<100 PPM

8.1 CHECKING THE INSTALLATION

- Inspect the connections for water, gas and electricity.
- Confirm that water is being pumped toward the heat exchanger inlet. Never pump away from the exchanger since this will result in a low-pressure zone, which will allow localized boiling and result in heat exchanger damage.
- Power to the boiler and pump must be from the same circuit to prevent the boiler firing in case the pump is inadvertently shut off.
- Inlet gas pressure must be a minimum of 3" W.C. for natural gas and 11" W.C. for propane.
- With the boiler off, open the main gas supply valve and vent the trapped air from the piping leading to the boiler. Confirm that all gas connections to the heater are tight and that there are no missing test plugs.
- **DR2000 – 5000:** Connect a manometer to obtain the differential air pressure between negative and positive ports, see Figure 10.
- The air/gas ratio controller automatically adjusts to match the air signal on the gas side. In this way true mass flow control of air/gas mix is achieved. All boilers are test fired and factory set. A test sticker with actual reading is affixed to the unit.

8.2 CHECKING THE CONSTRUCTION

- Check the boiler wiring to see that it agrees with the wiring diagram supplied.
- Confirm that all terminal strips and field connections are identified.
- Confirm that the Dynaforce® controller is set in the proper mode. Auto reset limits are fixed in all modes.
- With the firing valve in the off position, switch on power to the boiler. The fan motor will accelerate until the airflow icon becomes green.
- Once all lights past the STAT are green the SOLA will try for ignition. When the igniter is hot enough, the gas valve actuator is energized and if ignition is accomplished the Burner State will show "Run". If ignition is not accomplished, the Burner State will show "Safe Startup" and two more ignition trials will be made 15 seconds apart. The control will then proceed to lockout and must be reset by momentarily interrupting power. It is normal during initial start up, when air is being purged from the piping, to require two to three tries before successful ignition.
- With the boiler running, check for flue gas leaks along the inner cabinet joints and around the flue outlet.
- Repair any leaks prior to the next step.
- At the factory adjustments were made to achieve proper input and acceptable burner performance at full input and at minimum input.
- Depending on field conditions, the CO₂ metering valve may require some minor adjustment at full input. Refer to Table 14. Adjustment at minimum input can be done at the low fire adjustment screw by first removing the brass cap. Turning adjustment screw clockwise will increase CO₂.

If adjustment of the gas valve is required use the following procedure.

It is imperative that the coldest system water temperature possible is used when setting up low fire combustion. These cold system temperatures create large amounts of flue condensate resulting in large amounts of condensate build up on the stainless steel finned heat transfer tubes. These conditions create the highest back pressure through the boiler and makes for the most critical combustion set up point when running 20% input. This set up must be achieved quickly to ensure low system temperatures are maintained throughout the set up of single or multiple boiler installations.

Light off the boiler at low fire and make the initial adjustment to the low fire bias to obtain the specified CO₂, CO, at 20% gas input.

While maintaining the lowest possible water temperature, observe the differential gas pressure. The differential gas pressure must not drop below a minimum of 0.25" w.c. If necessary increase the VFD (Hz) setting until this pressure is met. Once the boiler has run for at least 10-15 minutes with dead cold water, there should be a maximum amount of condensate in the lower heat exchanger. At this point adjust the combustion for CO₂.

The boiler must continue to run with stable combustion without making any howling noise which usually happens from an overly rich mixture. Once settings are complete at low fire, continue to run the machine for at least 10-15 more minutes and record the final low fire input and the combustion data.

To ensure the coldest possible water temperatures for set up on multiple boiler systems, the low fire combustion should be established on all boilers before setting any boiler high fire combustion rates.

In order to perform adjustments to the gas valve the Dynaforce® must be firing before proceeding.

Figure 32: DR 300 – 400 Gas Valve

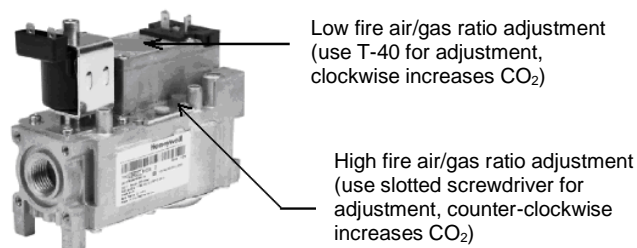
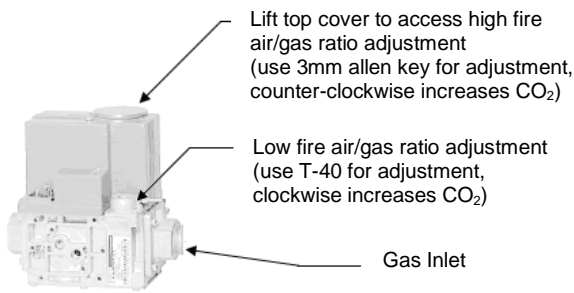

Figure 33: DR 500 - 1800 Gas Valve



Lift top cover to access high fire air/gas ratio adjustment (use 3mm allen key for adjustment, counter-clockwise increases CO₂)

Low fire air/gas ratio adjustment (use T-40 for adjustment, clockwise increases CO₂)

Gas Inlet

To adjust the low fire setting (DR 300 – 1800)

Use the Dynaforce® Control Panel:

- 1) Press **[DIAGNOSTICS]** button
- 2) Press **[Diagnostic Tests]** button
- 3) Move the firing rate slider to 1600 RPM
- 4) Press **[Start Test]** to operate the boiler at max fire for 5 minutes.

The Dynaforce® should respond immediately and fire at 1600 RPM. When this is achieved locate the low fire adjustment screw as illustrated in Figure 30 and 31.

	Increase CO ₂	Decrease CO ₂
Low Fire Adjustment	↻ Clockwise	↺ Counter-Clock Wise

When the correct combustion values are achieved replace the screw cap back on to the gas valve.

- This boiler is designed for low fire soft start. At the start of trial for ignition the fan will decelerate to minimum fire and will light off at low fire before ramping up towards full input through the PWM signal from the controller.
- Shut power off to the heater and open the firing valve. Switch power back on and allow the burner to fire. Ignition should be smooth. Always make adjustments to meet the recommended CO₂ levels. Adjust low fire first followed by high fire adjustment.

To adjust the high-fire setting (DR 300 – 1800)

After the low fire settings are stable, ramp the boiler firing rate to 100% using the boiler control and bring the system temperatures up to 130F or to highest system design temperatures to minimize or eliminate condensate.

Use the Dynaforce® Control Panel:

- 1) Press **[DIAGNOSTICS]** button
- 2) Press **[Diagnostic Tests]** button
- 3) Move the firing rate slider to maximum RPM as indicated by the test sticker
- 4) Press **[Start Test]** to operate the boiler at max fire for 5 minutes.

Locate the input adjustment screw on the top side of the gas valve.

	Increase CO ₂	Decrease CO ₂
High Fire Adjustment	↺ Counter-Clock Wise	↻ Clockwise

After adjusting the screw wait a moment for the combustion levels to stabilize before attempting to make any further adjustments. Continue this procedure until combustion levels are satisfied.

To adjust the low-fire setting (DR 2000 – 5000)

Figure 34: SKP 55 Gas Valve

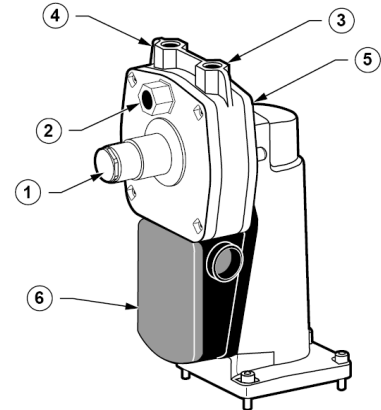

- 1 Adjustment of low fire bias
- 2 Connection for air pressure (+) sensing line
- 3 Connection for the air pressure (-) sensing line
- 4 Connection for the gas pressure (-) sensing line
- 5 Connection for the gas pressure (+) sensing line
- 6 Position indicator

Use the Dynaforce® Control Panel

- 1) Press **[DIAGNOSTICS]** button
- 2) Press **[Diagnostic Tests]** button
- 3) Move the firing rate slider to 20.0%
- 4) Press **[Start Test]** to operate the boiler at max fire for 5 minutes.

	Increase CO ₂	Decrease CO ₂
Low Fire Adjustment	↻ Clockwise	↺ Counter-Clock Wise

When the correct combustion values are achieved replace the screw cap back on to the gas valve.

To adjust the high-fire setting (DR 2000 – 5000)

One or more manometers should be connected to the Dynaforce® before proceeding to the next step to monitor the air and gas signal. Refer to Section 3.7 of this manual for details on connecting manometers.

After the low fire settings are stable, ramp the boiler firing rate to 100% using the boiler control and bring the system temperatures up to 130F or to highest system design temperatures to minimize or eliminate condensate.



Use the Dynaforce® Control Panel:

- 1) Press **[DIAGNOSTICS]** button
- 2) Press **[Diagnostic Tests]** button
- 3) Move the firing rate slider to 100.0%
- 4) Press **[Start Test]** to operate the boiler at max fire for 5 minutes.

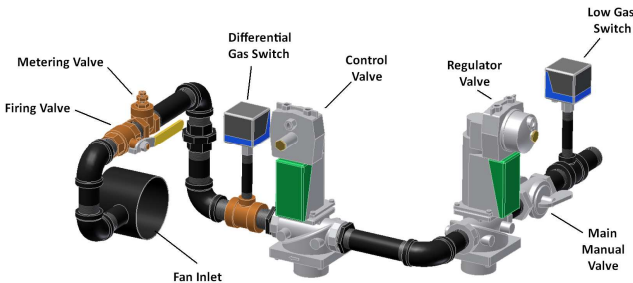
Figure 35: DR3500 – 5000 Gas Train Layout



Locate the metering valve on the gas train.

	Increase CO2	Decrease CO2
High Fire Adjustment	 Counter-Clock Wise	 Clockwise

Turn the screw 1/8 turn in either way for each adjustment to keep track of the adjustments. After adjusting the screw wait a moment for the combustion levels to stabilize before attempting to make any further adjustments. Continue this procedure until combustion levels are satisfied.

To reset the metering valve to factory settings refer to the chart below and the step-by-step instructions that follow.

Table 15: Inline metering valve setting

Model	LP Gas (Propane)	Natural Gas
	# of Turns Clockwise	# of Turns Clockwise
DR 2000	3 3/4	2 1/2
DR 2500	3 5/8	2 7/8
DR 3000	4	3
DR 3500	5 3/4	4
DR 4000	5 7/8	5
DR 4500	7 3/4	5
DR 5000	7 3/4	5

Step 1: Fully open inline metering valve (counter-clockwise)

Step 2: Close inline metering valve to preset level

Step 3: Above table shows initial settings only, fine-tuning will be required with the use of an analyzer.

- This boiler is designed for low fire soft start. At the start of trial for ignition the fan will decelerate to minimum fire and will light off at low fire before ramping up towards full input through the 4-20mA from the controller.
- Shut power off to the heater and open the firing valve. Switch power back on and allow the burner to fire. Ignition should be smooth. Normally the differential gas pressure will be identical to the differential air pressure. Actual differential pressure may vary from the numbers on the test label due to the field conditions and sample variations. Always make adjustments to meet the recommended CO₂ levels. Adjust high fire first followed by low fire adjustment.
- Allow the water temperature to rise so that the heater cycles on the operator.
- Check the temperature rise across the heat exchanger. This will be indicated by taking a difference between the inlet and outlet temperatures on the Dynaforce® control. For hydronic applications and for domestic hot water, a rise exceeding 30°F is not normally recommended.

• Allow the unit to cycle on the limit. This can be done by gradually restricting outlet water flow. The auto reset limits are set at 200°F for domestic hot water and hydronic heating. The manual reset limits are set to 210°F.

- Remove fan inlet filter. At full input, block 50% of the fan inlet opening. The display should show 'LCI not closed'. If it does not, slowly turn the adjustment on the normally closed blocked flue switch clockwise until the blocked flue switch indicator de-energizes.
- Check the air proving switch. Remove the restriction from the fan inlet and reset the power on the control panel. A properly set air switch will cause the interrupted air switch indicator to turn green at a fan speed between 15Hz and 20Hz on the VFD.
- Check the ignition retries circuit.
- Shut the main gas off to the unit and allow it to try for ignition. Trial for ignition should commence within 30 seconds.

8.4 COMMISSIONING APPLIANCE

- Remove manometers and replace inlet gas pressure test plug.
- Fill out start up report for each heater. Be sure to record all settings and readings. Retain a copy of report for future reference.
- Start up is now complete and heater may be placed into service.

PART 9 TROUBLESHOOTING

COMPONENT	FAILURE MODE	ANALYSIS
Incoming Power	<ul style="list-style-type: none"> • Two wires interchanged 	<ul style="list-style-type: none"> • No effect on safety • Live and Neutral wires are interchanged.
Transformer Tripped	<ul style="list-style-type: none"> • The 24Volts and 120 Volts wired are interchanged • Alert: 49 • Lockout: 53 	<ul style="list-style-type: none"> • Breaker on transformer trips
Relief Valve	<ul style="list-style-type: none"> • System pressure exceeds relief valve setting 	<ul style="list-style-type: none"> • Replace the standard relief valve with a higher rated valve up to the maximum pressure of the heat exchanger. • Improperly sized expansion tank.
Flow Switch	<ul style="list-style-type: none"> • Flow Switch contacts are open • Alert: 63, 275-281, 460 • LCI OFF 	<ul style="list-style-type: none"> • Verify that pump is operating • Verify for closed valves or obstructions in boiler piping • Verify that all air has been purged from the system • Verify that wiring is correct
Water Pressure Switch	<ul style="list-style-type: none"> • Pressure Switch contacts are open • Alert: 63, 275-281, 460 • LCI OFF 	<ul style="list-style-type: none"> • Verify that minimum water pressure exceeds 30 PSI • Verify that pump is operating • Verify for closed valves or obstructions in boiler piping • Verify that all air has been purged from the system • Verify that wiring is correct
Flame Failure	<ul style="list-style-type: none"> • The boiler has failed to ignite the burner • Alert: 110, 291-294 	<ul style="list-style-type: none"> • To reset the module refer to section 5.8.2 • Verify that all air has been purged from gas line • Inspect hot surface igniter and related wiring for damage and connection errors • DR 300 – 2500: Verify igniter is glowing • DR 3000 – 5000: Verify pilot is lit • Inspect flame sensor and associated wiring. Replace if necessary • Verify that boiler is properly grounded • Verify incoming gas supply pressure and that it coincides with Table 7. • Verify that the vent/ air inlet piping (if equipped) are correctly installed and obstructions are not present. • Verify 24 VAC (DR 300 – 1200) and 115VAC (DR 1400 – 5000) is being supplied to the gas valve relay from the Dynaforce® Controller during ignition. Check wiring from Dynaforce® Controller and Gas Valve Relay. If a signal cannot be detected, the Dynaforce® Controller needs to be replaced • If 24 VAC is present, check the outlet of the valve to ensure that gas is flowing. When the valve is energized a change in pressure should occur, if no change is detected the gas valve has failed to open or it is passing insufficient amount of gas. If this is an initial startup increase the low fire gas setting by ¼ turn clockwise. • Inspect the burner. Refer to Burner Maintenance in section 10.5 • Replace the Dynaforce® Controller, if necessary

COMPONENT	FAILURE MODE	ANALYSIS
<p>Flame Disappears During a Run Cycle</p>	<ul style="list-style-type: none"> The Dynaforce® boiler was running and flame signal suddenly disappeared. Lockout: 106, 107, 108, 109 	<ul style="list-style-type: none"> Verify that all air has been purged from gas line Verify that boiler is properly grounded Inspect flame sensor and associated wiring. Replace if necessary Check for flame sensor cracks in the insulator or continuity to ground Adjust the air proving switch. Turn counter-clockwise to reduce sensitivity Adjust the blocked flue switch. Turn clockwise to reduce sensitivity Verify incoming gas supply pressure and that it coincides with Table 7. Verify that the gas line connections to the boiler are adequate. Refer to Table 6. Verify that the vent/ air inlet piping (if equipped) are correctly installed and obstructions are not present Verify that 24 VAC is being supplied to the gas valve during operation. If a signal cannot be detected, the transformer needs to be replaced Inspect the burner. Refer to Burner Maintenance in section 10.5 Replace the Dynaforce® Controller if necessary
<p>Noisy Operation</p>	<ul style="list-style-type: none"> Supply Gas Issue Air/Gas Mixture Issue Air Inlet and/or Vent configuration Dirty/ Damaged Burner Fan is vibrating Air in the piping system 	<ul style="list-style-type: none"> Refer to Part 3 Gas Connection in this manual. Natural Gas Pressure reads between 3" w.c. and 14" w.c. L.P. Gas Pressure should be at 11" w.c. Refer to Section 8.3 Gas Valve Adjustment Procedure for proper combustion setting. Refer to Part 2 Air Inlet and Venting Refer to Burner Maintenance in section 10.5 of this manual for the burner removal and inspection procedure. Clean or replace the burner, if required. Check that all fan bolts are torqued to 20 lb-ft (DR300 – 1000), 25 lb-ft (DR1200 – 5000) Purge all air from the piping system
<p>Auto Reset High Limit Trips</p>	<ul style="list-style-type: none"> The outlet temperature has exceeded the set point temperature specified. Alert: 67, 79, 137, 303-310 ILK OFF 	<ul style="list-style-type: none"> Verify that the system is full of water and that all air has been properly purged from the system. Verify that ΔT does not exceed 30°F across the heat exchanger Verify that the boiler is piped properly. Verify that 120VAC is being supplied to the boiler pump on a call for heat. If voltage cannot be detected check wiring. Verify that the pump is circulating when 120VAC is detected. If not, pump impeller may be stuck. Use a flat head screwdriver on face of pump to turn impeller manually If 120VAC is present during a call for heat, but the pump still does not circulate, replace the pump. Replace the main Dynaforce® Controller if necessary

SYMPTOM	FAILURE MODE	ANALYSIS
Manual Reset High Limit Trips (if equipped)	<ul style="list-style-type: none"> Manual Reset Safety High Limit tripped, outlet temperature in excess of 210°F Alert: 63, 67, 79, 137, 276-281, 303-309 ILK OFF 	<ul style="list-style-type: none"> Verify that the capillary tube is broken. If this is the case, replace Manual Reset High Limit Verify that the system is full of water and that all air has been properly purged from the system. Verify that the boiler is piped properly. Verify that 120 VAC is being supplied to the boiler pump on a call for heat. If voltage cannot be detected check wiring. Verify that the pump is circulating when 120 VAC is supplied. If so, pump impeller may be stuck. Use a flat head screwdriver on face of pump to turn impeller manually. If 120 VAC is present during a call for heat, but the pump still does not circulate, replace pump.
Delta-T Limit Tripped	<ul style="list-style-type: none"> Outlet temperature has exceeded 40°F over inlet temperature Alert: 124 	<ul style="list-style-type: none"> Verify that the system is full of water and that all air has been properly purged from the system. Verify that the boiler is piped properly. Verify that 120VAC is being supplied to the boiler pump on a call for heat. If voltage cannot be detected check wiring. Verify that the pump is circulating when 120VAC is detected. If not, pump impeller may be stuck. Use a flat head screwdriver on face of pump to turn impeller manually If 120VAC is present during a call for heat, but the pump still does not circulate, replace the pump. Purge all air from the piping Verify boiler water pressure exceeds 30 PSI
Temperature Overshoot	<ul style="list-style-type: none"> Stack temperature has exceeded the limit temperature. Alert: 125 	<ul style="list-style-type: none"> The stack temperature has exceeded the maximum temperature allowed. PVC: 149°F CPVC: 194°F AL29-4C, Stainless Steel: 250°F Measure the resistance of the flue sensor at room temperature, it should be approximately 10kΩ.
	<ul style="list-style-type: none"> Outlet temperature has exceeded limit temperature. Alert: 63, 67, 79, 137, 276-281, 303-309 LCI OFF 	<ul style="list-style-type: none"> Verify that the system is full of water and that all air has been properly purged from the system Verify that the boiler is piped properly. Verify that adequate power is supplied to pump on a call for heat. If voltage cannot be detected check wiring Verify pump is circulating when power is supplied. If so, pump impeller may be stuck. If power is present during a call for heat, but the pump still does not circulate, replace the pump. Replace the Dynaforce® Controller, if necessary.
Sensor Not Connected	<ul style="list-style-type: none"> Inlet sensor, Alert: 91 Outlet sensor, Alert: 92 DHW sensor, Alert: 93 Stack sensor, Alert: 95 Outdoor sensor, Alert: 96 	<ul style="list-style-type: none"> Verify sensors are connected Verify wiring. Measure resistance of sensors, 10kΩ sensors. Replace sensor if necessary
Fan Not Turning	<ul style="list-style-type: none"> Fan refuses to rotate Alert 122, 123, 128, 129, 130, 131, 132 	<ul style="list-style-type: none"> Check fan power wires Fan signal wires are interchanged Minimum fan speed must be greater than 1600 RPM
Air Proving Switch	<ul style="list-style-type: none"> Interrupted Air Switch error Alert: 67, 137, 303-310 ILK OFF IAS OFF 	<ul style="list-style-type: none"> Air Switch wire(s) is/are loose Air Switch is set too tight, reduce sensitivity by turning screw ¼ turn counter-clockwise.
Blocked Flue Switch	<ul style="list-style-type: none"> LCI error Alert: 63, 137, 276-281 LCI OFF 	<ul style="list-style-type: none"> Blocked Flue Switch wire(s) is/are loose Blocked Flue Switch is set too tight, reduce sensitivity by turning screw ¼ turn clockwise.

SYMPTOM	FAILURE MODE	ANALYSIS
Flame Detection is out of Sync	<ul style="list-style-type: none"> Flame detection is present when no visible signs of a flame exist Lockout: 105, 158 	<ul style="list-style-type: none"> Verify supply voltage for proper polarity. Check external wiring for voltage feedback Check internal wiring for proper connections Check the flame sensor and verify that it is clean Replace Dynaforce® Controller, if necessary
Blank Display Screen	<ul style="list-style-type: none"> Blank display screen 	<ul style="list-style-type: none"> Check wire connections from Dynaforce® Controller to touchscreen display
Internal Fault	<ul style="list-style-type: none"> Lockout: 3-46, 58-60, 97-99, 143-148 	<ul style="list-style-type: none"> Reset SOLA, If fault persists, replace SOLA

Table 16: Lockout Codes

#	Description
1	Unconfigured safety data
2	Waiting for safety data verification
3-46	Internal Fault. Replace SOLA Controller
47	Flame rod to ground leakage
48	Static Flame
49	24VAC low/high
50	Modulation Fault
64	Fan speed not proved, ignition failure
67	Interlock Off, safety circuit is open
79	Heater Outlet high limit tripped
81	Delta T Limit
82	Stack limit tripped (PVC: 149°F, CPVC: 194°F, 250°F)
91	Inlet sensor fault
92	Outlet sensor fault
93	DHW sensor fault
94	Header sensor fault
95	Stack sensor fault
96	Outdoor sensor fault
105	Flame detected out of sequence
106	Flame lost if Main Flame Establishing Period (MFEP)
107	Flame lost early in run
108	Flame lost in run
109, 110	Ignition failed
112	Pilot test flame timeout
113	Flame circuit timeout
149	Flame detected

* If an internal hardware error is detected contact Camus® technical support for troubleshooting procedure.

Table 17: Alert/Hold Codes

#	Description
29	Burner switch turned OFF
30	Burner switch turned ON
47	Invalid subsystem request occurred
50	Modulation Fault (DR300 – 1000 ONLY)
54-56	Processor brown-out.
61	Anti-short Cycle
62	Fan speed not proved
63	LCI off, safety circuit is open
68	Setpoint was overridden due to sensor fault
69	Modulation was overridden due to sensor fault
123	Modulation rate was limited due to outlet limit
124	Modulation rate was limited due to Delta-T limit
215	No Lead Lag slaves available to service demand
219	Using backup Lead Lag header sensor due to sensor failure
229	Lead lag slave communication timeout.
275-281	LCI off, safety circuit is open
283	Demand off during measured purge time
291	Abnormal Recycle: Flame was not on at end of Ignition period
292	Abnormal Recycle: Flame was lost during Main Flame Establishing Period
293	Abnormal Recycle: Flame was lost early in Run
294	Abnormal Recycle: Flame was lost during Run
303-310*	Interlock Off, safety circuit is open
324, 374-379	Hardware flame bias. Flame sensor wire needs to be re-routed.
352*	Stack sensor fault
355*	Outlet sensor fault
357*	DHW sensor fault
359*	Inlet sensor fault
460	LCI lost in run
550	Delta T inlet/outlet limit was exceeded

* The alarm LED and alarm contacts are closed and will remain closed until the 'RESET' button is pressed.

- Alert 291: Abnormal Recycle: Flame was not on at end of ignition**
- Alert 292: Abnormal Recycle: Flame was lost during Main Flame Establishing Period**
- Alert 293: Abnormal Recycle: Flame was lost early in Run**
- Alert 294: Abnormal Recycle: Flame was lost during Run**
- Alert 324, 374-379: Abnormal Recycle: Hardware flame bias**

This error occurs when a flame signal is not detected by the flame sensor. A minimum signal of 0.8Vdc must be detected by the flame sensor to prove the flame.

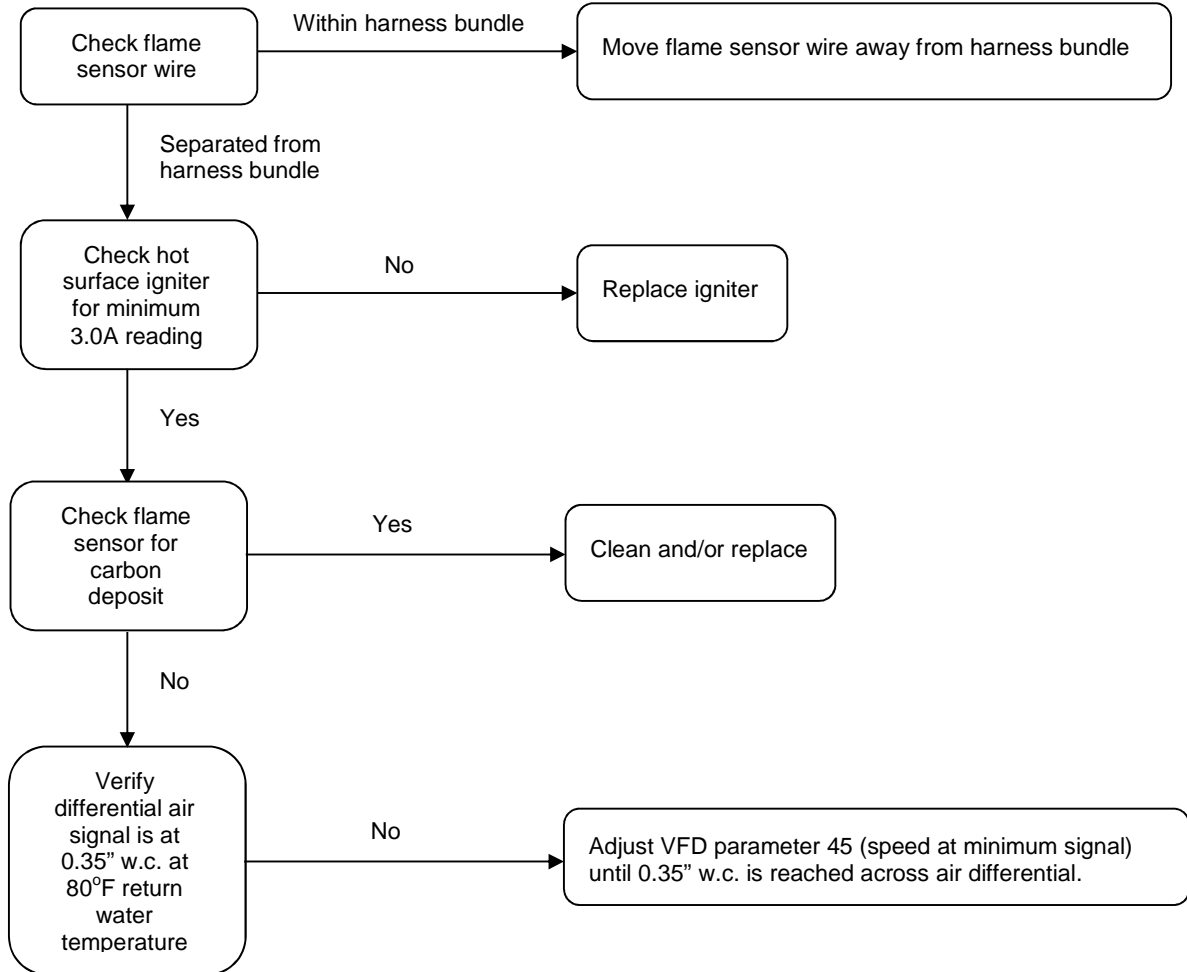

- Hold 63: LCI OFF (Load Control Input)
- Hold 67: ILK OFF (High Limit, Gas Pressure Switch, Air Switch)
- Alert 303: Abnormal Recycle: ILK off during drive to Purge
- Alert 304: Abnormal Recycle: ILK off during Measured purge time
- Alert 305: Abnormal Recycle: ILK off during Drive to Pre-ignition
- Alert 306, 307: Abnormal Recycle: ILK off during Pre-ignition
- Alert 308: Abnormal Recycle: ILK off during Main Flame
- Alert 309: Abnormal Recycle: ILK off during Ignition Period
- Alert 310: Run was terminated due to ILK was off
- Alert 460: LCI lost in run

This error occurs when one of more of the boiler safety switches are in an open condition when it is to be in a closed condition before the ignition sequence is allowed to proceed.

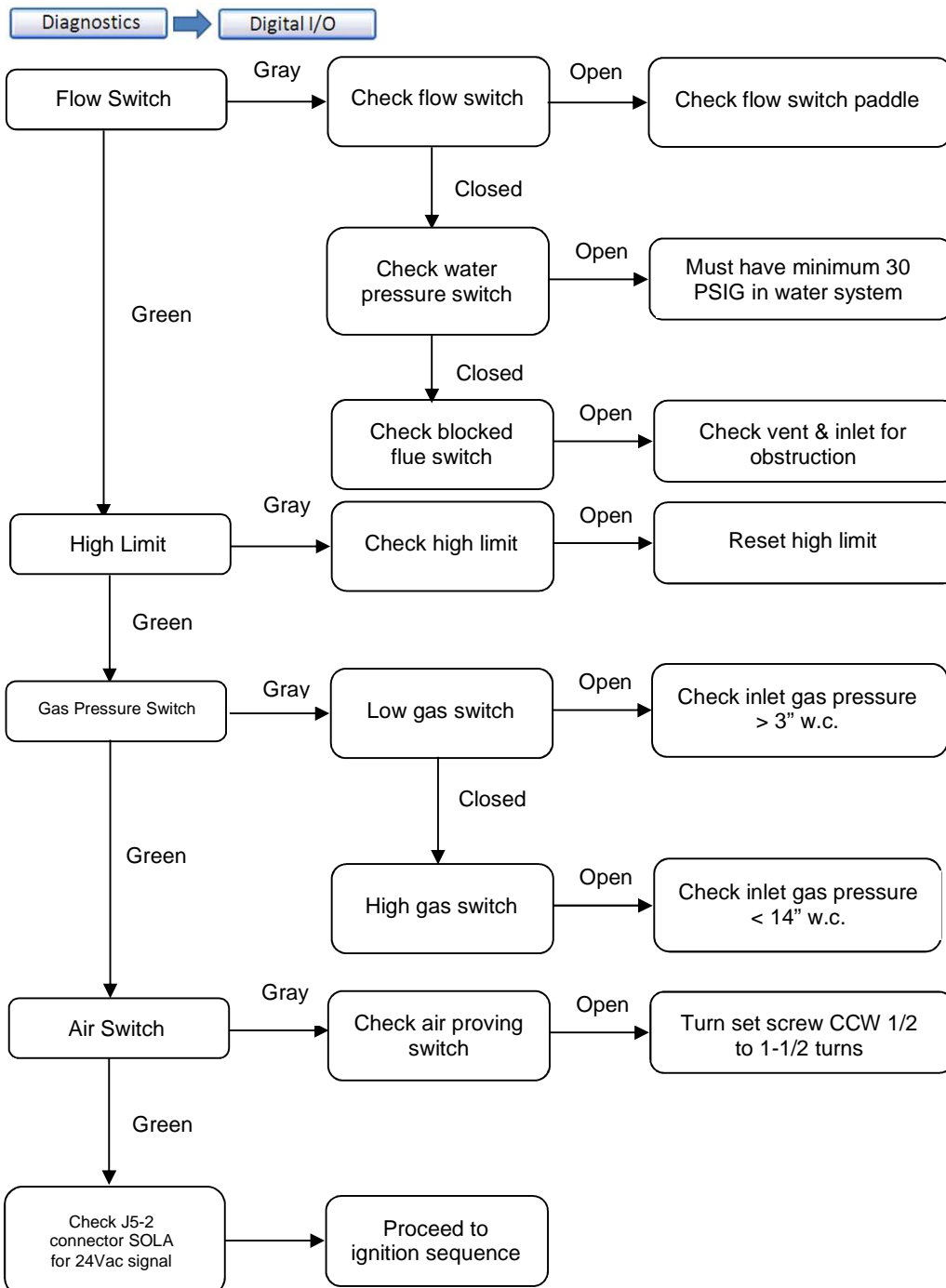

Alert 354: Abnormal Recycle Delta-T limit

This safety was breached as the inlet and outlet temperature difference exceeded 40°F. This is done to prevent damage to the heat exchanger. Before this error appears, the combustion air blower will slow down in an effort to prevent such an error from occurring.

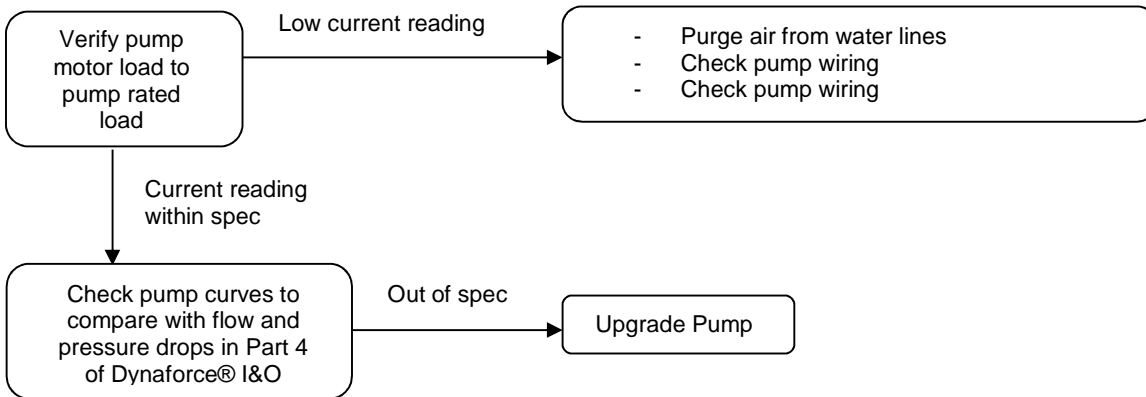

PART 10 MAINTANANCE

CAUTION

It is important that all gas appliances to be serviced by a Camus® trained service technician. It is in your own interest and that of safety to ensure that all local codes, and all the "NOTES" and "WARNINGS" in this manual are complied with. To service or adjust this appliance, it is imperative that the Camus® trained service technician utilize a combustion analyzer to read CO₂, CO and flue pressure according to Camus® Hydronics recommendation

CAUTION

Label all wires prior to disconnection when servicing controls. Wiring errors can cause improper and dangerous operation, verify proper operation after servicing.

Listed below are items that must be checked to ensure safe reliable operations. Verify proper operation after servicing.

10.1 EXAMINE THE VENTING SYSTEM

Examine the venting system at least once a year. Check more often in the first year to determine inspection interval. Check all joints and pipe connections for tightness, corrosion or deterioration. Flush the condensate drain hose with water to clean. Clean screens in the venting air intake system as required. Have the entire system, including the venting system, periodically inspected by a qualified service agency.

10.2 VISUALLY CHECK MAIN BURNER FLAMES

At each start up after long shutdown periods or at least every six months. A burner view port is located on the burner mounting flange.

CAUTION

The area around the burner view port is hot and direct contact could result in burns.

NOTE

Check torque on fan mounting nuts using a torque wrench.
DR300 – 1000: 20 lb-ft
DR1200 – 5000: 25 lb-ft

Figure 36: Normal Burner Flame Profile (short dense and blue)

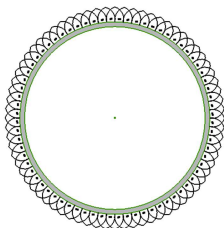

- Normal Flame: A normal flame at 100% of burner input is blue, with slight yellow tips a well defined flame and no flame lifting.
- Yellow Tip: Yellow tipping can be caused by blockage or partial obstruction of air flow to the burner.
- Yellow Flames: Yellow flames can be caused by blockage of primary air flow to the burner or excessive gas input. This condition **MUST** be corrected immediately.

- Lifting Flames: Lifting flames can be caused by over firing the burner, excessive primary air or high draft in excess of negative 0.15" W.C.

If improper flame is observed, examine the venting system; ensure proper gas supply and adequate supply of combustion and ventilation air.

10.3 FLUE GAS PASSAGEWAYS CLEANING PROCEDURES

Any sign of soot around the jacket, flue pipe connections, burner or in the areas between the fins on the stainless steel heat exchanger indicates a need for cleaning. The following cleaning procedure must only be performed by a Camus® trained service technician. Proper service is required to maintain safe operation. Properly installed and adjusted units seldom need flue cleaning.

NOTE:

All gaskets/sealant on disassembled components or jacket panels must be replaced with new gaskets/sealant on re-assembly. Gasket and sealant kits are available from the factory

CAUTION

When the vent system is disconnected for any reason it must be reassembled and resealed according to vent manufacturer's instruction

10.4 CONDENSATION TREATMENT

This high efficiency appliance may operate as a condensing appliance for extended periods of time based on return water temperatures. Condensate occurs when the products of combustion are cooled below their dew point in the heat transfer process. The liquid condensate formed from this high efficiency heat transfer process is mildly acidic. The condensate will typically have a pH ranging from 4.0 to 5.0 as it is discharged from the condensate drain at the rear of the appliance. The condensate trap where condensate is collected is constructed from a corrosion resistant stainless steel. All materials external to the appliance in contact with the condensate must be corrosion resistant. This is typically accomplished by using PVC or CPVC plastic pipe and synthetic tubing. Condensate must be able to flow freely from the appliance. All condensate flow is accomplished by gravity requiring a minimum downward slope of 1/4" per foot (21mm/m) to ensure proper flow to the condensate management system and/or a suitable drain. The neutralizer **MUST** always be mounted on the same level or lower than the bottom of the appliance cabinet and downstream of the condensate trap. The condensate trap is located external of the boiler and is to be secured to the floor or boiler pad to prevent spillage of condensate water. All condensate piping and connections must be easily accessible for routine maintenance and inspection.

10.4.1 CONDENSATE VOLUME

There are several factors affecting the amount of condensation created by the appliance however for rough approximation use.

Condensation Volume, US Gallon/Hr = Input, MBH/1000 x 5.0

Many codes will require the acidic condensate to be neutralized before it can be placed in a drain system. A neutralizer to control the pH of the liquid discharged to a drain system is recommended with every appliance. The neutralizer consists of an industrial grade, non-corrosive reservoir for collection of the condensate. As the reservoir fills, it provides an extended residency time to neutralize the condensate. The neutralized condensate exits from the reservoir outlet. A 'P' trap is installed upstream of neutralizer at the heat exchanger. Prime the installed assembly with water to prevent flue gas spillage from the drain. Use standard ½" vinyl, PVC, CPVC or suitable hose to run to floor drain.

When the condensate level in the reservoir rises to the drain, it spills out into the condensate bin and from there exits to the external neutralizer. As the pH number increases in numerical value, the relative acidity of the discharge decreases. The neutralized condensate may then be discharged into a suitable drain system without fear of damage to the drain system. Always check with local codes for specific pH requirements. Neutralizers may be used in series to raise pH.

The condensate collection box supplied with the Dynaforce® is supplied with an initial charge of neutralizer medium. This neutralizer medium is expected to last approximately 3 to 6 months depending on the amount of condensate produced. Neutralizer refills are available from Camus®.

10.5 BURNER MAINTENANCE

The burner should be removed for inspection and cleaning on an annual basis. An appliance installed in a dust or dirt contaminated environment will require inspection and cleaning on a more frequent schedule. The fan assisted combustion process may force airborne dust and dirt contaminants, contained in the combustion air, into the burner. With sustained operation, non-combustible contaminants may reduce burner port area, reduce burner inlet or cause non-warrantable damage to the burner.

Airborne contaminants such as dust, dirt, concrete dust or dry wall dust can be drawn into the burner with the combustion air and block the burner port area. An external combustion air filter is provided with the appliance. An additional filter is located at the fan inlet (DR1200 – 5000) and like the external filter may be washed in the sink under the tap. This internal filter should be checked and cleaned at the time of appliance commissioning and on a six month interval or more often in a contaminated environment.

10.5.1 BURNER REMOVAL

Access to the burner will require the following steps:

- Turn off main electrical power to the appliance.
- Turn off main manual gas shutoff to the appliance
- Remove the top cover.
- Disconnect the gas supply connection to the fan inlet.
- Disconnect the fan motor power wires at the harness.
- Remove the hot surface igniter and the flame sensor.
- Remove the sensing tubes from the air ratio gas valve to the combustion air fan.
- Remove the 4 nuts holding the fan assembly to the heat exchanger and remove the fan assembly. On occasion the red silicone gasket may adhere to the underside of the fan's flange. Carefully pry the flange away from the gasket prior to removing the fan assembly.
- The burner can now be lifted vertically out of the heat exchanger cavity. A graphite-backed ceramic paper gasket is located directly under the burner flange. This gasket must be replaced if it is damaged.
- Use care to prevent damage to the knitted metal fiber of the burner surface.
- Check all gaskets and replace as necessary. Gaskets affected by heat will not reseal properly and must be replaced.
- Replace the burner in the reverse order that it was removed. Insert the igniter and sensor before doing the final tightening on the fan mounting nuts. Evenly tighten the nuts to 20 ft-lbs (models 300 – 1000) and 25 ft-lbs (models 1200 – 5000)

NOTE:

When the combustion air fan is removed for any reason, the inlet to the burner must be covered to prevent further foreign objects from falling into the burner. Always look inside the burner to check for dents. Do not place a burner back into operation if the inner distribution screen has been dented during the service operation, call the factory for recommendations. Use care when removing and handling the burner, Sharp objects or impact may damage or tear the metal fiber surface rendering the burner unfit for service.

10.5.2 BURNER CLEANING PROCEDURE

Remove any visible dust or dirt blockage from the surface of the burner using water from a garden house. Wash the burner with low pressure water. Never wipe or brush the surface of the burner nor use high pressure water or air. The burner may best be cleaned by immersing the burner port area in a solution of dishwashing detergent and hot water. Allow the burner to remain in the solution for a short period of time to remove dust, dirt and oil or grease laden contaminants. Rinse the burner thoroughly with clean water to remove any residue from the detergent cleaner. The burner should be air dried after removal from the cleaning solution and rinsing. **DO NOT** use chlorine based solvents or cleaning agents on the burner.

10.6 CHANGING THE HOT SURFACE IGNITER

- The hot surface igniter is to be checked at least after every 4000 hours of operation and more frequently under high cycling conditions. This will maintain peak ignition efficiency.
- Turn off main electrical power to the appliance.
- Turn off main manual gas shutoff to the appliance.
- Locate the hot surface igniter.
- Disconnect the two power leads to the hot surface igniter.
- Loosen and remove the two screws that hold the igniter.
- Lift the igniter vertically out of the burner mounting flange. Use care, do not hit or break the silicon carbide igniter. **DO NOT** pull out by leads.
- Ensure that the ceramic paper gaskets used to seal the base and top of the igniter are reinstalled on the new igniter.

10.6.1 RE-INSTALLING THE IGNITER

- Confirm that the end of the replacement igniter has a bead of silicone sealing the gap between the metal mounting flange and the ceramic shaft of the igniter.
- Carefully insert the igniter into the mounting point on the burner flange and push into position on top of the fan's flange.
- Reinstall the two mounting head screws and tighten by hand only.
- Ensure that the igniter ceramic paper gaskets are properly installed and seal the point of contact between the igniter and fan mounting flange.
- Reconnect the power leads to the igniter.
- Turn on main gas supply.
- Turn on main power.
- Test fire the appliance to ensure proper operation.
- The igniter must generate a minimum of 3A to reliably light the main burner (models 300-2500) and pilot (models 3000 – 5000).

10.7 HEAT EXCHANGER INSPECTION

- The heat exchanger should be inspected at the time of burner maintenance.
- Turn off all power to the appliance.
- Turn off main gas to the appliance.
- Remove top cover.
- Remove fan assembly and burner as detailed in the Burner and Cleaning section.
- Check the heat exchanger surface for soot. If soot is present, heat exchanger must be cleaned
- Remove the front outer jacket door.
- Remove the top wrap to expose the baffles.
- Remove baffles from the exchanger.
- Use detergent water pressure wash to remove soot from heat exchanger and surfaces of the inner wrap.
- When necessary, the heat exchanger can be removed by disconnecting all water piping and removing the six flange mounting bolts at the rear of the appliance. The heat exchanger can now be removed from the front of the appliance.
- Reinstall baffles, stainless steel bands and stainless steel wrap. Replace any damaged gaskets to ensure a proper air seal. Replace any ceramic facing tape damaged on the baffles.

- Reinstall the burner and fan assembly.
- Reassemble all gas and water piping. Test for gas leaks.
- Reassemble outer jacket panels. Keep top cover off.
- Cycle unit and check for proper operation.
- Once proper operation is confirmed replace the top cover.

10.8 RE-INSTALL HEAT EXCHANGER

- Carefully reinstall the heat exchanger if removed from the appliance
- Check all silicon and viton gaskets and replace if damaged
- Reassemble inner wrap
- Cycle unit and check for proper operation
- Replace the top cover

10.9 COMBUSTION AIR FAN

Combustion air fan should be checked every 6 months. Clean the internal filter as required when installed in a dust or dirt contaminated location. The motor and bearings on the combustion air fan are sealed and permanently lubricated requiring no addition of oil or lubricants.

10.10 COMBUSTION AND VENTILATION AIR

Check frequently to be sure that the flow of combustion and ventilation air to the appliance is not obstructed. Combustion and ventilation air must be provided to the mechanical room with openings sized per the requirements of the B149 or National Fuel Gas Code. The optional outdoor air kit brings combustion air from the outdoors directly to the appliance.

10.11 CONTROL CIRCUIT VOLTAGE

This appliance uses a transformer to supply a low voltage control circuit. The voltage on the secondary side should be 24 to 28VAC when measured with a voltmeter. A secondary voltage of 21VAC or less supplied to 24VAC components may cause operational problems. A 4A circuit breaker is provided on the secondary side of the transformer. A tripped circuit breaker indicates a short in the 24VAC controls and must be corrected.

10.12 COMBUSTIBLE MATERIALS

CAUTION

Keep appliance clear from combustible materials; do not store **GASOLINE** and other flammable vapors and liquids in the proximity of the appliance.

10.13 FREEZE PROTECTION

Installations are not recommended in areas where the danger of freezing exists. Proper freeze protection must be provided for appliances installed outdoors, in unheated mechanical rooms or where temperatures may drop to the freezing point or lower. If freeze protection is not provided for the system, a low ambient temperature alarm is recommended for the mechanical room. Damage to the appliance by freezing is non-warrantable.

- **Location** - Heating boilers, hot water supply boilers or water heaters must be located in a room having a temperature of at least 50°F (10°C)

- **Caution** - A mechanical room operating under a negative pressure may experience a downdraft in the flue of an appliance that is not firing. The cold outside air may be pulled down the flue and freeze a heat exchanger. This condition must be corrected to provide adequate freeze protection.
- Freeze protection for the appliance using an indirect coil can be provided by using hydronic system antifreeze. Follow the manufacturer's instructions. **DO NOT** use undiluted or automotive type antifreeze.
- **Shut-down and draining** - If for any reason, the unit is to be shut off where danger of freezing exists, the following precautionary measures must be taken:
 - Shut off gas supply
 - Shut off water supply
 - Shut off electrical supply
 - Drain the heat exchanger completely
 - Ensure the pump and connecting piping are fully drained

10.14 FREEZE PROTECTION FOR A HEATING BOILER SYSTEM (Optional)

- Use only properly diluted inhibited glycol antifreeze designed for hydronic systems.
- Follow the instructions from the antifreeze manufacturer. Quantity of antifreeze required is based on total system volume including expansion tank volume.
- Antifreeze is denser than water and changes the viscosity of the system. The addition of antifreeze will decrease heat transfer and increase frictional loss in the boiler and related piping. Where antifreeze has been used, to maintain the temperature rise across the appliance confirm that the recommended GPM for pure water has been increased by 15% and the head loss by 20%.
- Local codes may require a back flow preventer or actual disconnect from city water supply when antifreeze is added to the system.
- When filling or topping-up the system with water mixed with the antifreeze always use distilled or RO (reverse osmosis) water. This will prevent the reaction of the water with antifreeze which can create sludge.

PART 11 INSTALLATIONS

WARNING

Before starting the boiler, smell near the floor and around the boiler for any gas odours or any unusual odour. Remove the stainless steel jacket and smell the interior of the boiler. If there is any sign of a gas leak, do not proceed with startup. Repair all the leaks before attempting to start the boiler

WARNING

Propane boilers ONLY – Your local propane supplier adds an odorant to the propane gas to allow for propane gas leak detection. In some cases, the added odorant can fade and the gas may not give off any noticeable odour. Before startup have the local propane supplier check for the correct odorant level in the gas.

11.1 CHECKING THE INSTALLATION

- Inspect the connections for water, gas and electricity.
- Inlet gas pressure must be a minimum of 7" W.C. for natural gas and 11" W.C. for propane.
- With the boiler off, open the main gas supply valve and vent the trapped air from the piping leading to the boiler. Confirm that all gas connections to the heater are tight and that there are no missing test plugs.

Refer to Section 8.3 Gas Valve Adjustment Procedure of the manual for recommendations on setting combustion characteristics

11.2 CHECKING THE INSTALLTION

- Check the boiler wiring to see that it agrees with the wiring diagram supplied.
- Confirm that all terminal strips and field connections are identified.
- With the boiler running, check for flue gas leaks along the inner cabinet joints and around the flue outlet.
- Repair any leaks prior to proceeding to the next step.
- At the factory, adjustments were made to achieve proper input and acceptable burner performance at full input and at minimum input.

11.3 INSPECT & RECHARGE CONDENSATE COLLECTION & NEUTRALIZING RESERVOIR

- 1) Inspect the 'P' trap and condensate reservoir in the Dynaforce®, making sure the collection box is intact.
- 2) Remove screws holding lid on to condensate collection box. Remove lid from the condensate collection box.
- 3) Fill with fresh water until the water begins to flow out of drain.
- 4) Re-install the lid and hold-down screws on the condensate collection box.
- 5) Inspect the condensate neutralizer supplied on site and confirm that it contains sufficient calcium carbonate to operate effectively to neutralize condensate to required level.
- 6) Check pH level of condensate.

WARNING

The condensate collection box must be filled with water to prevent flue gas emissions from escaping during boiler operation.

11.4 HEATING BOILER INSTALLATIONS

The appliance **MUST** always be installed in a **primary/secondary reverse return piping system for proper operation**. Before beginning the installation, consult local codes for specific plumbing requirements. The installation should provide unions and valves at the inlet and outlet of the appliance so it can be isolated for service. An air separation device must be supplied in the installation piping to eliminate trapped air in the system. Locate a system air vent at the highest point in the system. The system must also have a properly sized expansion tank installed. Typically, an air charged diaphragm-type expansion tank is used. The expansion tank must be installed close to the boiler and on the suction side of the system pump (appliance Inlet) to ensure proper operation. Caution: This appliance should not be operated at less than 30 PSIG. Water piping must be supported by suitable hangers or floor stands, NOT by the appliance. Pipe systems will be subject to considerable expansion and contraction. Pipe supports could allow the pipe to slide resulting in noise transmitted into the system. Padding is recommended. The boiler pressure relief valve must be piped to a suitable floor drain. See Section 4.10.

CAUTION

- 1) A leak in a boiler "System" will cause the "System" to intake fresh water constantly, which may cause the tubes to accumulate a lime/scale build up. This will be a **NON-WARRANTABLE FAILURE**.
- 2) If boiler pumps are not operated when treated water is introduced, a corrosion cell may be created in the boilers leading to a failure which is not covered by warranty.
- 3) Target water quality of treated water to be stable and neutral with regards to corrosive/scaling properties. Damage to or failure of the heat exchanger as a result of scaling or corrosive water quality is not covered by warranty.

11.5 WATER CONNECTIONS

All models have groove locked inlet and outlet stainless steel connections. Pipe size must be in accordance with Table 3 and, between supply and return lines, must not exceed 80 feet of equivalent length. Any reduction in recommended pipe size may decrease flow resulting in high water temperatures, boiler noise, flashing to steam and non-warrantable heat exchanger damage.

11.6 PIPING LENGTHS

The appliance circulator provides the water flow from the primary boiler piping, through the boiler and back to the primary system. Pipe diameter and length are critical to ensure proper flow through the boiler.

The secondary loop piping to and from the appliance must have a fully ported ball valve installed in both the inlet and outlet side piping and will be used for isolation only. The ball valves must be the same diameter as the installed piping. If flow control is required, other means of flow control such as globe valve or flow setter should be used.

11.7 INTERMITTENT PUMP OPERATION

An intermittent pump operation signal is standard and can be used to operate a separate pump contactor. A 1/6 hp pump delay relay is standard, and a 1 hp pump delay relay is available. When utilizing this feature, the boiler's integral circulating pump will cycle on at each call for heat, before the burner fires. The pump will continue to operate while the burner is firing. The pump will run for a post-pump period after the temperature set point is satisfied. This will remove any residual heat from the combustion chamber before turning the pump off. See wiring diagram shipped with the unit.

11.8 SUMMARY**a) Typical Boiler Installations****General Plumbing Rules**

- 1 Check all local codes.
- 2 For serviceability of boiler, always install unions.
- 3 Always pipe pressure relief valve to an open drain.
- 4 Locate system air vents at highest point of system.
- 5 Expansion tank must be installed near the boiler and on the suction side of the system pump.
- 6 Support all water piping.

b) Placing the Boiler in Operation**Pre-Start Check List**

- 1 Review the location of the boiler, clearances from combustible surfaces and available service clearances.
- 2 Review Part 2 Venting. Ensure that all vent components are fabricated from the correct category of materials with adequate clearance from combustibles.
- 3 Ensure that the boiler condensate drain and all vent system condensate drains are properly routed to an acceptable floor drain or neutralization system.
- 4 Review the vent termination point for proper location and clearances.
- 5 Ensure that proper volumes of combustion and ventilation air are provided to the mechanical room. If a separate combustion air pipe is used, ensure that it is properly sized, sealed and terminated.
- 6 Review the water piping from the boiler to the system. The boiler must be installed in a primary/ secondary piping system. Review the diameter and equivalent length of the installed piping to and from the boiler for proper flow.
- 7 Ensure that a properly sized primary system pump is installed with an expansion tank.
- 8 Check system pressure. Ensure a minimum of 30 PSIG with the system hot and not more than 90% of the rated pressure of the relief valve.
- 9 Review the installed gas piping from the meter to the boiler. Ensure that the gas pipe, meter and any regulators are adequately sized.
- 10 Review the field wiring and electrical service for both the boiler controls and pump. Ensure that the electrical service(s) is adequately sized.

Boiler Set-Up

- 1 Ensure that the boiler and piping system are full of water. Bleed all air from the pump housing and secondary loop.
- 2 Check system for any water leaks.
- 3 Check system for installation of glycol or water treatment where required. Where glycol has been used to maintain the temperature rise across the appliance confirm that the recommended flow for pure water has been increased by 15% and the head loss by 20%.
- 4 Turn on power to the primary system pump and the appliance secondary pump and verify operation.

Boiler Operational Checks

- 1 Turn the boiler main power switch to the "ON" position.
- 2 Program the adjustable points.
- 3 Turn the switch to the "ON" position to start boiler operation.
- 4 Push the resets for low water level, high water temperature and alarm.
- 5 Install a manometer on the gas supply to the boiler and verify minimum gas supply pressure as the burner fires at 100% of rated input.
- 6 Verify operation of safeties as necessary (low water cut-off, high limit, gas pressure, etc.).
- 7 Once the boiler is running and the flame has stabilized, remove the flame sensor wire at the sensor. Main flame must extinguish within 4 sec. If flame does not extinguish replace the ignition control.

Boiler Operation

- 1 Appliance should begin the start-up process for the sequence of operation.
- 2 The boiler will fire down to 20% on initial start-up and adjust input as required to meet system demand.
- 3 Based on system demand, the appliance will modulate accordingly.
- 4 As system demand is satisfied, the burner will cycle off and the combustion air fan will decelerate at a pre-programmed rate before the appliance shuts down.

DR 300 – DR 2500

FOR YOUR SAFETY READ BEFORE OPERATING

WARNING: If you do not follow these instructions exactly, a fire or explosion may result causing property damage, personal injury or loss of life.

A. This appliance does not have a pilot. It is equipped with an ignition device which automatically lights the burner. Do not try to light the burner by hand.

B. BEFORE OPERATING smell all around the appliance area for gas. Be sure to smell next to the floor because some gas is heavier than air and will settle on the floor.

WHAT TO DO IF YOU SMELL GAS

- DO NOT TRY TO LIGHT ANY APPLIANCE.
- DO NOT TOUCH ANY ELECTRIC SWITCH.
- DO NOT USE ANY PHONE IN YOUR BUILDING.
- IMMEDIATELY CALL YOUR GAS SUPPLIER FROM A NEIGHBOUR'S PHONE. FOLLOW THE GAS SUPPLIER'S INSTRUCTIONS.
- IF YOU CANNOT REACH YOUR GAS SUPPLIER, CALL THE FIRE DEPARTMENT.

C. Use only your hand to turn the Manual Gas Cock control handle. Never use tools. If the handle will not turn by hand, don't try to repair it, call a qualified service technician. Force or attempted repair may result in a fire or explosion.

D. Do not use this appliance if any part has been under water. Immediately call a qualified service technician to inspect the appliance and to replace any part of the control system and any gas control which has been under water.

E. Do not operate appliance unless unit is filled with water and inlet valves are fully open.

MANUAL GAS COCK

"OFF" POSITION



FIGURE "A"

"ON" POSITION



FIGURE "B"

OPERATING INSTRUCTIONS

1. STOP! Read the safety information above on this label.
2. Turn off all electric power to the appliance.
3. Set the thermostat to lowest setting.
4. This appliance is equipped with an ignition device which automatically lights the burner. Do not try to light the burner by hand.
5. Turn the Manual Gas Cock clockwise to "OFF" (Fig. "A")
6. Wait five (5) minutes to clear out any gas. Then smell for gas, including near the floor. If you smell gas, STOP! Follow "B" in the safety information above on this label. If you don't smell gas, go to the next step.
7. Turn Manual Gas Cock counterclockwise to "ON". (Fig. "B")
8. Set thermostat to desired setting.
9. Turn on all electric power to the appliance. The main burner will be light directly.
10. If the main burner fails to ignite, follow the instructions "To Turn Off Gas to Appliance" and call your service technician or gas supplier.

TO TURN OFF GAS TO APPLIANCE

1. STOP! READ THE SAFETY INFORMATION ABOVE ON THIS LABEL.
2. Turn off all electric power to the appliance if service is to be performed.
3. Set the thermostat to lowest setting.
4. Turn the Manual Gas Cock clockwise to "OFF" position. Do not force. See step 5 above and diagrams.

STKR-001-A

DR 3000 – DR 5000

FOR YOUR SAFETY READ BEFORE OPERATING

WARNING: If you do not follow these instructions exactly, a fire or explosion may result causing property damage, personal injury or loss of life.

A. This appliance is equipped with an ignition device which automatically lights the pilot. Do not try to light the pilot by hand.

B. BEFORE OPERATING smell all around the appliance area for gas. Be sure to smell next to the floor because some gas is heavier than air and will settle on the floor.

WHAT TO DO IF YOU SMELL GAS

- DO NOT TRY TO LIGHT ANY APPLIANCE.
- DO NOT TOUCH ANY ELECTRIC SWITCH.
- DO NOT USE ANY PHONE IN YOUR BUILDING.
- IMMEDIATELY CALL YOUR GAS SUPPLIER FROM A NEIGHBOUR'S PHONE. FOLLOW THE GAS SUPPLIER'S INSTRUCTIONS.
- IF YOU CANNOT REACH YOUR GAS SUPPLIER, CALL THE FIRE DEPARTMENT.

C. Use only your hand to turn the Manual Gas Cock control handle. Never use tools. If the handle will not turn by hand, don't try to repair it, call a qualified service technician. Force or attempted repair may result in a fire or explosion.

D. Do not use this appliance if any part has been under water. Immediately call a qualified service technician to inspect the appliance and to replace any part of the control system and any gas control which has been under water.

E. Do not operate appliance unless unit is filled with water and inlet valves are fully open.

MANUAL GAS COCK

"OFF" POSITION



FIGURE "A"

"ON" POSITION



FIGURE "B"

OPERATING INSTRUCTIONS

1. STOP! Read the safety information above on this label.
2. Turn off all electric power to the appliance.
3. Set the thermostat to lowest setting.
4. This appliance is equipped with an ignition device which automatically lights the pilot. Do not try to light the pilot by hand.
5. Turn the Manual Gas Cock clockwise to "OFF" (Fig. "A")
6. Wait five (5) minutes to clear out any gas. Then smell for gas, including near the floor. If you smell gas, STOP! Follow "B" in the safety information above on this label. If you don't smell gas, go to the next step.
7. Turn Manual Gas Cock counterclockwise to "ON". (Fig. "B")
8. Set thermostat to desired setting.
9. Turn on all electric power to the appliance. Pilot burner will be ignited by electronic spark. After pilot ignites, the main burner will ignite.
10. If pilot fails to ignite, observe pilot using inspection mirror and check for an ignition spark. If the appliance will not operate, follow the instructions "To Turn Off Gas to Appliance" and call your service technician or gas supplier.

TO TURN OFF GAS TO APPLIANCE

1. STOP! READ THE SAFETY INFORMATION ABOVE ON THIS LABEL.
2. Turn off all electric power to the appliance if service is to be performed.
3. Set the thermostat to lowest setting.
4. Turn the Manual Gas Cock clockwise to "OFF" position. Do not force. See step 5 above and diagrams.

STKR-001

11.9 DOMESTIC HOT WATER HEATER

Hot water heaters are designed for installation with a storage tank. The operation of the properly sized circulating pump, the piping between the tank and heater and the control of water velocity, as explained below, are important for correct operation of your hot water heater.

11.10 WATER VELOCITY CONTROL

To ensure proper velocity through the heat exchanger(s), it is necessary to select the proper pump. Temperature rise at full fire will be an indication of flow. This must be done on initial installation and periodically rechecked.

Excessive lime/scale build-up in the heat exchanger tubes is a result of restricted flow and too little velocity in the tubes. Care should be taken to maintain required water velocity based on water condition as follows:

11.11 TEMPERATURE RISE AT FULL FIRING RATE

- 1 The pump must run continuously when the burner is firing.
- 2 With the pump running and the burner in the appliance in the off cycle, the inlet temperature and outlet temperature readings on the display should read approximately the same temperatures.
- 3 Turn the hot water heater on and allow time for the temperature to stabilize. Check the temperature rise when the burner is firing at 100% of rated input.
- 4 Compare the temperature rise on the Dynaforce® display with the required temperature rise at the required flow rate based on water condition (Soft, Normal, and Hard). Should adjustment be needed, proceed as follows:

If the temperature rise is too high, the water velocity is too low. Adjust as follows:

- 1 Check for flow restrictions. Check for debris in strainers
- 2 Check diameter and equivalent length of the piping between the storage tank and hot water heater.
- 3 Be sure all valves are open between the hot water heater and the storage tank. Ensure that all ball valves are fully ported.
- 4 Check the pump to be sure it is running properly and that the pump motor is running in the proper direction.
- 5 Be sure the pipes between the hot water heater and storage tank are not more than a total of 80 equivalent feet between inlet and outlet lines. If maximum equivalent length for the specified pipe diameter is exceeded, larger diameter pipe may have to be installed to achieve correct flow and temperature rise.
- 6 Common manifold piping for multiple unit installations will require larger minimum pipe sizes and tank circulating tapping to ensure proper flow.

If the temperature rise is too low, the water velocity is too high. Adjust as follows:

- 1 Temperature rise can be increased by slowly closing the flow control valve (globe valve or flow setter) in the outlet piping from the hot water heater to the storage tank to achieve the proper temperature rise.
- 2 Sustained high water velocity and low temperature rise may result in pitting or erosion of the stainless steel tubes in the heat exchangers. This is a non-warrantable failure. Temperature rise must be properly adjusted to achieve the specified flow rate.

The required temperature rise and the recommended pump size are based on the heating of potable water with normal hardness. For DHW applications with other than normal hardness, choose a pump for the local water hardness conditions. Alternatively, soften the water to normal levels. Damage to the heat exchanger as a result of scaling or corrosive water conditions in non-warrantable.

CAUTION

Temperature rise cannot be adjusted when the burner is firing at less than 100% of input rate.

11.12 WATER HEATERS

The manufacturer recommends the use of a properly sized thermostatic mixing valve to supply domestic hot water at temperatures less than 140°F (60°C). Storing the water at a higher temperature and thermostatically mixing the water will decrease the size of the storage tank and increase the available quantity of mixed hot water.

- Piping components connected to the water heater for a space heating application shall be suitable for use with potable water.
- Toxic chemicals, used for boiler treatment, shall not be introduced into the potable water used for space heating
- A water heater which will be used to supply potable water shall not be connected to any heating system or component(s) previously used with a non-potable water heating appliance
- When a system requires water for space heating at temperatures higher than required for other uses, a means such as a mixing valve shall be installed to temper the water for those uses in order to reduce scald hazard potential.

CAUTION

Adequate care **MUST** be taken to prevent potential scald injury when storing water at 140°F (60°C) and hotter.

WARNING

Should overheating occur or the gas supply fail to shut off, do not turn off or disconnect the electrical supply to the pump, instead, shut off the gas supply at a location external to the appliance.

PART 12 EXPLODED VIEW

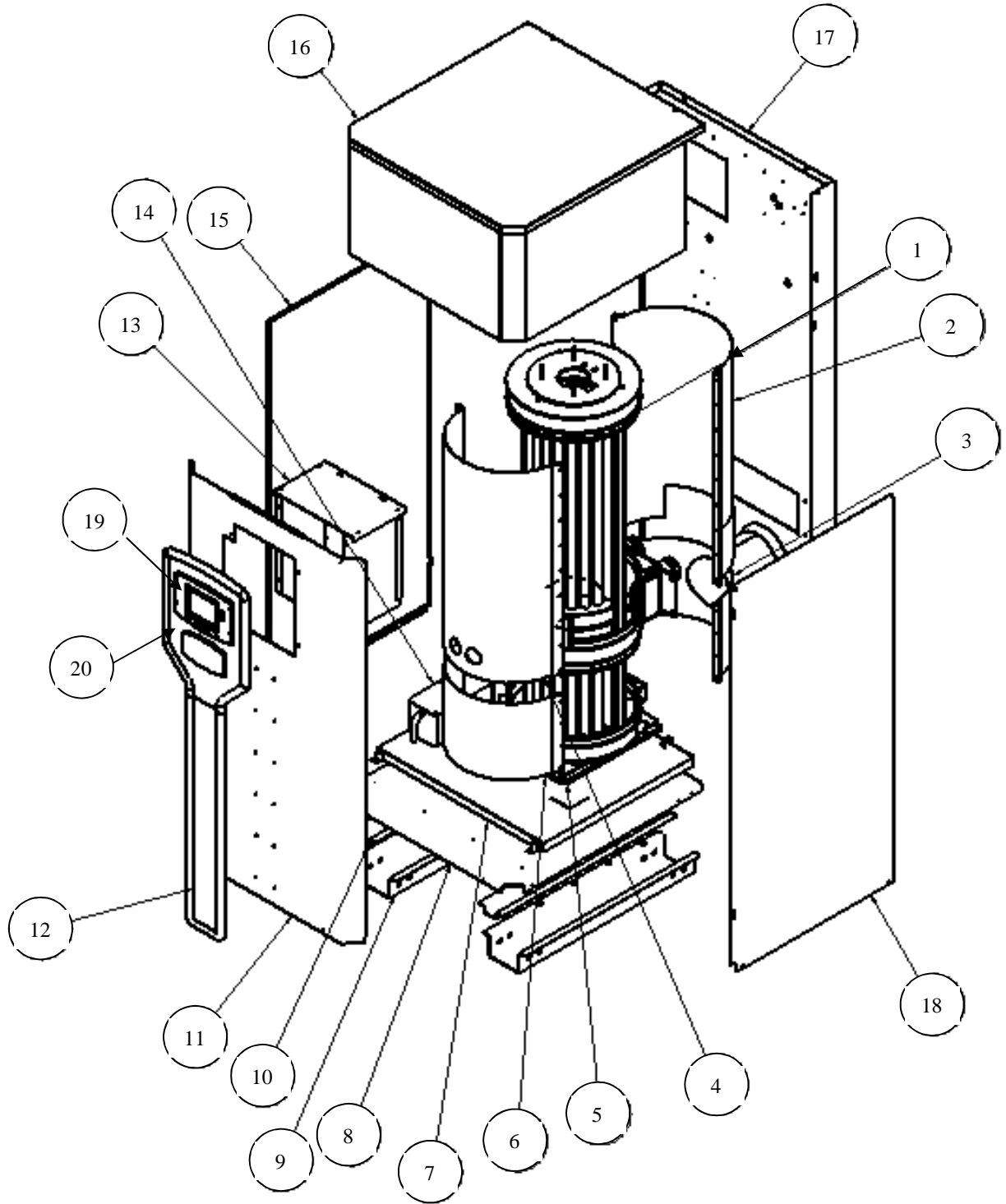

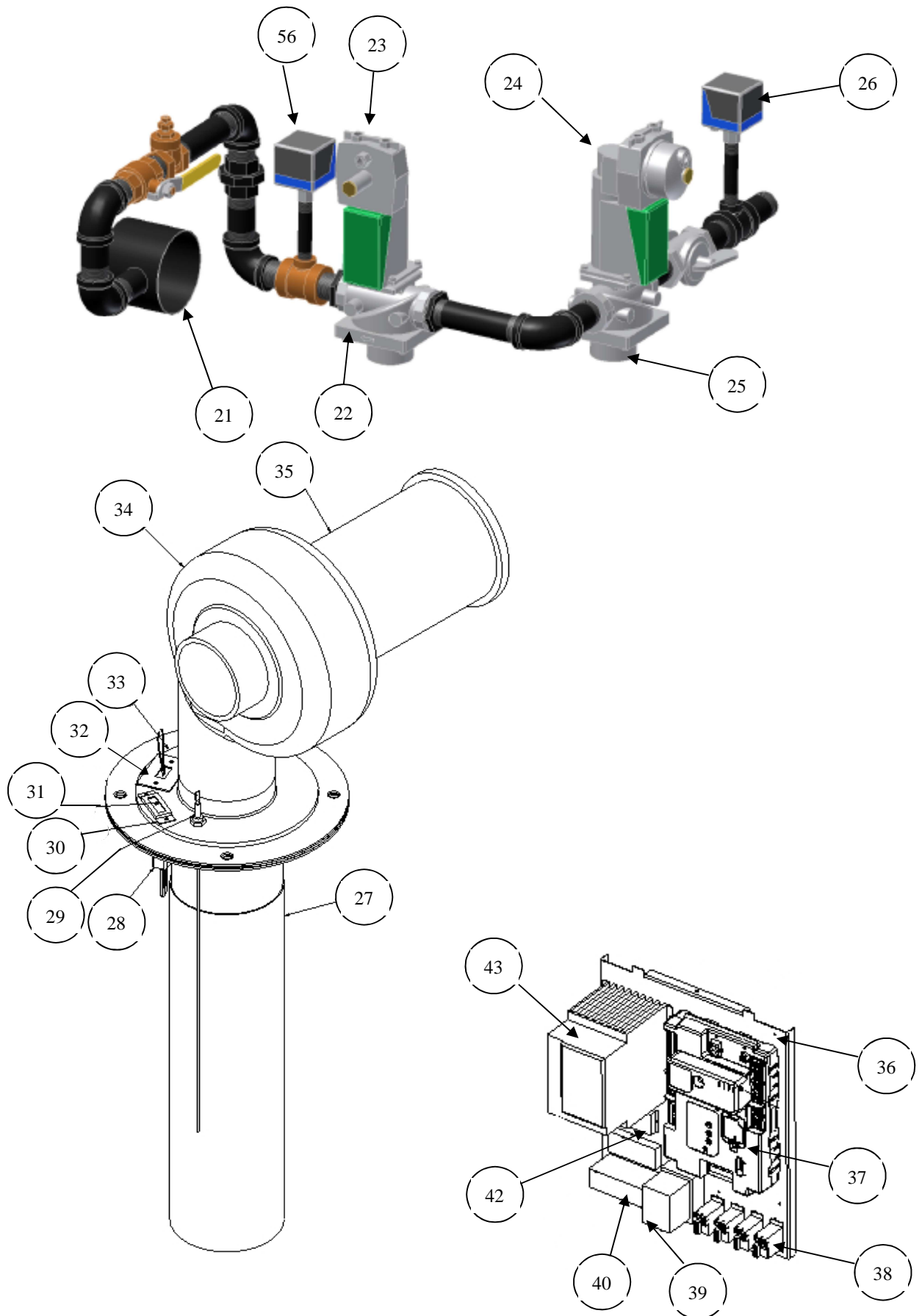

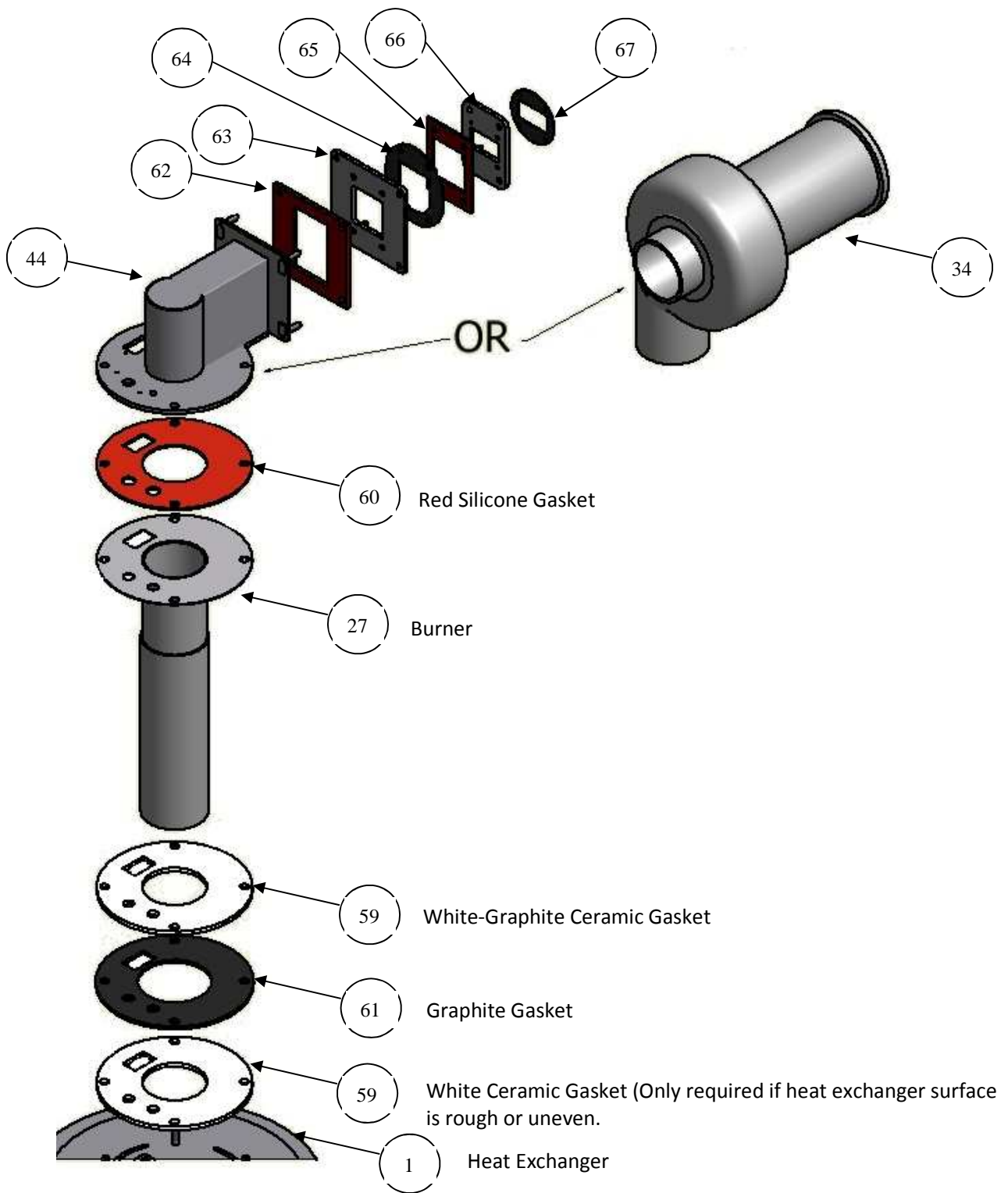

Ref #	Part Name	Part ID	Dynaforce® Models																			
			ALL	300	350	400	500	600	800	1000	1200	1400	1600	1800	2000	2500	3000	3500	4000	4500	5000	
1	Heat Exchanger (Incl. "V" Baffles)	15-2001		X	X																	
		15-2002				X	X															
		15-2003						X	X													
		15-2004									X	X										
		15-2005										X										
		15-2006											X	X								
		15-2007													X							
		15-2008														X						
		15-2009															X					
		15-2010																X	X			
		15-2011																			X	
		15-2012																				X
2	Wrap Assembly	90-14005		X	X																	
		90-9100-04				X	X															
		90-15209						X	X													
		90-14011								X	X											
		90-14013										X										
		90-15209											X	X								
		90-15210													X							
		90-14017														X						
		90-15099															X					
		90-2010																X	X			
		90-2011																		X		
		90-2012																				X
5	Base Support	14-1025		X	X	X	X	X	X	X	X	X										
		14-1073									X	X	X	X	X	X						
		14-1018															X	X				
		14-1071																	X	X	X	
7	Condensate Bin Assembly	14-1024		X	X	X	X	X	X	X												
		14-1010									X	X	X	X	X	X						
		14-1017															X	X	X	X	X	
8	Base Panel	14-5012A		X	X	X	X	X	X	X												
		14-5206A									X	X	X	X	X	X						
		14-5306															X	X	X	X	X	
9	Base Support Leg	14-6007A		X	X	X	X	X	X	X												
		14-5207A									X	X	X	X	X	X						
		14-5307															X	X	X	X	X	
10	Base Support Stiffener Under Leg	14-6010A		X	X	X	X	X	X	X												
		14-5212A									X	X	X	X	X	X						
		14-5312															X	X	X	X	X	

Ref #	Part Name	Part ID	Dynaforce® Models																			
			ALL	300	350	400	500	600	800	1000	1200	1400	1600	1800	2000	2500	3000	3500	4000	4500	5000	
11	Front Panel	14-1045		X	X																	
		14-1041				X	X															
		14-1055						X	X													
		14-1020								X												
		14-1059									X											
		14-1012										X	X	X								
		14-1004													X							
		14-1027														X						
		14-1006																X				
		14-1064																	X	X		
		14-1014																			X	
14-1068																					X	
12	Bezel	90-10015		X	X																	
		90-10011				X	X															
		90-10019						X	X													
		90-10009								X	X											
		90-10002										X	X	X								
		90-10001													X	X	X	X				
13	Control Box	14-1030		X	X	X	X	X	X	X									X	X	X	
		14-1005									X	X	X	X	X	X	X	X	X	X	X	
14	Condensate Neutralizer Box	90-10030	X																			
15	Side Panel Left	14-1047		X	X																	
		14-1043				X	X															
		14-1057						X	X													
		14-1022								X												
		14-1061									X											
		14-8085										X	X	X								
		14-1008													X							
		14-1028														X						
		14-1015															X					
		14-1065																X	X			
16	Top Cover	14-6030A		X	X	X	X	X	X	X												
		14-5228A									X	X	X	X	X	X						
		14-5329-45-50															X	X	X	X		
		14-5329-60																			X	
17	Back Panel	14-1046		X	X																	
		14-1042				X	X															
		14-1056						X	X													
		14-1021								X												
		14-1060									X											
		14-1011										X										
		14-1121											X	X								
		14-1000													X							
		14-1026														X						
		14-1002															X					
		14-8088																X	X			
		14-8089																		X		
		14-8090																			X	
18	Side Panel Right	14-1048		X	X																	
		14-1044				X	X															
		14-1058						X	X													
		14-1023								X												
		14-1062									X											
		14-8084										X	X	X								
		14-1007													X							
		14-1029														X						
		14-1016															X					
		14-1066																X	X			
14-1050																		X				
14-1070																				X		

Ref #	Part Name	Part ID	Dynaforce® Models																				
			ALL	300	350	400	500	600	800	1000	1200	1400	1600	1800	2000	2500	3000	3500	4000	4500	5000		
19	Dynaforce® Display	S7999D1006 (7" screen)	X																				
20	On/Off Switch	C6000ALBBXCHLI	X																				
21	Venturi/ Air Gas Inlet Adapter	45900450-010		X	X	X																	
		VMU300A1046					X	X	X	X													
		13-0026									X	X	X	X	X								
		66-5005														X							
		13-0027																X	X	X			
		66-5011																			X	X	
22	Gas Valve Body	VGG10.404U													X	X	X						
		VGG10.504U (Requires 2)																X	X				
		VGD40.065U																		X	X		
23	Gas Valve	VR8615B1044		X	X	X																	
		V8730C1015					X																
		V8730C1023						X	X	X													
		V8730C1031									X												
		V4734C1002										X	X	X									
		SKP55													X	X	X	X	X	X	X	X	
24	Gas Valve Solenoid	V4295A1049													X								
		V4295A1056														X	X						
	Gas Valve Regulator	SKP 25															X	X	X	X			
25	Gas Valve Regulator Body	VGG10.404U															X	X	X	X			
26	Low gas Switch	C6097A	X																				
27	Main Burner	DR-300-BRN		X	X																		
		DR-400-BRN				X	X																
		DF-500-BRN						X	X														
		DR-1000-BRN								X	X												
		DF-1200-BRN										X											
		DF-1500-BRN											X										
		DF-1750-BRN												X	X								
		DF-2000-BRN														X							
		DF-3000-BRN																X					
		DR-4000-BRN																	X	X	X	X	
28	Hot Surface Igniter	271RSHORT		X	X	X	X																
		271R						X	X	X	X	X	X	X	X	X	X	X	X	X	X		
29	Flame Rod	PSE-CH5	X																				
30	Sight Glass Holder	14-0049	X																				
31	View Port Glass	TG-94010-040	X																				
32	Igniter Mounting Flange	13-5335	X																				
33	Fan Flange	14-5560		X	X	X	X	X	X	X													
		13-5052									X												
		13-5330										X	X	X									
		13-5331													X	X							
		13-5332																X	X	X	X		

Ref #	Part Name	Part ID	Dynaforce® Models																			
			ALL	300	350	400	500	600	800	1000	1200	1400	1600	1800	2000	2500	3000	3500	4000	4500	5000	
34	Combustion Fan	150563-05		X	X	X																
		55667.14002					X															
		150232-07						X	X	X												
		AF9									X	X	X	X								
		AF10													X	X	X					
		AF12																X	X	X		
		AF15																				X
35	Electrical Motor	1 HP, D393									X	X	X	X								
		1 1/2 HP, D394													X	X						
		2 HP, D395															X					
		3 HP, D396																X				
		5 HP, C204B																	X	X	X	
36	Control Box Plate	14-1005-03	X																			
37	Honeywell SOLA	R7910A1001	X																			
38	Relay(s)	1649341-8	X																			
39	115/24Vac Transformer	HCT-01J2BB07	X																			
40	0-10Vdc Converter (if equipped)	ETISO-V	X																			
42	24V Contactor	T92P7A22-24															X	X	X	X	X	
43	Variable Frequency Drive	T204									X	X	X	X								
		T205												X	X							
		T217															X	X				
		T228																X	X	X		
	Variable Frequency Drive (460V/60/3)	T234									X	X	X	X								
		T235												X	X							
		T237														X	X	X				
	T238																	X	X			
44	Transition Arm	14-5560		X	X	X	X	X	X	X										X	X	
45	Pilot Tube	11-0015														X	X	X	X	X		
46	Blocked Flue Switch	SMD 8021205256	X																			
47	Air Proving Switch	NS2-1427-00	X																			
48	Intake Adapter	10", GZ-GFIF-2000-CH & GAA1A-1100-CH									X	X										
		10", GZ-GFIF-2000-CH & GAA1A-1500-CH											X	X	X							
		12", GFIF-3000-CH & GAA1A-3000-CH													X	X	X					
		14", GFIF-5000-CH & GAA1A-5000-CH																X	X	X		
49	Rear Fan Intake Filter	6", DM-14-0117		X	X	X	X															
		8", DM-14-0118						X	X	X	X	X										
		10", DF-14-0119											X	X	X							
		12", DF-14-0120													X	X	X	X				
		14", DF-14-0121																	X	X		
50	Fan Intake Filter	AF9									X	X	X	X								
		AF10													X	X	X					
		AF12																X	X	X		
		AF15																			X	

Ref #	Part Name	Part ID	Dynaforce® Models																			
			ALL	300	350	400	500	600	800	1000	1200	1400	1600	1800	2000	2500	3000	3500	4000	4500	5000	
51	Inlet Sensor	198799Z/U	X																			
52	Outlet Sensor	50001464-005/B	X																			
53	Outdoor Sensor	Tekmar 070/071	X																			
		NTC-Sensor-004	X																			
54	Flue Sensor	NTC-Sensor-003	X																			
55	Electrical Box	14-0263	X																			
56	Differential Gas Switch	C6097B	X																			
57	Water High Limit	L6008A1242 (Auto Reset)	X																			
		L4008E1313 (Manual Reset)	X																			
58	Water Pressure Switch	HB26A218L	X																			
59	Graphite-Backed White Ceramic Gasket(1)	33-5244		X	X	X	X	X	X	X	X	X										
		33-5241											X	X	X	X						
		33-5243																X				
		33-5245																	X	X	X	X
60	Red Silicone Gasket (1)	33-5221		X	X	X	X	X	X	X												
		33-5218									X	X										
		33-5224											X	X	X	X						
		33-5227																X				
		33-5230																	X	X	X	X
61	Graphite Gasket (1)	33-5239		X	X	X	X	X	X	X	X	X										
		33-5237											X	X	X	X						
		33-5238																X				
		33-5240																	X	X	X	X
62	DR600-800 1/8" Red Gasket for Mixing Chamber	33-0057		X	X	X	X	X	X	X												
63	Air Inlet to Fan Adapter	16-0016					X															
64	RG175 Fan Gasket	33-0038					X															
65	DR300-400 1/8" Red Gasket	33-0058		X	X	X																
66	Air Inlet to Fan Adapter	16-0015		X	X	X																
67	RG148 Fan Gasket	33-0037		X	X	X																
68	Stainless to Plastic Adapter	4" to 4", 300142		X	X	X																
		5" to 6", 300143					X	X														
		6" to 6", 300144							X	X	X											
		7" to 8", 300145										X	X									
		8" to 8", 300146												X	X							
69	Wire Harness	77-0038	X																			
70	1" White Ceramic Gasket (Baffles, primary wrap)		X																			
71	2" White Ceramic Gaske (Stiffener, primary ring)		X																			
72	Black Viton Solid Gasket (Secondary heat exchanger)		X																			
73	Black Viton Foam Gasket (Secondary wrap)		X																			
74	Snap Action Thermostat	EKA-114-58	X																			
75	Manual Shutoff Kit	50002653-001					X	X	X	X												
	Not shown in exploded view																					
Part	Recommended spare parts																					

PART 13 ELECTRICAL DIAGRAMS

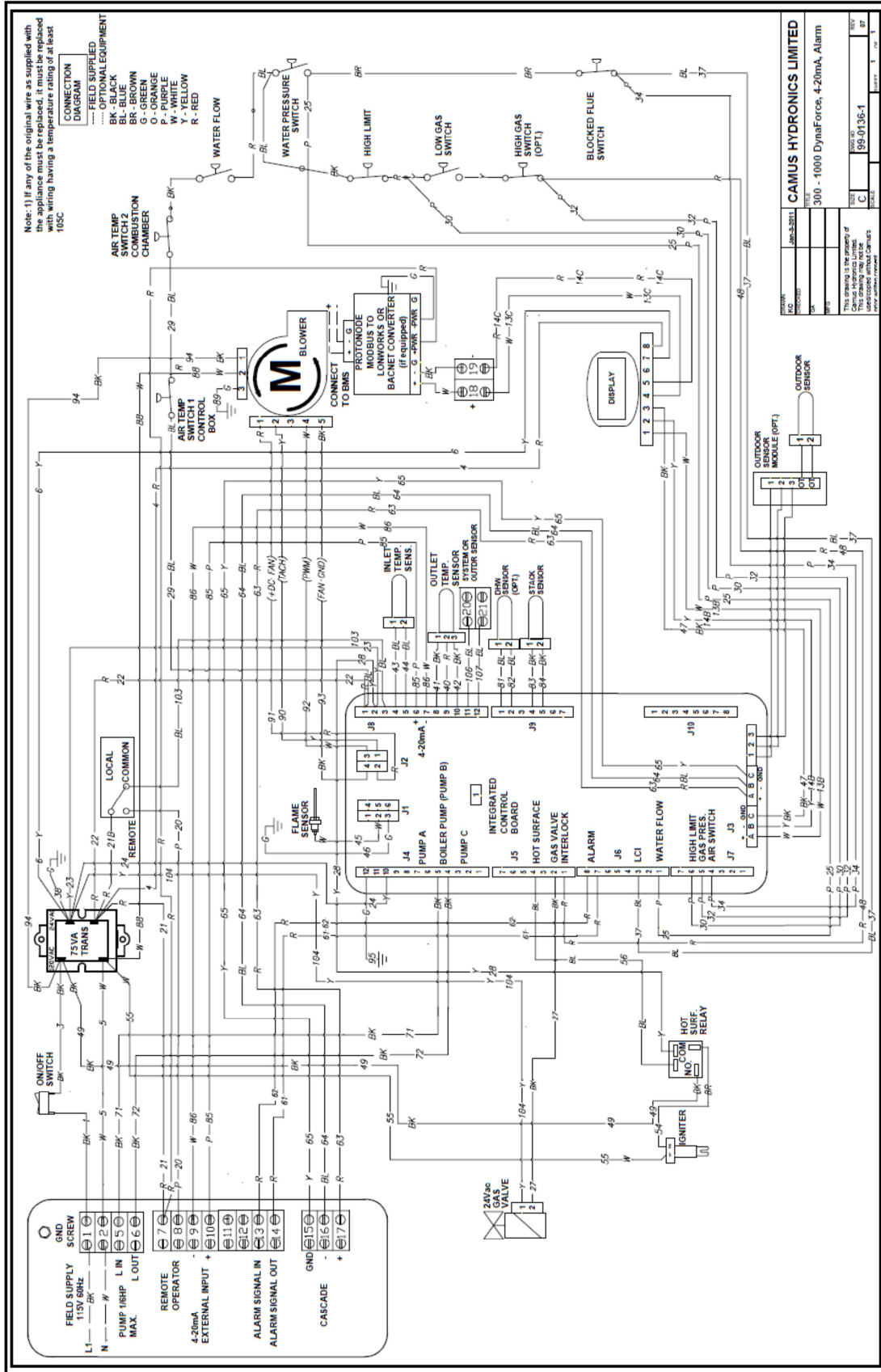

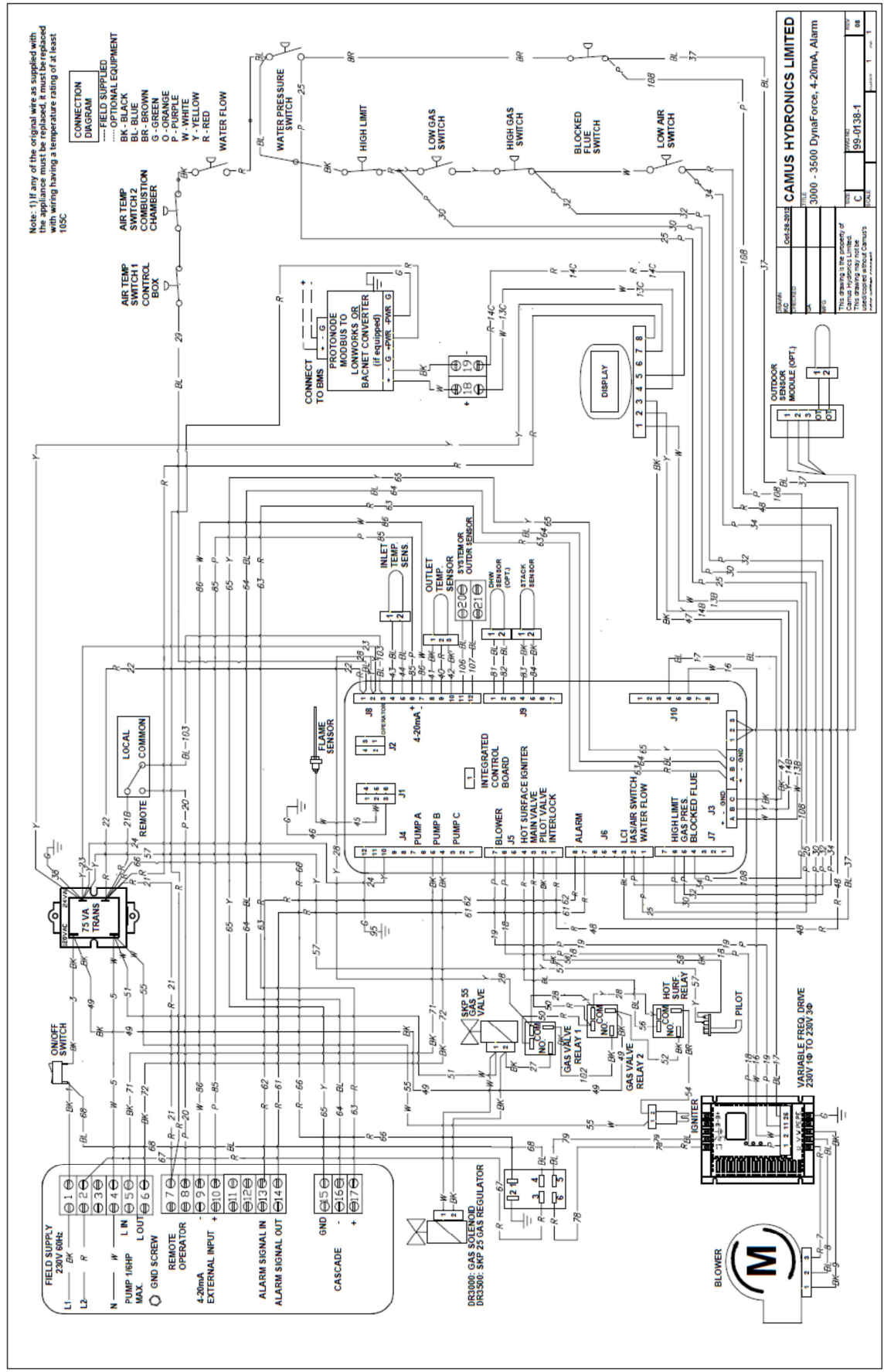

CAMUS HYDRONICS LIMITED

3000 - 3500 DynaForce, 4-20mA, Alarm

REV	DATE	DESCRIPTION
1	10/08	ISSUE
2	01/09	REVISED
3	01/09	REVISED
4	01/09	REVISED
5	01/09	REVISED
6	01/09	REVISED
7	01/09	REVISED
8	01/09	REVISED
9	01/09	REVISED
10	01/09	REVISED
11	01/09	REVISED
12	01/09	REVISED
13	01/09	REVISED
14	01/09	REVISED
15	01/09	REVISED
16	01/09	REVISED
17	01/09	REVISED
18	01/09	REVISED
19	01/09	REVISED
20	01/09	REVISED
21	01/09	REVISED
22	01/09	REVISED
23	01/09	REVISED
24	01/09	REVISED
25	01/09	REVISED
26	01/09	REVISED
27	01/09	REVISED
28	01/09	REVISED
29	01/09	REVISED
30	01/09	REVISED
31	01/09	REVISED
32	01/09	REVISED
33	01/09	REVISED
34	01/09	REVISED
35	01/09	REVISED
36	01/09	REVISED
37	01/09	REVISED
38	01/09	REVISED
39	01/09	REVISED
40	01/09	REVISED
41	01/09	REVISED
42	01/09	REVISED
43	01/09	REVISED
44	01/09	REVISED
45	01/09	REVISED
46	01/09	REVISED
47	01/09	REVISED
48	01/09	REVISED
49	01/09	REVISED
50	01/09	REVISED
51	01/09	REVISED
52	01/09	REVISED
53	01/09	REVISED
54	01/09	REVISED
55	01/09	REVISED
56	01/09	REVISED
57	01/09	REVISED
58	01/09	REVISED
59	01/09	REVISED
60	01/09	REVISED
61	01/09	REVISED
62	01/09	REVISED
63	01/09	REVISED
64	01/09	REVISED
65	01/09	REVISED
66	01/09	REVISED
67	01/09	REVISED
68	01/09	REVISED
69	01/09	REVISED
70	01/09	REVISED
71	01/09	REVISED
72	01/09	REVISED
73	01/09	REVISED
74	01/09	REVISED
75	01/09	REVISED
76	01/09	REVISED
77	01/09	REVISED
78	01/09	REVISED
79	01/09	REVISED
80	01/09	REVISED
81	01/09	REVISED
82	01/09	REVISED
83	01/09	REVISED
84	01/09	REVISED
85	01/09	REVISED
86	01/09	REVISED
87	01/09	REVISED
88	01/09	REVISED
89	01/09	REVISED
90	01/09	REVISED
91	01/09	REVISED
92	01/09	REVISED
93	01/09	REVISED
94	01/09	REVISED
95	01/09	REVISED
96	01/09	REVISED
97	01/09	REVISED
98	01/09	REVISED
99	01/09	REVISED
100	01/09	REVISED

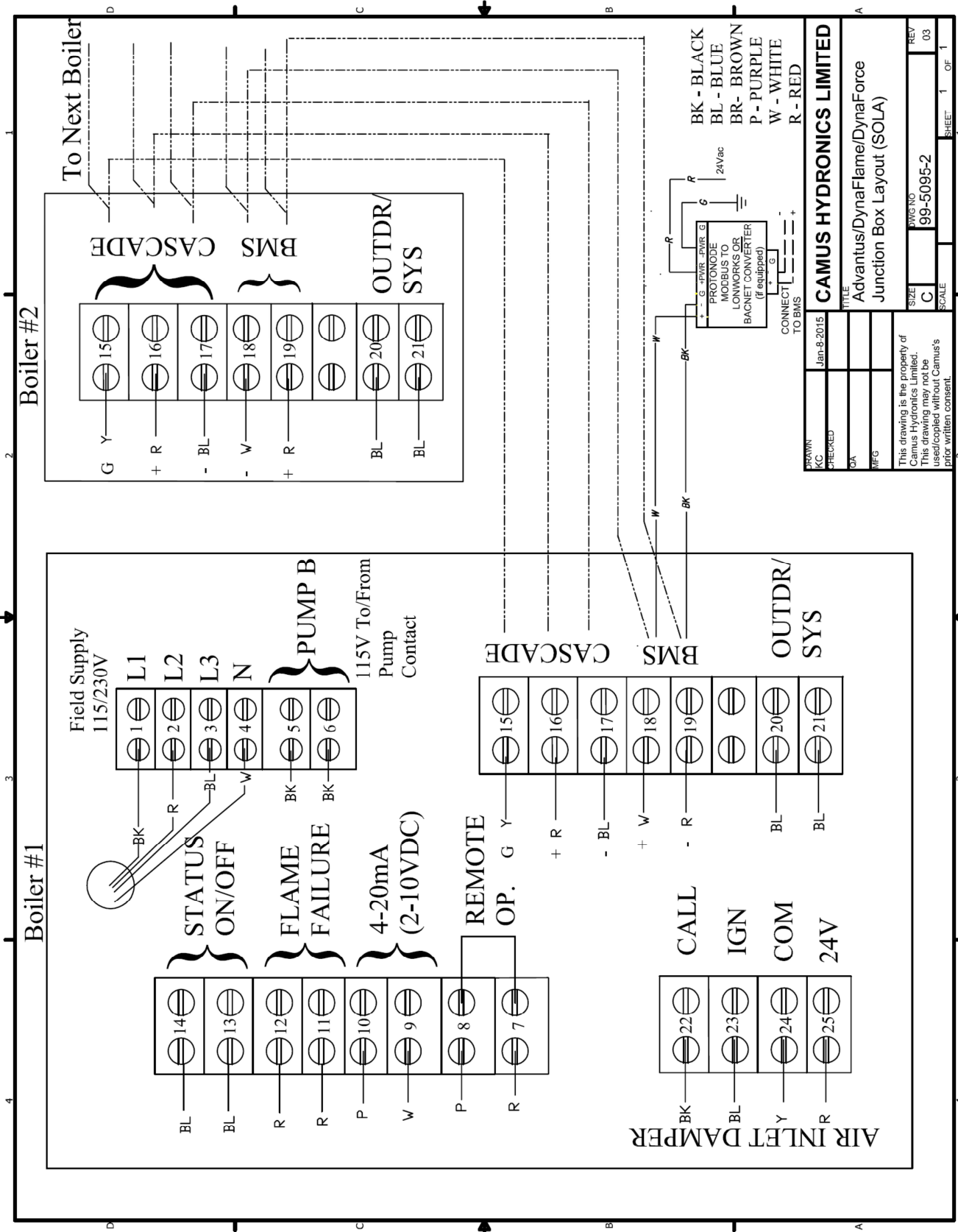

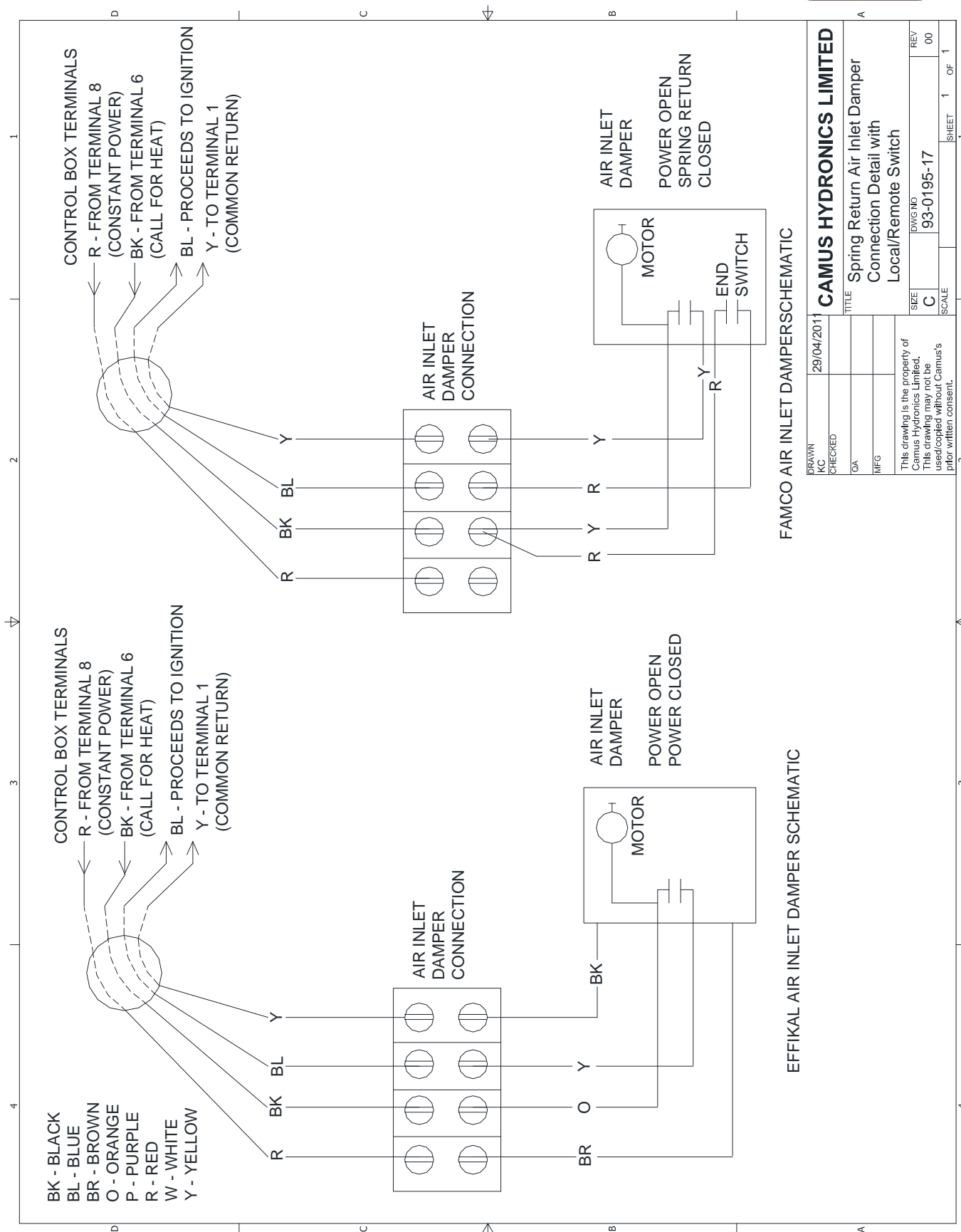

DRAWN KC	29/04/2011	CAMUS HYDRONICS LIMITED
CHECKED		TITLE
QA		Spring Return Air Inlet Damper
MFG		Connection Detail with
		Local/Remote Switch
<small>This drawing is the property of Camus Hydraulics Limited. This drawing may not be reproduced without Camus's prior written consent.</small>		SIZE C
	DWG NO 93-0195-17	REV 00
	SCALE	SHEET 1 OF 1

#8 BUILDING MANAGEMENT SYSTEM CONTROL - ONE TO EIGHT BOILERS

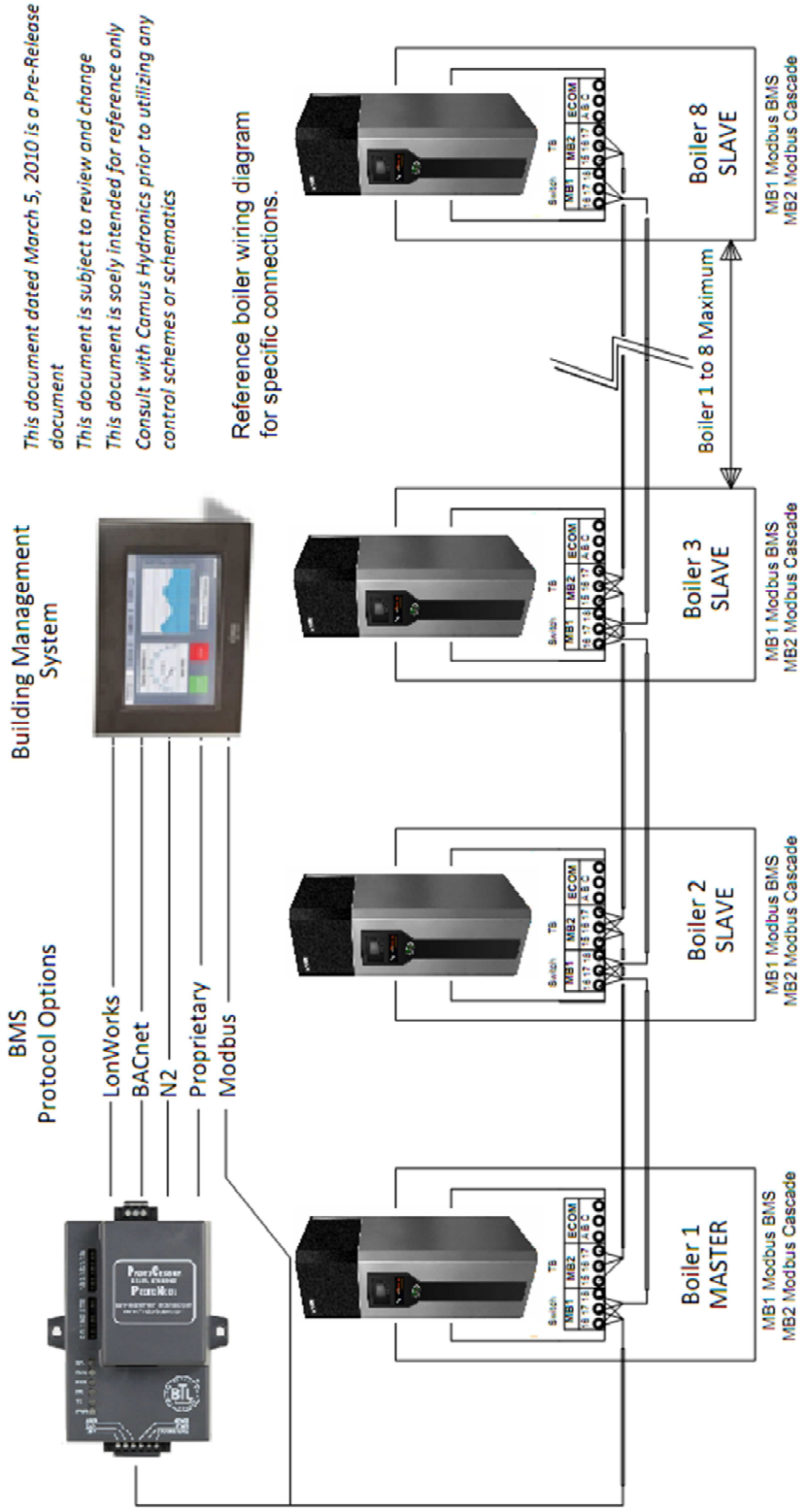

This document dated March 5, 2010 is a Pre-Release document
 This document is subject to review and change
 This document is solely intended for reference only
 Consult with Camus Hydraulics prior to utilizing any control schemes or schematics

Reference boiler wiring diagram for specific connections.

Operation:

- Control up to 8 boilers - Modbus protocol
- Multi-Signal conversion of Building Management System (BMS) protocol to Sola - Modbus by optional BMS Protocol Converter (attached)
- Access to all boiler configurations from multiple boiler protocol source interfaces
- Establish full Sola control interface configurations for parameter settings and control operation
- Limited parameter access per Camus factory SOLA programming
- Establish a back up boiler to boiler Modbus interface for Sola master / slave lead lag operation control
- Establish boiler base and modulation Control Algorithm operation
- Establish inlet or remote target temperature set point, remote tank, system, or outdoor reset control
- Optional Boiler Remote / Local Modbus interruption for emergency, service, or offline boiler operation

WARNING:
 This drawing shows suggested control and interface configuration.

DATE	REV	DESCRIPTION
Mar. 5 2010	1	CP
CAMUS HYDRONICS LIMITED		
DynaForce - Control Interface #8 BMS 8 Boilers Cascade Lead Lag Multiple Protocol		
SIZE	SCALE	REV
A	None	00
This drawing is the property of Camus Hydraulics Limited. This drawing may not be used/copied without Camus's prior written consent.		

HONEYWELL SOLA LEAD LAG OPERATION UP TO 9 BOILERS

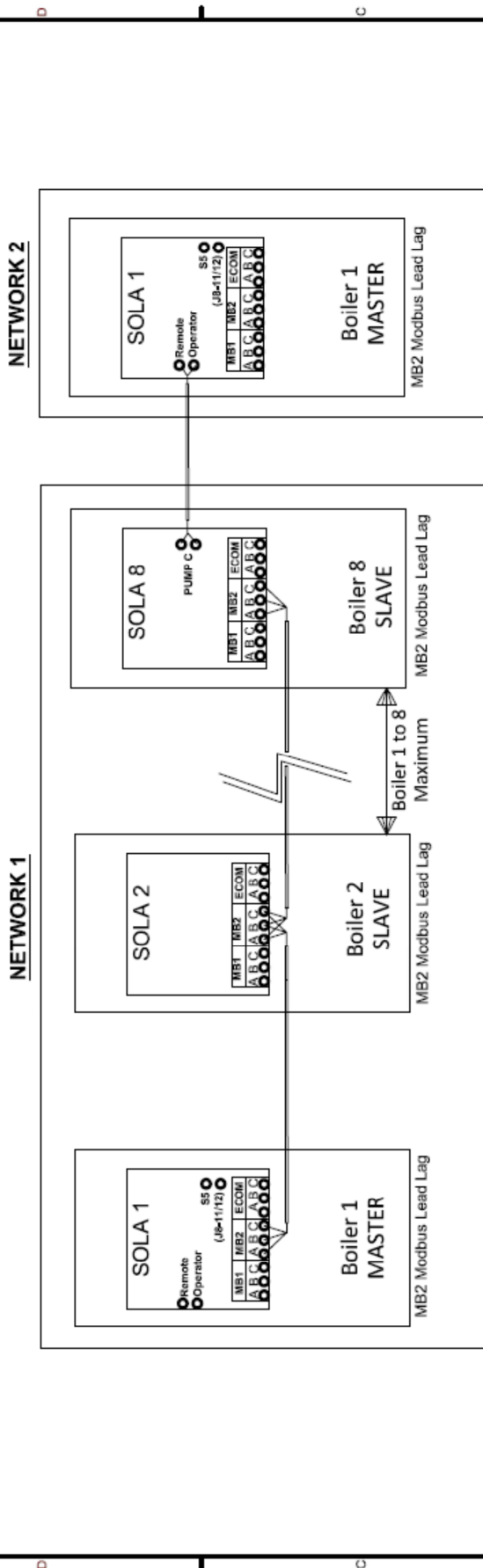

Sensor Wiring:

Each Network must have independent S5 (Lead Lag) sensors and they must be positioned closely together in building piping and wired to respective SOLA 1. Network 1 Outdoor sensor is to be wired to S5 (J8-11/12), if applicable. Network 2 Outdoor sensor is to be wired to ECOM using Outdoor Reset Module (W8735S1000), if applicable.

Operation:

Network 1 supports up to 8 boilers operating in lead lag with SOLA 1 acting as the master. Based on Lead Lag sensor this will govern if additional boilers in Network 1 is required. Refer to I&O Manual for additional details on lead lag operation within a single network. Network 2 supports up to a maximum of 4 boilers operating in lead lag. Network 1 SOLA 8 Pump C contacts are wired to Network 2 SOLA 1 Remote Operator Contacts. Network 1 SOLA 8 activates Network 2 SOLA 1 through the use of Pump C contact on R7910A1001. Pump C is activated on a time delay algorithm, where the timer is initiated when SOLA 8 begins ignition sequence. Pump C Time Delay (Register #293) = Interstage Delay (Default: 2 mins) x Number of Boilers. Network 2 operates independently of Network 1.

Note:

Due to rotation of leaders in Network 1; SOLA 8 may become lead boiler. Operation is not impacted regardless of lead boiler in Network 1 as all boilers in Network 1 will attempt to start before Network 2 boilers are activated. Lead lag setpoint: Network 2 < Network 1 (Default: 2 deg F lower)

WARNING:

This drawing shows suggested control and interface configuration.

DESIGNED	May 26 2011	CAMUS HYDRONICS LIMITED Honeywell SOLA Lead Lag Operation Up to 9 Boilers
CHECKED		
ISA		
RF-C		
This drawing is the property of Camus Hydronics Limited. This drawing may not be used/copied without Camus's prior written consent.		DRAWING NO 99-0220
SIZE	A	REV 00
PROJECT Honeywell SOLA Lead Lag Operation Up to 9 Boilers		SHEET 1 OF 1

HONEYWELL SOLA LEAD LAG OPERATION UP TO 12 BOILERS

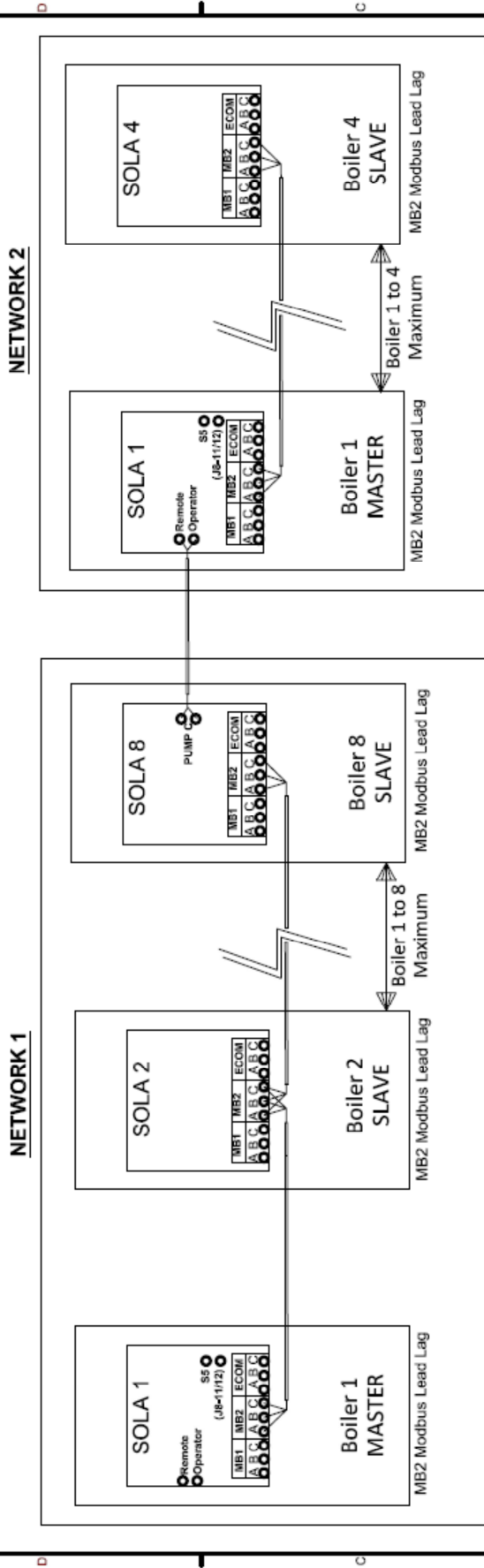

Sensor Wiring:

Each Network must have independent S5 (Lead Lag) sensors and they must be positioned closely together in building piping and wired to respective SOLA 1. Each Network must have independent S5 (Outdoor) sensors and they must be wired to respective SOLA 2 (if applicable).

Operation:

Network 1 supports up to 8 boilers operating in lead lag with SOLA 1 acting as the master. Based on Lead Lag sensor this will govern if additional boilers in Network 1 is required. Refer to I&O Manual for additional details on lead lag operation within a single network.
 Network 2 supports up to a maximum of 4 boilers operating in lead lag.
 Network 1 SOLA 8 Pump C contacts are wired to Network 2 SOLA 1 Remote Operator Contacts
 Network 1 SOLA 8 activates Network 2 SOLA 1 through the use of Pump C contact on R7910A1001. Pump C is activated on a time delay algorithm, where the timer is initiated when SOLA 8 begins ignition sequence.
 Pump C Time Delay (Register #293) = Interstage Delay (Default: 2 mins) x Number of Boilers
 Network 2 operates independently of Network 1.

Note:

Due to rotation of leaders in Network 1; SOLA 8 may become lead boiler. Operation is not impacted regardless of lead boiler in Network 1 as all boilers in Network 1 will attempt to start before Network 2 boilers are activated.
 Lead lag setpoint: Network 2 < Network 1 (Default: 2 deg F lower)

WARNING:

This drawing shows suggested control and interface configuration.

DESIGNED	May 26 2014
CHECKED	
DATE	
BY	
PROJECT	
CAMUS HYDRONICS LIMITED	
Honeywell SOLA Lead Lag Operation Up to 12 Boilers	
SIZE	99-0219
REV	00
SHEET 1 OF 1	

This drawing is the property of Camus Hydronics Limited. This drawing may not be used or copied without Camus's prior written consent.

CONDENSING BOILER LIMITED WARRANTY

GENERAL

Camus® Hydronics Limited (“Camus®”) extends the following LIMITED WARRANTY to the owner of this appliance, provided that the product has been installed and operated in accordance with the Installation Manual provided with the equipment. Camus® will furnish a replacement for, or at Camus® option repair, any part that within the period specified below, shall fail in normal use and service at its original installation location due to any defect in workmanship, material or design. The repaired or replacement part will be warranted for only the unexpired portion of the original warranty. This limited warranty does not cover failures or malfunctions resulting from: (1) Failure to properly install, operate or maintain the equipment in accordance with Camus®’ manual; (2) Abuse, alteration, accident, fire, flood, foundation problems and the like; (3) Sediment or lime build-up, freezing, or other conditions causing inadequate water circulation; (4) Pitting and erosion caused by high water velocity; (5) Failure of connected systems devices, such as pump or controller; (6) Use of non-factory authorized accessories or other components in conjunction with the system; (7) failing to eliminate air from, or replenish water in, the connected water system; (8) Chemical contamination of combustion air or use of chemical additives to water; (9) Production of noise, odours, discolouration or rusty water; (10) Damage to surrounds or property caused by leakage or malfunction; (11) All labour costs associated with the replacement and/or repair of the unit; (12) Any failed component of the hydronic system not manufactured as part of the boiler.

HEAT EXCHANGER

Within 10 years of the appliance having declared FOB from Camus®, a heat exchanger shall prove upon examination by Camus® to be defective in material or workmanship, Camus® will exchange or repair such part or portion if deemed warranty based on the number of years the appliance has been in service.

Years In Service	Dynaforce®	Years In Service	Dynaforce®
1	100%	6	100%
2	100%	7	100%
3	100%	8	100%
4	100%	9	100%
5	100%	10	100%

The exchanged or repaired heat exchanger will carry the balance of the remaining original warranty provided with the appliance based on the FOB date. In the event a replacement heat exchanger is delivered and if the defective heat exchanger is deemed to be repairable by Camus® the repaired heat exchanger will be returned to the customer and a credit will not be issued. Heat Exchanger shall be warranted for (20) years of the appliance having declared FOB from Camus® against “Thermal Shock” (excluded, however, if caused by appliance operation at large changes exceeding 150°F between the water temperature at inlet and appliance temperature or operating at temperatures exceeding 210°F (DRH & DRW).

BURNER

If within FIVE years of the appliance having declared FOB from Camus® to be defective in material or workmanship, Camus® will exchange or repair such part or portion.

ANY OTHER PART

If any other part fails within one (1) year after installation, or eighteen (18) months of the appliance having declared FOB from Camus® whichever comes first Camus® will furnish a replacement or repair that part. Replacement parts will be shipped FOB our factory.

DURATION OF LIMITED WARRANTY

Any limited warranty, including the warranty of merchantability imposed on the sale of the boiler under the laws of the state or province of sale are limited in duration to one year from date of original installation.

STATE LAW & LIMITED WARRANTY

Some states or provinces do not allow:

- a. Limitations on how long an implied warranty lasts
- b. Limitations on incidental or consequential damages.

The listed limitations may or may not apply to you. This warranty gives you specific legal rights, and you may also have other rights which may vary from state to state and province to province.

CONDITIONS

We will not:

- a) Repair or replace any boiler, or part, subject to conditions outlined in ‘This Limited Warranty Does Not Cover’
- b) Reimburse any costs associated with repair and/or replacement
- c) Replace and/or repair any boiler without complete model number/serial number
- d) Replace any boiler without prior receipt of actual rating plate from the appliance.

HOW TO MAKE A CLAIM

Any claim under this warranty shall be made directly to Camus® Hydronics Limited Canadian Head Office

SERVICE LABOR RESPONSIBILITY

Camus® shall not be responsible for any labour expenses to service, repair or replace the components supplied. Such costs are the responsibility of the owner.

DISCLAIMERS

Camus® shall not be responsible for any water damage. Provisions should be made that in the event of a water/appliance or fitting leak, the resulting flow of water will not cause damage to its surroundings.



Name of Owner			
Name of Dealer			
Address			
Model No.			
Serial #:			
Date of Installation:		Date of Initial Operation:	

6226 Netherhart Road, Mississauga, Ontario, L5T 1B7, CANADA

CAMUS® Hydronics is a manufacturer of replacement parts for most copper finned

water heaters and heating boilers as well as a

supplier of specialty HVAC products. Our service line is open 24 hours, 7 days a week!

The CAMUS® CERTIFIED! Seal assures you that Reliability, Efficiency & serviceability are built

into every single unit! For more information



on our innovative products from CAMUS® Hydronics Limited, call 905-696-7800 today.



CAMUS® HYDRONICS LTD.

6226 Netherhart Road, Mississauga, Ontario L5T 1B7

TEL: 905-696-7800 FAX: 905-696-8801

www.Camus@-hydronics.com