

# INSTALLATION OPERATION AND SERVICE MANUAL MODULATING MICROFLAME SERIES 2



## GAS FIRED COMMERCIAL COPPER TUBE BOILERS

### FOR HYDRONIC HEATING

*Non-Condensing Models; MFH800, 1000, 1200, 1400, 1600, 1800, 2000*

*Condensing Models; MFH802, 1002, 1202, 1402, 1602, 1802, 2002*

### HOT WATER SUPPLY

*Non-Condensing Models; MFW800, 1000, 1200, 1400, 1600, 1800, 2000*

*Condensing Models; MFW802, 1002, 1202, 1402, 1602, 1802, 2002*



**WARNING:** If the information in these instructions is not followed exactly, a fire or explosion may result causing property damage, personal injury or death

- Do not store or use gasoline or other flammable vapours and liquids in the vicinity of this or any other appliance.
- **WHAT TO DO IF YOU SMELL GAS**
  - Do not try to light any appliance,
  - Do not touch any electrical switch; do not use any phone in your building,
  - Immediately call your gas supplier from a neighbour's phone. Follow the gas supplier's instructions,
  - If you cannot reach your gas supplier, call the fire department.
- Qualified installer, service agency or the gas supplier must perform installation and service.

To the installer: After installation, these instructions must be given to the end user or left on or near the heater.

To the End User: This booklet contains important information about this heater. Retain for future reference.

## **CAMUS HYDRONICS LTD.**

6226 Netherhart Road, Mississauga, Ontario, L5T 1B7



## Table of Contents

1	GENERAL INFORMATION.....	5
2	LOCATION.....	5
3	PROVIDE AIR FOR COMBUSTION AND VENTILATION.....	7
4	ELECTRICAL WIRING.....	7
5	MODULATION SEQUENCE.....	7
6	NORMAL GAS SUPPLY AND PIPING.....	8
7	VENTING.....	9
7.1	OUTDOOR VENTING.....	11
7.2	SIDEWALL VENTING.....	11
7.3	OUTDOOR AIR KIT.....	11
7.4	FILTER KIT.....	11
7.5	STANDARD VENTING.....	11
7.6	VENTING FOR CONDENSING APPLICATION.....	12
8	ACCESSORIES.....	12
8.1	WATER FLOW SWITCH (shipped loose).....	12
8.2	LOW WATER CUTOFF (If Equipped).....	12
8.3	RELIEF VALVE (shipped loose).....	12
8.4	BOILER APPLICATION (HYDRONIC HEATING).....	13
8.5	WATER HEATER APPLICATION (HOT WATER SUPPLY).....	13
9	FREEZE PROTECTION.....	13
10	WARNING REGARDING CHILLED WATER SYSTEMS.....	14
11	PIPING OF BOILER TO SYSTEM.....	14
12	PLACING BOILER IN OPERATION.....	15
13	IGNITION SYSTEM SAFETY SHUT-OFF DEVICE.....	15
14	LOW WATER TEMPERATURE SYSTEMS.....	15
15	INSTANTANEOUS WATER HEATER.....	16
16	CONDENSER HEAT RECOVERY MODULE (CHRM).....	16
17	INSTRUMENTATION AND CONTROLS.....	19
17.1	SAFETY CONTROLS.....	19
17.2	CONTROL PANEL.....	19
17.3	SETTING THE APPLIANCE TEMPERATURE CONTROLLER.....	20
17.4	MODES OF OPERATION.....	20
17.5	TYPICAL FACTORY SETTINGS OF PARAMETERS FOR MICROFLAME GRANDE BTC 1 (78-0017).....	25
18	MICROFLAME SERIES 2 CONTROL PANEL.....	26
18.1	GENERAL SYMBOL DESCRIPTION.....	26
18.2	MODE 1 & 2: SETPOINT OPERATION: VIEW DISPLAY.....	27
18.3	MODE 1 & 2: SETPOINT OPERATION: ADJUST DISPLAY.....	28
18.4	MODE 3: DEDICATED DOMESTIC HOT WATER OPERATION: VIEW DISPLAY.....	29
18.5	MODE 3: DEDICATED DOMESTIC HOT WATER OPERATION: ADJUST DISPLAY.....	30
18.6	MODE 4 & 5: OUTDOOR RESET OPERATION: VIEW DISPLAY.....	31
18.7	MODE 4 & 5: OUTDOOR RESET OPERATION: ADJUST DISPLAY.....	32
18.8	MODE 6 & 7: EXTERNAL TARGET TEMPERATURE INPUT OPERATION: VIEW DISPLAY.....	33
18.9	MODE 6 & 7: EXTERNAL TARGET TEMPERATURE INPUT OPERATION: ADJUST DISPLAY.....	34
18.10	MODE 8: EXTERNAL DRIVE OPERATION: VIEW DISPLAY.....	35
18.11	MODE 8: EXTERNAL DRIVE OPERATION: ADJUST DISPLAY.....	36
18.12	ERROR MESSAGES.....	36

19 PILOT AND MAIN BURNER FLAMES ..... 38  
19.1 MAIN BURNER ..... 38  
19.2 REMOVAL OF COMBUSTION CHAMBER LINING ..... 39  
19.3 PILOT BURNER ..... 40  
20 OPERATION AND SERVICE ..... 40  
20.1 PRE-START CHECKLIST ..... 40  
20.2 START-UP ..... 40  
20.3 SERVICE..... 44  
21 LIGHTING INSTRUCTIONS ..... 44  
22 TROUBLE SHOOTING GUIDE ..... 45  
23 TYPICAL GAS TRAIN ..... 46  
24 ELECTRICAL DIAGRAMS ..... 47  
24.1 MF 800 - 2000 INTERNAL WIRING CONNECTION DIAGRAM ..... 47  
25 EXPLODED VIEW ..... 48  
WARRANTY ..... 52

## 1 GENERAL INFORMATION

Camus Hydronics proudly introduces the Modulating MicoFlame Series 2 series of water heaters / hydronic boilers. The Modulating MicoFlame Series 2 is a fan assisted boiler based on a push through design which offers several venting options. Heat output is controlled by an adjustable ratio air/gas control valve. The Modulating MicoFlame Series 2 Models 60 – 1000 are capable of modulating from 100% down to 35% of rated input. MicoFlame Series 2 Models 1200 – 2000 are capable of modulating from 100% down to 40%. These gas-burning appliances are thoughtfully designed for easy operation and maintenance. We are confident that you will come to appreciate the benefits of our product.

The installation of this heater must conform to the requirements of the authority having jurisdiction or, in the absence of such requirements, to the latest or current as amended National Fuel Gas Code, ANSI Z223.1 or current CAN/CGA B149 Installation Codes. All electrical wiring must be done in accordance with the requirements of the authority having jurisdiction or, in the absence of such requirements, with the National Electrical Code, ANSI/NFPA 70 or the Canadian Electrical Code Part I, CSA C22.1 Electrical Code.

Vent installations must be in accordance with Part 7, Venting of Equipment, of the latest or current as amended National Fuel Gas Code, ANSI Z223.1, or Section 7, Venting Systems and Air Supply for Appliances, of the current CAN/CGA B149, Installation Codes and applicable provisions of the local building codes.

When required by the authority having jurisdiction, the installation must conform to the Standard for Controls and Safety Devices for Automatically Fired Boilers, ANSI/ASME CSD-1.

The qualified installer shall instruct the end user in the safe and correct operation of this appliance and shall ensure that the heater is in safe working order prior to leaving the job site.

### WARRANTY

Factory warranty shall apply only when the boiler is installed in accordance with local plumbing and building codes, ordinances and regulations, the printed instructions provided

with it and good industry practices.

Excessive water hardness causing a lime build-up in the copper coils or tubes is not a fault of the boiler. Consult the factory for recommendations for use in hard water areas. Damage to the heat exchanger as a result of scaling or corrosive water conditions in non-warrantable.

Using or storing corrosive chemicals in the vicinity of this boiler can rapidly attack the copper tubes and coils and voids warranty.

The primary heat exchanger of this boiler is intended to operate under non-condensing conditions. Inlet temperatures must be maintained at 110 °F or higher. Warranty is void if the primary heat exchanger is allowed to operate in condensing mode. Damage caused by freezing or dry firing voids warranty.

This boiler is not to be used for temporary heating of buildings under construction.

## 2 LOCATION

Install this boiler in a clean, dry location with adequate air supply and close to a good vent connection. Do not locate this boiler in an area where it will be subject to freezing.

The boiler is suitable for installation on combustible flooring and should be located close to a floor drain in an area where leakage from the boiler or connections will not result in damage to the adjacent area or to lower floors in the structure.

If necessary a suitable drain pan should be installed under the boiler.

If the boiler is installed above the level of the building's radiation system, a low water cutoff device must be installed in the boiler outlet at the time of installation. Some local codes require the installation of a low water cutoff on all systems.

**Table 1: Service Clearances**

TOP:	24"	REAR:	24"
SIDES:	24"	FRONT:	48"

This boiler is suitable for alcove installation with minimum clearances to combustibles as follows:

**Table 2: Clearance to Combustibles**

TOP:	12"
SIDES:	12"
REAR:	12"
VENT:	6"
FLOOR:	0"

For boiler's dimensions see Figure 1 and Table 3

**Figure 1: Appliance Dimensions**

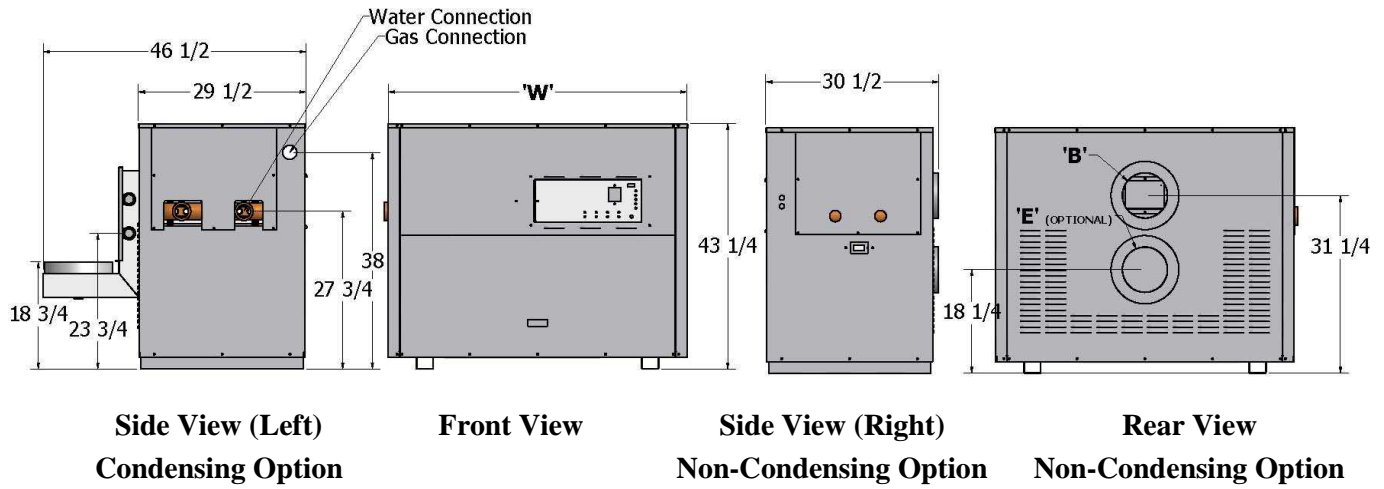

**Table 3: Appliance Dimensions**

Model	W'	Water Connection	Gas Connection	B' Dia. Venting			E' Dia.
				Outdoor	Condensing or Sidewall	Standard	Air Inlet
MF800	45 3/4	2 1/2	1	8	8	10	8
MF1000	52 3/4	2 1/2	1 1/4	8	8	10	8
MF1200	62	2 1/2	1 1/4	10	10	12	10
MF1400	71 1/4	2 1/2	1 1/4	10	10	12	10
MF1600	80 3/4	2 1/2	1 1/2	12	12	14	12
MF1800	89 3/4	2 1/2	1 1/2	12	12	14	12
MF2000	99	2 1/2	1 1/2	12	12	14	12

### **3 PROVIDE AIR FOR COMBUSTION AND VENTILATION**

Provisions for combustion and ventilation air must be in accordance with:

- Section 5.3. Air for combustion and Ventilation, of the latest or the current as amended National Fuel Gas Code, ANSI Z223.1, or;
- Sections 7.2, 7.3 or 7.4 of the latest of the current as amended CAN/CGA B149 Installation Codes, and;
- Applicable provisions of the local building codes.

The operation of exhaust fans, compressors, air handling units etc. can rob air from the room, creating a negative pressure condition leading to reversal of the natural draft action of the venting system. Under these circumstances an engineered air supply is necessary.

If the heater is to be installed near a corrosive or potentially corrosive air supply, the heater must be isolated from it and outside air should be supplied as per code.

Potentially corrosive atmospheres will result from exposure to permanent wave solution, chlorinated waxes and cleaners, chlorine, water softening chemicals, carbon tetrachloride, halogen based refrigerants, Freon cleaning solvents, hydrochloric acid, cements and glues, masonry washing materials, antistatic fabric softeners, dry cleaning solvents, degreasing liquids, printing inks, paint removers, etc.

### **4 ELECTRICAL WIRING**

All electrical wiring to the boiler must be electrically bonded to ground in accordance with the requirements of the authority having jurisdiction or, in the absence of such requirements, with the National Electrical Code, ANSI/NFPA 70 or the Canadian Electrical Code Part I, CSA C22.1, Electrical Code.

Provide disconnecting means of sufficient rating within sight of the boiler. These heaters require an 115V, 60Hz supply. Depending on the pump used, a 15-amp breaker is usually sufficient.

Electrical connections must be made so that the circulator will operate before the gas valve can open. At no time may the control system allow the burner to fire without water flowing in the system.

Use minimum 18-gauge conductor for 24-volt field wiring to boiler. Splicing of wires is not recommended. Use sealed tight conduit suitable for outdoor use for outdoor installations. Use terminal strip provided inside control panel for low water cut-off and remote controller. Refer to wiring diagram provided with boiler.

### **5 MODULATION SEQUENCE**

Before the appliance can light off, all pilots must be lit. Models 800 and 1000 are supplied with a single burner and Models 1200 through 2000 are supplied with two burners.

Each burner is supplied with a dedicated airflow proving switch and separate proved pilot ignition system. All fans must be running in order for the appliance to proceed to trial for ignition.

MicoFlame Series 2 supplied with more than one burner may use burners that are not of identical size in order to accommodate fans within the space allocated. In the case where burners are not identical, the right side burner will be the one with the higher input.

Each MicoFlame Series 2 is supplied with the appropriate wiring diagram showing the sequence provided as well as any special controls or options requested.

When converting multiple MicoFlame Series 2 appliances to an external sequencing control it is absolutely necessary to program the sequencer properly. In this way the sequencer will lead/lag or rotate the boilers properly.

### Pre-purge

BTC 1 Modulation control activates the pre-purge cycle for 20 seconds before trial for ignition.

### Ignition Trial

On proof of air flow, the air proving switch closes and energizes the ignition module. The module first initiates a self check and then starts the pilot ignition sequence. The modulating sequence begins with the modulating fan ramping down to ignition speed. The safety shutoff valve opens, which allows gas to flow to the pilot burner. At the same time, the electronic spark generator in the module produces 10,000 Volt spark pulse output. The voltage generates a spark at the igniter that ignites the pilot. If the pilot does not light, or the pilot flame current is not at least, on average, 1.5  $\mu$ A and steady, the module will not energize the combination valve and the main burner will not light. The ignition module provides 100% gas shutoff, followed by retry for ignition. If required (e.g. CSD-1) a module with lockout feature can be provided.

### Main Burner

When all pilot flames are established, a flame rectification circuit is completed between the sensor and the burner ground. The flame sensing circuit in the ignition module detects the flame current, shuts off the spark generator and energizes the combination valve operator. Once all pilots are lit the main gas valve opens and matches gas input to the available air. As the fans ramp up gas input is adjusted accordingly. On the lock out ignition module, the flame current also holds the safety lockout timer in the reset operating condition. When the call for heat ends, both valve operators are de-energized, and both valves in the gas control close.

### Normal Operation

Modulation is controlled from the Boiler Temperature Controller. The modulating fans are equipped with electrically commutated DC motors which respond to a PWM signal.

The control provided with the Modulating MicoFlame allows remote control with an analog signal of 4-20mA or 2-10VDC.

### Demand Satisfied

The BTC 1 senses that the boiler target temperature was reached and de-energizes the stage contact.

### Control Alarms

High limit or low water flow will de-energize all gas valves, and the blower. Condition indicators are visible on the control panel. Each burner/blower set is provided with its own air pressure switch. If a low air pressure condition is present, power will not be supplied to the ignition module. The blower will remain on and the air indicator will remain on for as long as there is a call for heat. If the safety proving sequence does not proceed to completion, the first safety light to remain off will indicate the cause of the problem. All other lights below the problem indicator light will also remain off.

## 6 NORMAL GAS SUPPLY AND PIPING

This boiler is intended to operate at inlet gas pressures not exceeding 1/4 PSI (7" W.C.) when firing with natural gas. If higher pressures are present, consult the gas company for correction.

When pressure testing the gas supply piping at pressures above 1/2 PSI, the boiler and its individual gas shut-off valve must be disconnected from the supply piping.

Provide a trap (drip leg) as close to the heater as possible.

Install a ground joint union and manual shut-off valve in the gas line near the heater to allow easy removal of the gas control assembly.

Provide gas pressures at inlet to boiler gas train as follows:

**Table 4: Gas Pressure Limits at Inlet to Appliance**

	PROPANE	NATURAL GAS
Min. Running (inches W.C.)	10	4
Maximum (inches W.C.)	11	14

The gas supply line must be of adequate size to prevent undue pressure drop and must never be smaller than the size of the connection on the heater. Sizing based on Table 5 is recommended.

Before operating the boiler, the complete gas train and all connections must be tested using soap solution.



**Table 5: Gas pipe size for distance from natural gas meter or propane second stage regulator**

DISTANCE FROM NATURAL GAS METER OR PROPANE SECOND STAGE REGULATOR						
Input Btu/Hr	0-100 FT		100-200 FT.		200-300 FT.	
	NAT.	L.P.	NAT.	L.P.	NAT.	L.P.
800,000	2"	1 ½"	2 ½"	2"	2 ½"	2"
1,000,000	2"	1 ½"	2 ½"	2"	2 ½"	2"
1,200,000	2 ½"	2"	2 ½"	2"	3"	2 ½"
1,400,000	2 ½"	2"	2 ½"	2"	3"	2 ½"
1,600,000	2 ½"	2"	3"	2 ½"	3"	2 ½"
1,800,000	2 ½"	2"	3"	2 ½"	3"	2 ½"
2,000,000	2 ½"	2"	3"	2 ½"	3"	2 ½"

## 7 VENTING

Boilers for outdoor installation are intended to vent using a listed vent cap.

For indoor installations venting must be in accordance with Part 7, Venting of Equipment, of the latest or current as amended of the National Fuel Gas Code, ANSI Z223.1, or Section 7, Venting of Equipment and Air Supply for Appliances, of the latest or current as amended CAN/CGA B149, Installation Codes, and applicable provisions of the local building codes.

Vent connectors serving appliances vented by natural draft shall not be connected into any portion of mechanical draft systems operating under positive pressure.

Horizontal runs of vent pipe shall be securely supported (approximately every 4 feet) to prevent sagging and maintain a minimum upward slope of ¼" per foot from the boiler to the vent terminal.

When an existing boiler is removed from a common venting system, the common venting system is likely to be too large for proper venting of the appliances remaining connected to it. At the time of removal of an existing boiler, the following steps must be followed with each appliance remaining connected to the common venting system placed in operation, while the other appliances remaining connected to the common venting system are not in operation.

- a) Seal any unused openings in the common venting system.
- b) Visually inspect the venting system for proper size and horizontal pitch and determine that there is no blockage, restriction, leakage, corrosion or other deficiency, which could cause an unsafe condition.
- c) Insofar as is practical, close all building doors and windows and all doors between the space in which the appliances remaining connected to the common venting system are located and other spaces of the building. Turn on the clothes dryers and any appliances not connected to the common venting system. Turn on any exhaust fans, such as range hoods and bathroom exhausts, so they will operate at maximum speed, do not operate a summer exhaust fan. Close fireplace dampers.
- d) Place in operation the appliance being inspected. Follow the lighting instructions. Adjust thermostat so that appliance operates continuously.
- e) Test for spillage at the draft control device relief opening after 5 minutes of main burner operation. Use the flame of a match or candle or smoke from a cigarette.
- f) After it has been determined that each appliance remaining connected to the common venting system properly vents when tested as outlined above, return doors, windows, exhaust fans, fireplace dampers and any other gas-burning appliance to their previous condition of use.

- g) Any improper operation of the common venting system must be corrected so that the installation conforms to the latest or current as amended National Fuel Gas Code, ANSI Z223.1 or the latest or current as amended CAN/CGA B149, Installation Codes. When resizing any portion of the common venting system, the common venting system should be resized to approach the minimum size as determined using the appropriate tables in Part 11 of the latest or current as amended of the National Fuel Gas Code, ANSI Z223, 1 or the latest or current as amended of the CAN/CGA B149, Installation Codes.

Heat exchanger surfaces and vent piping should be checked every six (6) months for deterioration and carbon deposits. Remove all soot or other obstructions from the chimney and flue, which might impede draft action. Replace any damaged or deteriorated parts of the venting system.

A qualified service technician should follow this procedure when inspecting and cleaning the heat exchanger and vent pipe.

1. Turn off electrical power and close main manual gas shut-off and allow boiler to cool down
2. Remove the vent pipe running to chimney. Remove top outer panel and flue collector access panel. Check heat exchanger, vent and chimney for obstruction and clean as necessary.
3. Remove burner from boiler and vacuum heat exchanger. If heat exchanger is excessively dirty it may be necessary to remove it from the boiler and wash it down with proper detergent cleaner. Be aware that the combustion chamber base is insulated with ½" thick ceramic blanket. If this material is damaged or displaced it must be replaced before starting up the boiler.
4. Reinstall parts removed in steps 2 and 3. Be sure that vent pipe has proper pitch and is properly sealed. Repair or replace any gaskets, which may have been damaged in steps 2 and 3.

5. **CAUTION:** When replacing the burner be careful to fully engage the back of the burner box into the retaining slot in the combustion chamber base. Failure to properly locate the burner will result in erratic flame operation with the possibility of delayed ignition on light off.
6. Restore electrical power and gas supply to boiler.
7. Place boiler in operation using lighting instructions provided.
8. While the boiler is operating, check for flue gas leaks and proper vent operation. Seal any flue gas leaks using appropriate gasket or sealing material. Carefully examine the flue collector access panel and heat exchanger ends.

The MicoFlame Series 2 is a category 1, 85% efficient when supplied as a non-condensing appliance. When supplied with the optional condensing cartridge, the MicoFlame Series 2 is 95% efficient and is considered to be a category II or IV appliance. Three venting options are available for this boiler in both condensing and non-condensing configurations. See Figure 2 for details. (Please refer to Table 3 for vent dimensions)

**Figure 2: Venting Arrangement**

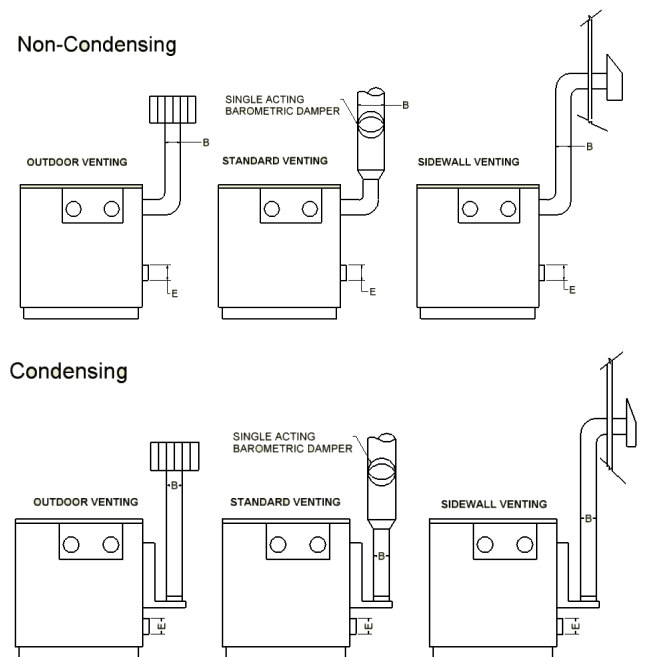

### **7.1 OUTDOOR VENTING**

When fitted with the factory supplied rain shield and UL approved vent cap, the MicoFlame Series 2 is self-venting. The following applies to outdoor installations:

1. Use only factory supplied rain shields.
2. Periodically check to ensure that air intake and vent cap are not obstructed.
3. Locate boiler at least 3 feet away from any overhang.
4. Locate boiler at least ten feet from building air intake.
5. Avoid installation in areas where runoff from adjacent building can spill onto boiler.

### **7.2 SIDEWALL VENTING**

When fitted with the factory supplied vent terminal, the MicoFlame Series 2 can vent up to 60 equivalent feet. Elbows can range from 8 to 15 feet in equivalent length depending on centreline radius. See Table 3 for vent sizes.

Boilers may be installed with either a horizontal sidewall vent or vertical roof top terminal. Terminals differ with each application. Horizontal lengths over 5 feet must be installed using corrosion resistant stainless steel. Use single wall vent and seal all joints or use pressure rated double wall vent.

Refer to local codes for proper installation and location of vent terminals.

When using sidewall vent, all vent connector seams and joints must be sealed with pressure sensitive aluminium tape or silicone sealant as specified by the vent manufacturer. Aluminium tape must meet the provisions of SMACNA AFTS-100-73 Standard.

When venting through unheated spaces with single wall vent, insulation should be wrapped around the vent pipe to prevent flue gas condensation inside the vent.

Periodically check to ensure that the vent terminal is unobstructed.

### **7.3 OUTDOOR AIR KIT**

When fitted with the factory supplied air inlet ring and air intake terminal, the MicoFlame Series 2 can draw outdoor air over an equivalent length of 60 feet. See Table 3 for vent sizes.

Boilers may be installed with either a horizontal sidewall vent or vertical roof top terminal. Terminals differ with each application.

The following applies to outdoor air installations:

1. Use only factory supplied air intake terminal.
2. Periodically check to ensure that air intake is not obstructed.
3. Refer to local codes for proper installation and location of vent terminals. Vertical vent terminal must be at least 3 feet above the highest point where it is located above the roof of a building and at least two feet higher than any part of the building within a horizontal distance of ten feet
4. Locate the air intake five feet away from the vent discharge. For sidewall venting locate the air intake below the vent outlet if possible.

### **7.4 FILTER KIT**

A louvered rear panel is the standard air inlet configuration for the MicoFlame Series 2. A filter kit is available. The filter is washable and accounts for an additional pressure loss of less than 0.05" W.C. Highly recommended for dusty environments.

The filter kit can also be provided when using the outdoor air kit.

### **7.5 STANDARD VENTING**

The non-condensing 85% efficient MicoFlame Series 2 is a category 1 appliance and is approved for venting into a common standard chimney. If chimney height is much greater than 30 feet or if drafts are excessive, it will be necessary to provide a single acting barometric damper directly above the vent collar. This damper will ensure smooth light off and minimize standby loss through the boiler. Be sure to position the damper at least 6" away from the wall of the vent connector.

## 7.6 VENTING FOR CONDENSING APPLICATION

When supplied with the optional condensing cartridge, the MicoFlame Series 2 is 95% efficient (category II or IV appliance) which requires the use of special venting system. Refer to installation instruction No. 93-0152-1. Only venting components listed by a nationally recognized testing agency may be used.

## 8 ACCESSORIES

### 8.1 WATER FLOW SWITCH (*shipped loose*)

A water flow switch is shipped loose and is to be installed in the outlet piping on all heating boilers and hot water supply boilers. The flow switch is wired in Series with the 24VAC safety control circuit. A diagnostic light will be indicated on the control display on a low flow condition.

### 8.2 LOW WATER CUTOFF (*If Equipped*)

If this boiler is installed above radiation level, a low water cut-off device must be installed at the time of boiler installation. Some local codes require the installation of a low water cut-off on all systems. Electronic low water cut-offs are available as a factory supplied option on all models. Low water cut-offs should be tested every six (6) months. The normally open switch contact of the low water cutoff is to be wired in Series with the flow switch. A diagnostic light will be indicated on the control display on a low flow condition. Caution: remove jumper when connecting to 24 VAC circuit.

**Figure 3: Low Water Cutoff Electrical Connections**

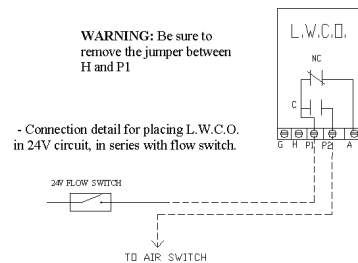

### 8.3 RELIEF VALVE (*shipped loose*)

This appliance is supplied with a relief valve sized in accordance with ASME Boiler and Pressure Vessel Code, Section IV ("Heating Boilers"). The relief valve is to be installed in the vertical position and mounted in the hot water outlet. No valve is to be placed between the relief valve, and the appliance. To prevent water damage, the discharge from the relief valve shall be piped to a suitable floor drain for disposal when relief occurs. No reducing couplings or other restrictions shall be installed in the discharge line. The discharge line shall allow complete drainage of the valve and line. Relief valves should be manually operated at least once a year.

#### **8.4 BOILER APPLICATION (HYDRONIC HEATING)**

In case of boilers (Hydronic heating boiler) application, the return water (supply water) may be more than 130°F (55°C), therefore there is no need for a recirculation loop and the primary heat exchanger and CHRM can be piped in parallel. Since the inlet water temperature to CHRM exceeds 110°F (44°C) it will not condense fully and therefore the CHRM will not perform to its maximum efficiency capacity. If water colder than 130°F (55°C) is available it can be fed to the CHRM.

#### **8.5 WATER HEATER APPLICATION (HOT WATER SUPPLY)**

In case of domestic water supply (Water Heating), the fresh inlet water temperature will be less than 110°F (44 °C), in this case the CHRM may be fed directly with part of the supply water using a secondary pump. A pressure relief valve is supplied as standard equipment. The relief valve protects against damage that could be caused by malfunctioning controls or excessive water pressure. If a relief valve is not used, warranty is void.

The relief valve is to be located as near as practical to the outlet of the boiler. To maintain capacity do not reduce the inlet connection of the relief valve. Connect the outlet of the relief valve to a suitable drain. The drainpipe must point down from the valve and must not be smaller than the outlet of the valve. The end of the drain line should not be concealed or threaded and should be protected against freezing. No valve of any kind should be installed between the relief valve and the unit or in the drain line. Extensive runs, traps or bends could reduce the capacity of the valve. This valve should be checked for proper operation at least once a year by a qualified service technician.

## **9 FREEZE PROTECTION**

- Appliance installations are not recommended outdoors in areas where danger of freezing exists unless precautions are taken. Maintaining a mixture of 50% water and 50% propylene glycol is the preferred method of freeze protection in hydronic systems. This mixture will protect the appliance to approximately -35°F (-37°C). To maintain the same temperature rise across the appliance increase the GPM flow by 15% and the head loss by 20%.

The following example demonstrates the procedure to follow for calculating the revised head for the heat exchanger when using a water / glycol mixture.

- Given for example that Camus is showing a heat exchanger flow and head loss of 100 gpm @ 10 feet
- Increasing the flow by 15% now results in a head loss of 13 feet at 115 gpm (from B&G system syzer). At this increased flow Camus now recommends to increase the head loss by 20%.
- The requirement for the heat exchanger with water / glycol mixture will now be 115 gpm @ 15.6 feet. (ie.  $1.2 \times 13\text{ft.} = 15.6\text{ft.}$ )
- A similar procedure must be followed to calculate the additional head loss in pipe and fittings in order to arrive at the proper pump selection.
- For Outdoor installations a snow screen should be installed to prevent snow and ice accumulation around the appliance. Regular inspections should be made to ensure that air intake and vent are free of snow and ice. Always consider the use of a shelter such as a garden shed in lieu of direct exposure of the appliance to the elements. The additional protection afforded by the shelter will help to minimize nuisance problems with electrical connections and will allow easier servicing of the appliance under severe weather conditions.

## 10 WARNING REGARDING CHILLED WATER SYSTEMS

When a boiler is connected to an air conditioning system where the same water is used for heating and cooling, the chiller must be piped in parallel with the boiler. Appropriate flow control valves; manual or motorized must be provided to prevent the chilled water from entering the boiler. (See Figure 4)

Figure 4: Typical Chilled Water System

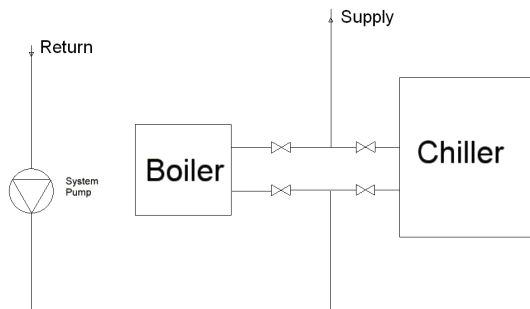

When a boiler is connected to heating coils located in air handling units (where they may be exposed to refrigerated air circulation), the boiler piping system shall be equipped with a flow control valve or other automatic means to prevent gravity circulation of chilled water through the boiler. Chilled water in the boiler will create condensate on the boiler tubes, which will collect in the combustion chamber causing corrosion.

## 11 PIPING OF BOILER TO SYSTEM

Check all applicable local heating, plumbing and building safety codes before proceeding.

Be sure to provide unions and gate valves at inlet and outlet to boiler so that it can be easily isolated for service.

This boiler is of a low mass design, which provides for instant heat transfer. Special attention to water flow rates will ensure that temperature rise does not exceed 35°F (19.4°C). The following table 6 is provided as a guide.

For application in areas known to have hard water conditions, contact factory for recommendations.

Table 6: Flow and Pressure Drop at a Given Temperature Rise

Head Loss and Flow Vs Temperature Rise

Model	20 °F		30 °F		35 °F	
	USGPM	ΔP ft.	USGPM	ΔP ft.	USGPM	ΔP ft.
800	66.6	2.8	44.4	1.1	38.0	0.8
1000	83.3	4.9	55.5	2.0	47.6	1.5
1200	100.0	6.9	66.7	3.1	57.1	2.4
1400	*	*	77.8	4.3	66.7	3.4
1600	*	*	88.9	5.4	76.2	4.0
1800	*	*	100.0	6.9	85.7	5.1
2000	*	*	*	*	95.2	6.2

\* Contact factory for recommendations

Figure 5: Typical Boiler Piping to System

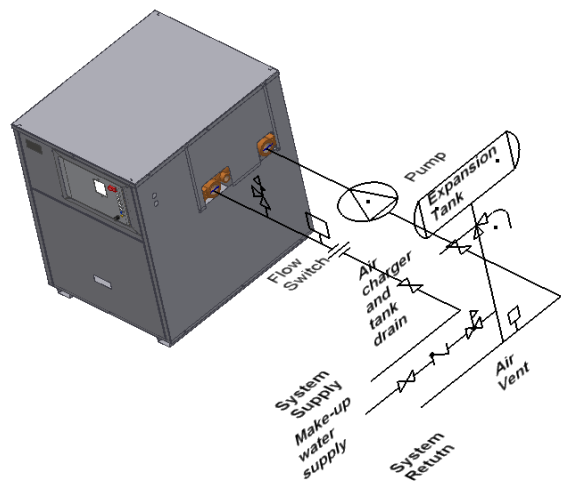

If the boiler is installed above radiation level, it must be provided with a low water cutoff device at the time of boiler installation. (Available from factory)

To eliminate trapped air, install venting devices at high points in the system as well as in the piping on the suction of the pump and in the piping on the discharge of the boiler.

Suitable pipe hangers must support the weight of all water and gas piping or floor stands.

Do not allow the boiler to run with inlet water temperature below 130°F (55°C).

The boiler must be installed so that the gas ignition system components are protected from water (dripping, spraying, rain, etc.) During appliance operation and service (circulator replacement control replacement, etc.)

## 12 PLACING BOILER IN OPERATION

The MicoFlame Series 2 boiler should be installed and started up by qualified personnel.

With the boiler off, open makeup water valve and allow system to fill slowly. Adjust the pressure regulator to provide at least 15 PSIG in the system when cold.

With all air vents open, run system circulating pump for a minimum of 30 minutes with the boiler off.

Open all strainers in the circulating system and check for debris.

Check liquid level in expansion tank. With system full of water at 15 PSIG, the level of water in the expansion tank should not exceed  $\frac{1}{4}$  of the total volume with the balance filled with air.

Start up boiler following instructions provided. Operate entire system including pumps and radiation for at least 1 hour.

Check water level in expansion tank. If level exceeds  $\frac{1}{2}$  of tank volume, air is still trapped in system. Shut down boiler and continue to run pumps.

Within 3 days of start up, recheck all air vents and expansion tank as described above.

## 13 IGNITION SYSTEM SAFETY SHUT-OFF DEVICE

After initial fill while the main burner is firing, shut off gas to the pilot and clock the time taken for the main gas valve to shut down. If the safety control is functioning properly, power to the gas valve will be shut off within 4 seconds of the pilot gas being shut off. If shut down takes longer, ignition control or gas valve may be defective.

## 14 LOW WATER TEMPERATURE SYSTEMS

In applications where the heating system requires supply water temperatures below 130°F (55°C), a bypass line must be installed upstream of the boiler pump so that outlet water can be re-circulated to raise the inlet temp to a minimum of 130°F (55°C). Balancing valves, preferably globe valves are used to adjust flow. (See Figure 6)

**Figure 6: Low Water Temperature System**

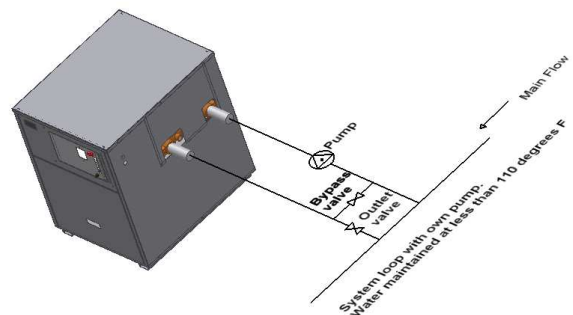

- Adjustment procedure.
  - a. Fully open bypass and outlet valves.
  - b. With boiler running, read inlet temperature after 15 minutes.
  - c. If the inlet temperature is less than 130°F (55°C) slowly close outlet valve until the inlet temperature climbs to 130°F (55°C)
  - d. If the inlet temperature is greater than 130°F (55°C) but not greater than 140°F (60°C) no further adjustment is required.
  - e. Check the inlet temperature after 5 minutes and make final adjustments.

## 15 INSTANTANEOUS WATER HEATER

An instantaneous water heater is designed to deliver hot water without the use of a storage tank. It is suitable for applications with variable load such as restaurants, condominiums, apartments and motels. (See Figure 7) Call factory for recommendations.

**Figure 7: Instantaneous Water Heater Suggested Piping**

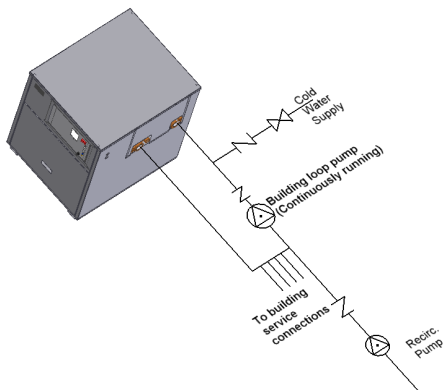

## 16 CONDENSER HEAT RECOVERY MODULE (CHRM)

The MicoFlame Series 2 All Stainless Steel CHRM is mounted in a stainless steel inner jacket chamber at the rear of the appliance. The CHRM is constructed from all stainless steel headers and special multiple horizontal stainless tubes. This CHRM is designed to maximize heat transfer efficiency by fully condensing flue products and is suitable to resist the low pH of condensate.

The CHRM must be supplied with adequate water flow at all times during operation. Do not operate the appliance with the CHRM piped out or isolated.

The CHRM is mounted in the discharge of the flue products from the primary heat exchanger. This allows additional heat to be absorbed from the flue products exhausted from the combustion process. If isolation valves are provided on the CHRM, the provision of a relief valve at the outlet of the CHRM is recommended. This valve is to be sized at minimum for 10% of the input of the appliance and is to be piped to drain.

When cold water supply with temperatures less than 110°F (44°C) passes through the CHRM it will cool the flue products below dew points resulting in the formation of condensation. Furthermore, the volumetric flow rate of the flue gases will be reduced.

The appliance CHRM loop may be used in condensing mode for a variety of application including domestic hot water and hydronic space heating. Recommended piping arrangement is shown in Figure 8. Maximum capacity through the CHRM is summarized in Table 7; flows in excess of 60 GPM must be bypassed.

**Figure 8: Typical Condensing System**

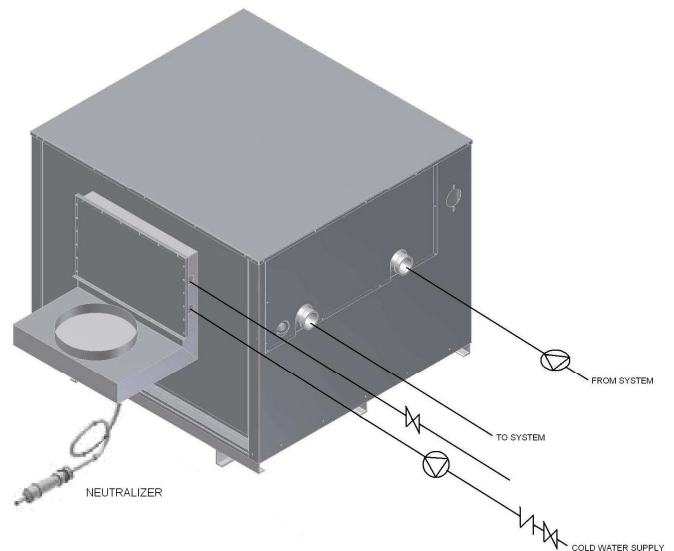

Condensate from the MicoFlame Series 2 must be treated before being discharged to drain. pH level of the condensate is to be checked regularly and the neutralizing medium is to be replaced as required. A neutralizing cartridge is available from the factory. The condensing MicoFlame Series 2 must be vented using only special venting type AL29-4C stainless steel or equivalent, please follow instructions detailed below.

When supplied with the CHRM, the MicoFlame Series 2 is 95% efficient (category II or IV appliance) which requires the use of a special venting system fabricated from AL29-4C or equivalent material. Only venting components listed by a nationally recognized testing agency may be used.



This appliance may be installed with conventional, sidewall or vertical venting. Conventional vented appliances operate with negative pressure in the vent pipe and require a special vent adapter to increase the flue outlet diameter. Sidewall and vertically vented appliances operate with positive pressure in the vent pipe and may be directly connected to the flue outlet without the use of an increaser.

Consult the vent pipe manufacturer's instructions for minimum clearances to combustible material for vent components. In the absence of instructions, the minimum clearance to combustible material is six inches.

Consult vent pipe manufacturer's instructions for proper method of sealing vent pipe sections and fittings. In the absence of instructions, make sure that pipe and fittings are clean by swabbing with alcohol. Use Dow Corning 736 or 732 RTV, Polybar # 500 RTV or Sil-bond 4500 or 6500 to seal vent pipe. Do not use other sealants or adhesives except as expressly permitted by vent manufacturer's instructions.

Consult vent pipe manufacturer's instructions for vent system assembly. Follow vent pipe manufacturer's instructions if those instructions differ from this section.

**Figure 9: Secondary Heat Exchanger**

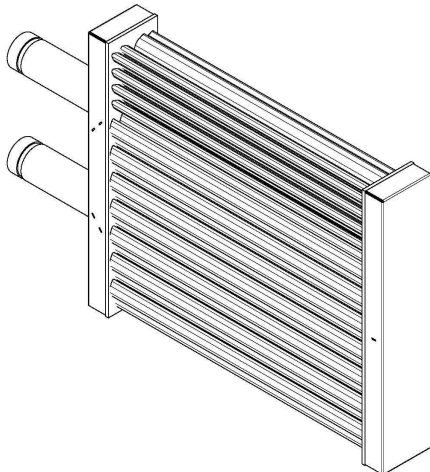

**Table 7: CHRM Head Loss & Flow**

Model	US GPM	ΔP - Ft.
800	16.0	1.0
1000	20.0	1.5
1200	24.0	2.0
1400	28.0	2.7
1600	32.0	3.5
1800	36.0	4.5
2000	40.0	5.5

A neutralizer cartridge is provided and must be installed in the line from the condensate collection pot to the drain. pH level of the condensate is to be checked regularly and neutralizing medium is to be replaced as required to maintain effectiveness. A neutralizer cartridge is available from the factory.

**CONDENSING HEAT RECOVERY MODULE PIPING CONFIGURATIONS**

Caution: If isolation valves are provided on the CHRM, the provision of a relief valve at the outlet of the secondary is recommended. This valve is to be sized at minimum for 10% of the input of the appliance and is to be piped to drain in a manner similar to the appliance relief valve.

**CHRM IN SERIES WITH PRIMARY HEAT EXCHANGER (INTEGRATED LOOP)**

The MicoFlame could be provided in condensing mode for a variety of application including domestic hot water and hydronic space heating.

The CHRM is intended to extract total (sensible and latent) heat from the flue gases downstream of the primary heat exchanger. As a result, condensation of moisture in the flue gas will take place on the CHRM surfaces and in the exhaust vent. This condensation is a natural outcome when efficiencies exceed 90%.

Recommended installation methods of the condensing MicoFlame will vary depending on the application and the expected water temperature variation of the system.

Examples of recommended installation for typical applications are shown on the next page:

**Figure 10: Hydronic Heating Suggested Piping with CHRМ**

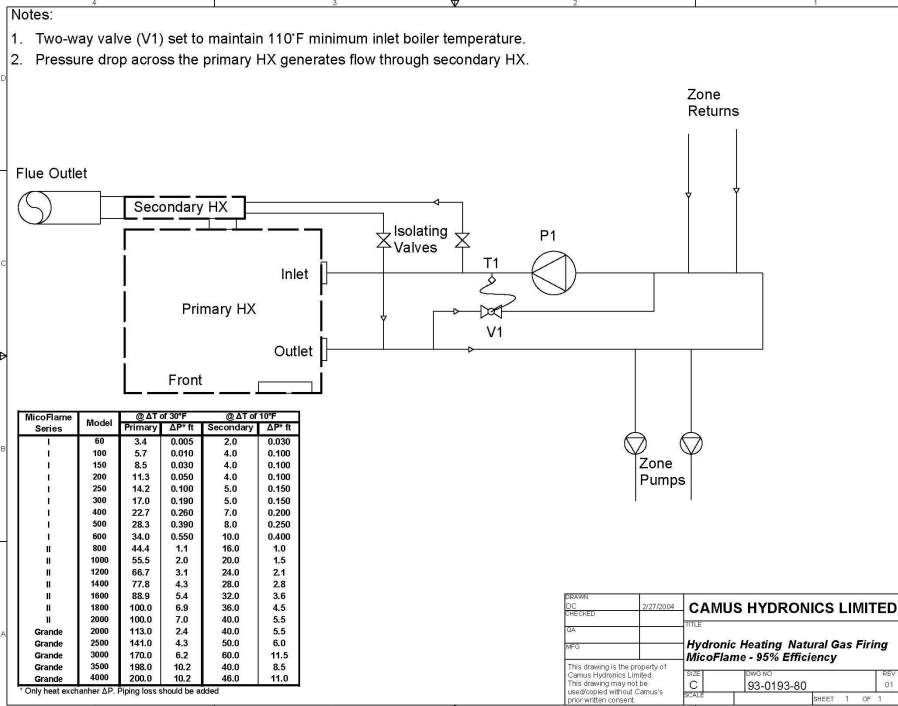

**Figure 11: Domestic Hot Water Suggested Piping with CHRМ**

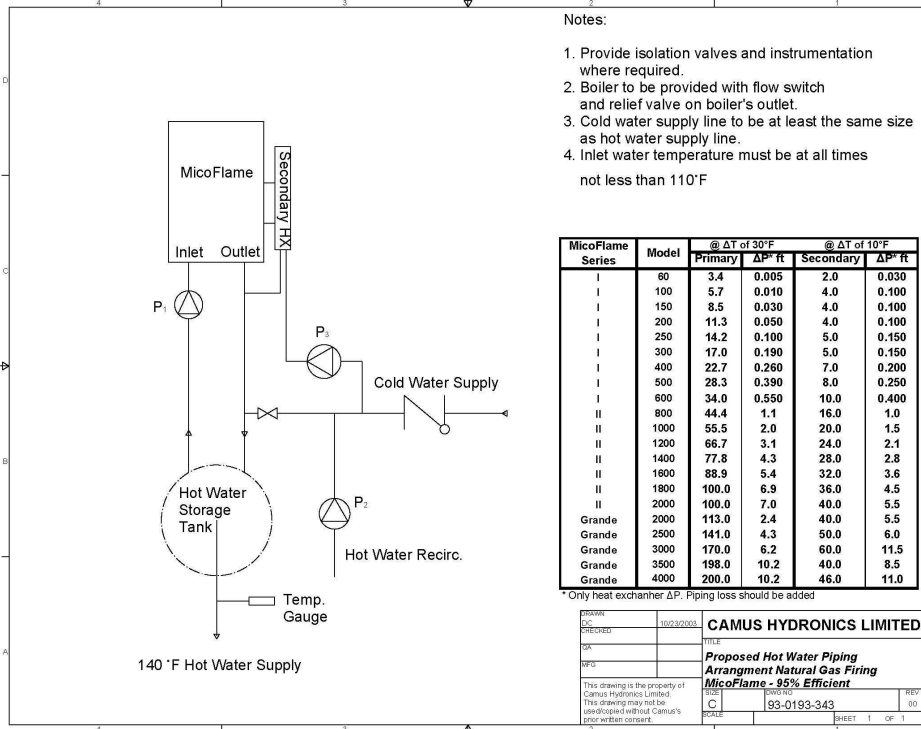

## 17 INSTRUMENTATION AND CONTROLS

### 17.1 SAFETY CONTROLS

#### High Temperature Limit

The high temperature limit is located behind the appliance's access doors. A remote capillary bulb runs to a thermo-well on the outlet side of the inlet/outlet header. The appliance high limit is set at the factory to 210°F for hot water and 230°F for heating.

#### Air Flow Switch

A differential air pressure switch is provided to prove the operation of the fan and adequate air flow to the burner. The pressure switch sensing point is at the inlet to the mixing tube where the air and gas mixes. The LED indicator for air flow will not illuminate should the pressure switch detect a sustained low air condition. The appliance is provided with one air switch per burner module.

### 17.2 CONTROL PANEL

The appliance is provided with a control panel at the front. Operating controls are installed inside the control box and are accessible by undoing the thumb screw and opening the door. The diagnostic information centre as well as the on/off switch, 24V fuse, and the appliance temperature controls reside on the control panel door.

**Figure 12: Display, Appliance Temperature Controller and Indicating LED**

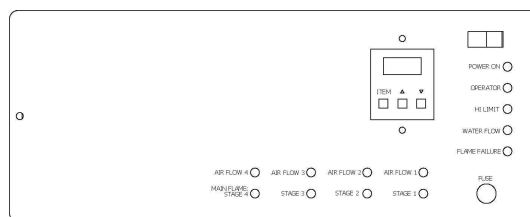

The Boiler Temperature Controller (BTC 1) for this appliance is a Camus 780014 SmartFlame control. The BTC 1 uses a Liquid Crystal Display (LCD) as a method of displaying boiler information. The BTC 1 is used to setup and monitor the operation of the system. The BTC 1 uses three push buttons for selecting and adjusting settings.

#### Boiler Temperature Controller Features:

It initiates the local call for heat and sets the target inlet (appliance inlet) water temperature. This controller accommodates heating and domestic hot water control with multiple modes of operation which provide set point as well as reset control. It provides the following:

- Readings of inlet and outlet temperatures and  $\Delta T$  temperature rise
- Operation as an auto reset limit.
- Operation as a control for inlet water temperature.
- Optional tank mounted sensor used in conjunction with inlet sensor.
- Adjustable pump delay feature based on  $\Delta T$  temperature difference between inlet and outlet temperatures. Accepts 1/6 hp. pump directly across terminals 13 & 14.
- Adjustable; target temp
- Display of run hours for maintenance purposes. Counter wraps around at 1000 hours.
- Flame failure signal 24 V.
- Molex connector for ease of service.
- Error message display.
- Test override feature to test pump operation and alarm.
- Pump exercising feature runs pump 10 seconds every three days of no pump operation.

The menu structure for the Appliance Temperature Control was designed to be intuitive and easy to use for a first time user. To maintain the MicoFlame Modulating boiler at its correct settings two levels of access is provided, User and Installer with an increasing amount of parameters that can be adjusted by the Installer. This is done to provide an easy means of communication for the end user and a more indepth approach for factory installers when installing and troubleshooting.

**Figure 13: Boiler Temperature Control (BTC 1)**

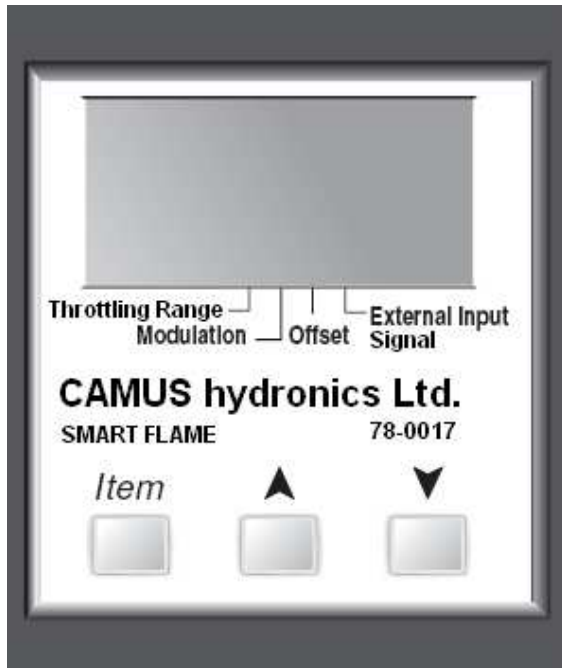

**17.3 SETTING THE APPLIANCE TEMPERATURE CONTROLLER**

Press and hold all three buttons (Item, ▲, ▼) simultaneously for 1 second. Pressing the ITEM key again will cause the last setting to be accepted. Once all settings have been made wait for 30 seconds for the BTC 1 to return to normal operating mode. To re-enter the Installer menu press and hold all three buttons (Item, ▲, ▼) simultaneously for 1 second. In normal operating mode the inlet temperature, outlet temperature, ΔT temperature and ON hours can be viewed by repeatedly pressing the ITEM key. If you wish to check the setting you will have to start again by pressing and holding the (Item, ▲, ▼) buttons simultaneously for 1 second, and then use the ITEM key to scroll through the settings. After checking the settings allow the BTC 1 to return to normal operation on its own.

**17.4 MODES OF OPERATION**

Mode 1: Constant Temperature Control

This mode is designed for hydronic heating or domestic hot water (DHW). Once a heat demand is present, the BTC 1 turns on the appliance pump and modulates the boiler burner to maintain the boiler target at the boiler inlet sensor. A heat demand is generated when a 24VAC is applied across CD (common demand) and Ht D (heat demand). Once voltage is applied, the BTC 1 turns on the Dem 1 segment in the display.

If the inlet sensor is ½ (half) of the differential below the BOIL TARGET, the BTC 1 then changes the proportional modulation output to the START modulation setting, the Stage contact (pins 15 & 16) close to proceed to trial for ignition. The burner remains at minimum modulation until the flame is proved and then the modulating output changes the boiler burner output to maintain the programmed boiler target temperature at the inlet sensor. If the inlet sensor reaches ½ (half) of the differential above BOIL TARGET setting, the burner shuts off. Once the external heat demand is removed, the BTC 1 turns off the appliance and operates the boiler pump based on the PUMP DELAY setting.

The water temperature is controlled based on a fixed setpoint (BOIL TARGET). The setpoint for inlet water is pre-set to 130°F and the auto re-set limit is set to 210°F and is fixed. In addition to the auto reset limit the factory installs a manual re-set limit set to 250°F.

**Figure 14: Mode 1 Piping & Electrical Layout**

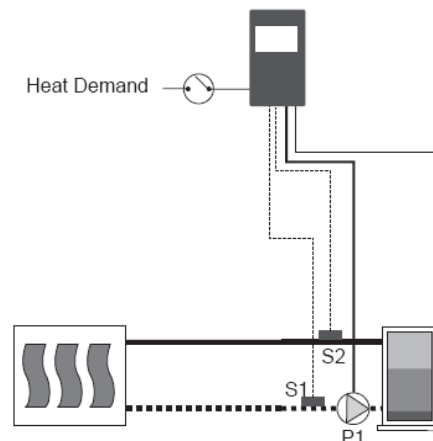

**Mode 2: Constant Temperature Control at System Sensor**

This mode is designed for hydronic heating. Once a heat demand is present, the BTC 1 modulates the boiler burner to maintain the boiler target at the system sensor. A heat demand is generated when 24VAC is applied across CD (common demand) and Ht D (heat demand). Dem 1 on the LCD display is lit.

If the system sensor is ½ (half) of the differential below the BOIL TARGET, the BTC 1 then changes the proportional modulation output to the START modulation setting, the Stage contact (pins 15 & 16) closes to proceed to trial for ignition. The burner remains at minimum modulation until the flame is proved and then the modulating output changes the boiler burner output to maintain the programmed boiler target temperature at the system sensor. If the system sensor reaches ½ (half) of the differential above BOIL TARGET setting, the burner shuts off. Once the external heat demand is removed, the BTC 1 turns off the appliance and operates the boiler pump based on the PUMP DELAY setting. In this case, it is imperative that the system pump operates continuously in order to provide constant circulation past the system sensor.

The water temperature is controlled based on a fixed setpoint (BOIL TARGET). The setpoint for inlet water is pre-set to 130°F and the auto re-set limit is set to 210°F and is fixed. In addition to the auto reset limit the factory installs a manual re-set limit set to 250°F.

**Figure 15: Mode 2 Piping & Electrical Layout**

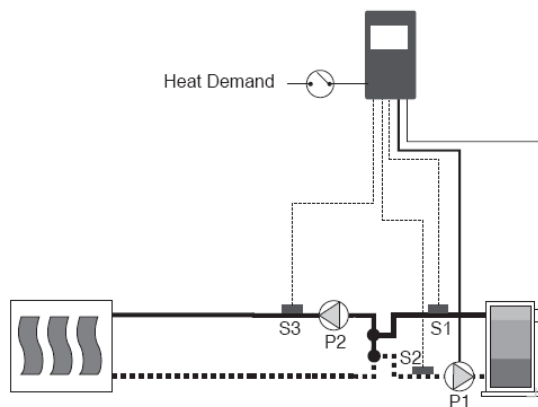

**Mode 3: Dedicated Domestic Hot Water Operation**

This mode is designed for domestic hot water. A DHW sensor must be inserted into a temperature immersion well within the DHW tank to function properly. The BTC 1 modulates the boiler based on the boiler inlet sensor to maintain a tank temperature at the DHW sensor.

An internal heat demand is generated when the DHW sensor drops ½ (half) of the tank differential setting below the desired DHW tank temperature. Dem 1 is lit on the LCD screen.

The BTC 1 then changes the modulation output to the START modulation setting and closes the Stage contact (pins 15 & 16) to proceed to trial for ignition. The burner remains at minimum modulation until the flame is proved and then modulating output changes the boiler output to maintain the programmed boiler target temperature at the boiler inlet sensor. Once the DHW tank reaches ½ of the tank differential above the TANK TARGET setting, the internal demand is removed and the boiler burner is shut off. The pump circulates until the PUMP DELAY timer expires.

The TANK TARGET setting is used to set the desired DHW tank setpoint. The set-point for inlet water is pre-set to 130°F and can be adjusted, the auto re-set limit is set to 210°F and is fixed. In addition to the auto reset limit the factory installs a manual re-set limit set to 210°F.

**Figure 16: Mode 3 Piping & Electrical Layout**

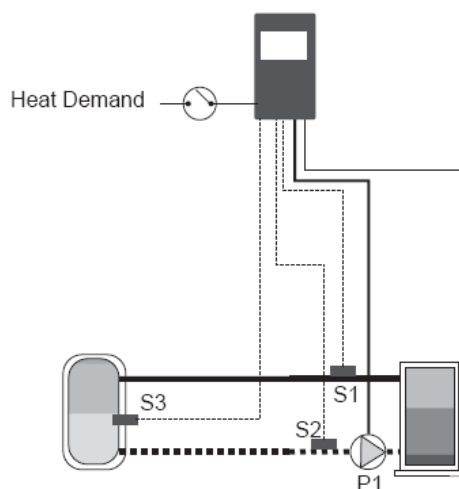

#### Mode 4: Outdoor Reset using Boiler Inlet Sensor

This mode is designed for hydronic heating. Once a heat demand is present, the BTC 1 turns on the appliance pump and modulates the boiler to maintain the calculated outdoor reset target at the boiler inlet sensor. Outdoor reset calculates the boiler target temperature based on the outdoor air temperature and reset ratio.

A heat demand is generated when a voltage between 24VAC and 120VAC is applied across CD (common demand) and Ht D (heat demand). Once voltage is applied, the BTC 1 turns on the Dem 1 segment in the display. If warm weather shut down (WWSD) is activated, the WWSD segment is lit.

If WWSD is not activated and the inlet sensor is  $\frac{1}{2}$  (half) of the differential below the calculated BOIL TARGET, the BTC 1 then changes the modulation output to the START modulation setting and closes the Stage contacts (pins 15 & 16) to proceed to trial for ignition. The burner remains at minimum modulation until the flame is proved and then modulating output changes the boiler output to maintain the calculated boiler target temperature at the inlet sensor. If the inlet sensor reaches  $\frac{1}{2}$  (half) of the differential above the BOIL TARGET, the appliance is shut off. The boiler pump continues to circulate until the PUMP DELAY timer expires.

The water temperature is controlled based on a calculated boiler target temperature. The boiler start (BOIL START) temperature is pre-set to 70°F and the auto re-set limit is set to 210°F and is fixed. In addition to the auto reset limit the factory installs a manual re-set limit set to 250°F.

Figure 17: Mode 4 Piping & Electrical Layout

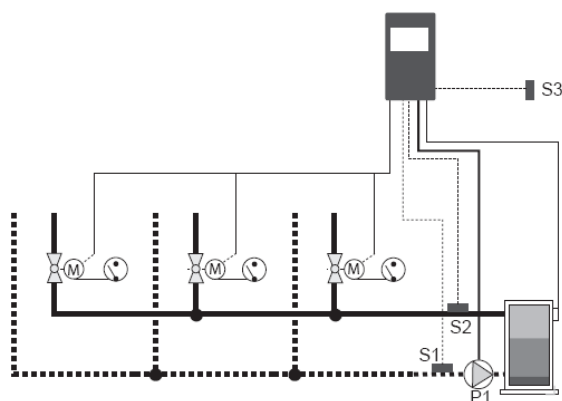

#### Mode 5: Outdoor Reset using System Sensor

This mode is designed for hydronic heating. Once a heat demand is present, the BTC 1 turns on the appliance pump and modulates the boiler to maintain the calculated outdoor reset target at the system sensor. Outdoor reset calculates the boiler target temperature based on the outdoor air temperature and reset ratio.

A heat demand is generated when a voltage between 24VAC and 120VAC is applied across CD (common demand) and Ht D (heat demand). Once voltage is applied, the BTC 1 turns on the Dem 1 segment in the display. If warm weather shut down (WWSD) is activated, the WWSD segment is lit.

If WWSD is not activated and the system sensor is  $\frac{1}{2}$  (half) of the differential below the calculated BOIL TARGET, the control then changes the modulation output to the START modulation setting and closes the Stage contacts (pins 15 & 16) to proceed to trial for ignition. The burner remains at minimum modulation until the flame is proved and then the modulating output changes the boiler output to maintain the calculated boiler target temperature at the system sensor. If the system sensor reaches  $\frac{1}{2}$  (half) of the differential above the BOIL TARGET, the appliance is shut off. The appliance pump continues to circulate until the PUMP DELAY timer expires. In this case, it is imperative that the system pump operates continuously in order to provide constant circulation past the system sensor.

The water temperature is controlled based on a calculated boiler target temperature. The boiler start (BOIL START) temperature is pre-set to 70°F and the auto re-set limit is set to 210°F and is fixed. In addition to the auto reset limit the factory installs a manual re-set limit set to 250°F.

Figure 18: Mode 5 Piping & Electrical Layout

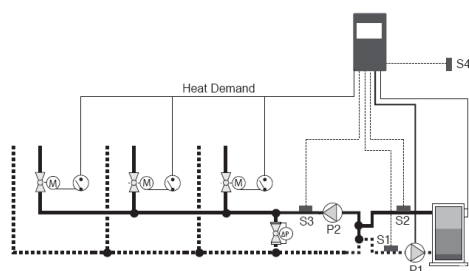

**Mode 6: External Target Temperature using Boiler Inlet Sensor**

The external input signal can be provided from a BMS, EMS or a tekmar tN4 System Control. The external input signal creates an internal demand and changes the boiler target according to a linear scale. The BTC 1 modulates the boiler to maintain the boiler target at the inlet sensor.

An internal heat demand is generated when an analog positive 2-10VDC signal is applied to the +V input and a negative DC signal is applied to the Com/- input.

The following table shows the various signals required to generate various Target temperatures.

**Table 8: External Signal Cross Reference Chart**

4-20 mA	Boiler Target	0-10V (dc)*	Boiler Target
0	--- (OFF)	0	--- (OFF)
2	--- (OFF)	1	50°F (10°C)
4	50°F (10°C)	2	68°F (20°C)
6	70°F (21°C)	3	86°F (30°C)
8	90°F (32°C)	4	103°F (39°C)
10	110°F (43°C)	5	121°F (49°C)
12	130°F (54°C)	6	139°F (59°C)
14	150°F (66°C)	7	157°F (69°C)
16	170°F (77°C)	8	174°F (79°C)
18	190°F (88°C)	9	192°F (89°C)
20	210°F (99°C)	10	210°F (99°C)

\* requires 500Ω resistor

A 4-20mA signal can be converted to a 2-10VDC signal by installing a 500Ω resistor on the external input signal device's terminal.

If the inlet sensor is ½ (half) of the differential below the Boiler Target, the BTC 1 then changes the proportional modulation output to the START modulation setting, the Stage contact (pins 15 & 16) closes to proceed to trial for ignition. The burner remains at minimum modulation until the flame is proved and then the modulating output changes the boiler burner output to maintain the programmed boiler target temperature at the inlet sensor. If the inlet sensor reaches ½ (half) of the differential above Boiler Target, the burner shuts off. Once the

external heat demand is removed, the BTC 1 turns off the appliance and operates the boiler pump based on the PUMP DELAY setting.

The auto re-set limit is set to 210°F and is fixed. In addition to the auto reset limit the factory installs a manual re-set limit set to 250°F.

**Figure 19: Mode 6 Piping Schematic**

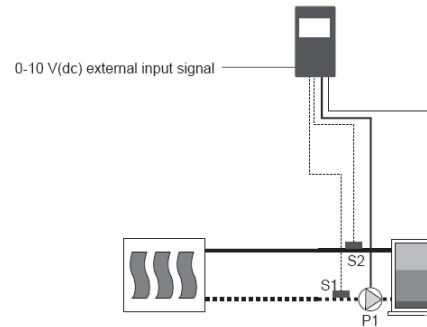

**Mode 7: External Target Temperature using System Temperature Sensor**

The external input signal can be provided from a BMS, EMS or a tekmar tN4 System Control. The external input signal creates an internal demand and changes the boiler target according to a linear scale. The control modulates the boiler to maintain the boiler target at the outlet sensor.

An internal heat demand is generated when an analog positive 2-10VDC signal is applied to the +V input and a negative DC signal is applied to the Com/- input.

Table 8 shows the relationship between various external signals to the boiler target temperature. A 4-20mA signal can be converted to a 2-10VDC signal by installing a 500Ω resistor on the external input signal device's terminal.

If the system sensor is ½ (half) of the differential below the Boiler Target, the BTC 1 then changes the proportional modulation output to the START modulation setting, then closes the Stage contact (pins 15 & 16) to proceed to trial for ignition. The burner remains at minimum modulation until the flame is proved and then the modulating output changes the boiler burner out to maintain the programmed boiler target temperature at the system sensor. If the inlet sensor reaches ½ (half) of the differential above Boiler Target, the burner shuts off. Once the external heat demand is removed, the BTC 1 turns off the appliance and operates the boiler pump based on the PUMP DELAY setting.

The auto reset limit is set to 210°F and is fixed. In addition to the auto reset limit, Camus installs a manual reset limit set to 250°F.

**Figure 20: Mode 7 Piping & Electrical Layout**

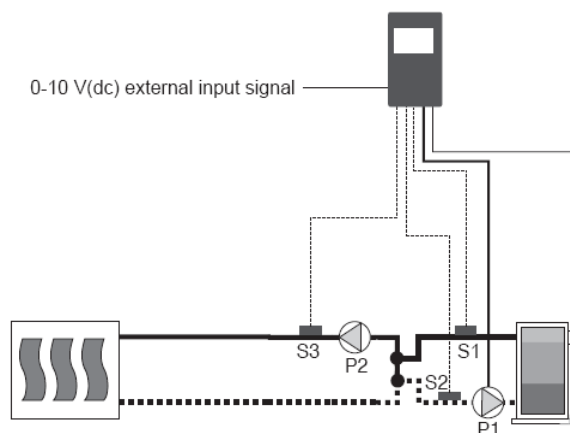

**Mode 8: External Direct Drive Operation**

This mode is designed only for hydronic heating operation. This mode allows for an external control to operate the boiler through an analog direct drive input signal provided by a boiler sequencing control, such as, the S12 Sequencer. When operating in this mode the external heat demand and DHW demand are disabled.

An external boiler sequencer provides a positive 0-10 VDC input signal to the control at +V(in), and the negative signal is applied to the Com/- input.

The boiler remains off while the direct drive input signal range is between 0 to 0.5VDC. Once the direct drive input signal reaches 0.5VDC the control turns on the appliance pump and changes the modulating output to Start Modulation level until the flame is proved and then the modulating output is adjusted to track the direct drive input signal up to the maximum of 10VDC which is equivalent to maximum input rate. When the direct drive signal modulates down to 0.5VDC, the boiler operates at minimum fire. When the signal drops below 0.5VDC the burner is shut off and the pump continues to circulate until the PUMP DELAY timer expires, whereupon the pump shuts off.

The external boiler sequencer can specify the boiler inlet temperature. However, the BOIL MAX setting limits the highest temperature at the outlet sensor. If the outlet temperature exceeds 210°F, the modulating output immediately changes to 0% and the burner is shut off. The burner is to remain off until the minimum off timer is satisfied and the boiler outlet temperature falls by 2°F (1°C) below the BOIL MAX setting.

**Figure 21: Mode 8 Piping & Electrical Layout**

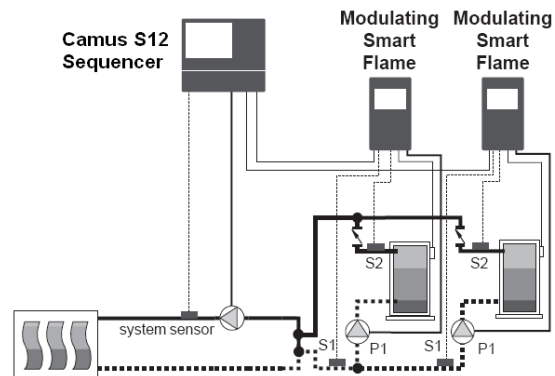



**17.5 TYPICAL FACTORY SETTINGS OF PARAMETERS FOR MICOFLAME GRANDE BTC 1 (78-0017)**

This modulating MicoFlame is equipped with the Camus version of the Tekmar MPA control.

Summary of 8 Modes of Operation

**Mode 1**

- For setpoint control at heater inlet sensor. Use for hydronic constant setpoint heating or domestic hot water applications.
- External heat demand or constant pumping required.

**Mode 2**

- For setpoint control at system sensor
- Ideal for monitoring constant hot loop or for pool heating
- Intermittent pumping provided.

**Mode 3**

- For DHW control with tank sensor. Controls to boiler inlet sensor.
- Intermittent pumping provided

**Mode 4**

- For hydronic heating with outdoor reset. Temperature control at boiler inlet sensor with proportional modulating logic.

**Mode 5**

- For hydronic heating with outdoor reset. Temperature control at system sensor with selectable P.I.D. or proportional modulating logic.
- Intermittent pumping provided

**Mode 6**

- External analogue 0-10VDC signal generates temperature target. Setpoint temperature control at heater inlet sensor using proportional modulating logic.
- Intermittent pumping provided

**Mode 7**

- External analogue 0-10VDC signal generates temperature target. Setpoint temperature control at system sensor with selectable PID or modulating logic.
- Intermittent pumping provided.

**Mode 8**

- External analogue 0-10VDC signal closes the stage contacts to initiate heater. Modulating output of the control follows the analog external input signal. Temperature is controlled remotely independently of local settings. Boiler max. setting remains functional.
- Intermittent pumping provided

**Factory Settings of Modulating Control**

- 1) Access to the setup menu is achieved by pressing the ITEM, UP and DOWN buttons simultaneously for 1 second.

Factory Settings	
Mode	1
Target	175°F (Heating)
	140°F (DHW)
High Limit	230°F (Heating)
	210°F (DHW)
Throttling Range	10°F
Modulation	4:20
Dly Mod.	50 sec
Start Mod.	20%
Min. Mod.	20%
Max. Mod.	Varies with model
Differential	5°F
Pump Delay	1:00 min

## 18 MICROFLAME SERIES 2 CONTROL PANEL

Figure 22: BTC 1 Display Panel

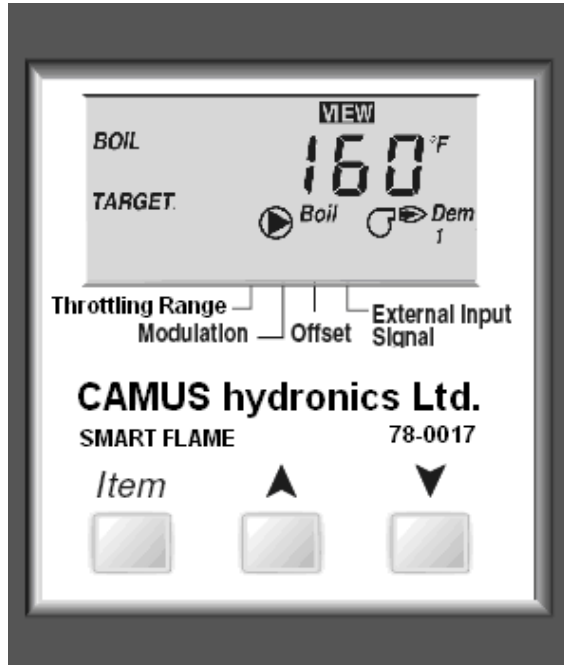

Figure 23: BTC 1 Key Functions



Table 9: BTC 1 Key Functions

KEY	KEY DESCRIPTION
Item	The abbreviated name of the selected item will be displayed in the item field of the display. To view the next item, press the Item button.
▲	Increase a parameter value.
▼	Decrease a parameter value.

### Levels of Access

View – Access to general boiler and display settings and will allow adjustments to the central heating and domestic hot water setpoint.

Adjust – Access to all user parameters and allows for changes to additional boiler parameters to allow for ease of startup and serviceability.







#### 18.1 GENERAL SYMBOL DESCRIPTION

SYMBOL	SYMBOL NAME	SYMBOL DESCRIPTION
<b>Boil</b>	Boiler Pump	Shown when boiler pump is in operation
<b>DHW</b>	DHW Pump	Shown when DHW pump is in operation
<b>Dem 1</b>	Heat Demand	Shown when heat demand is present
<b>Dem 2</b>	Flame Proof	Shown when flame signal is proven
<b>Burner</b>	Burner	Shown when burner is on
<b>Warning</b>	Warning	Shown when an error is present
<b>Pointers</b>	Pointers	Shows the operation as indicated by the text
<b>WWSD</b>	WWSD	Displays when the control is in Warm Weather Shutdown

### 18.2 MODE 1 & 2: SETPOINT OPERATION: VIEW DISPLAY

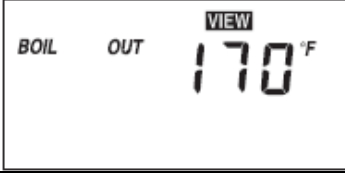
From the Home display;

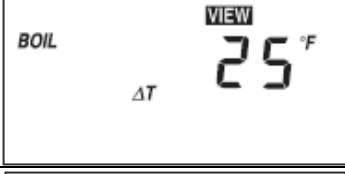
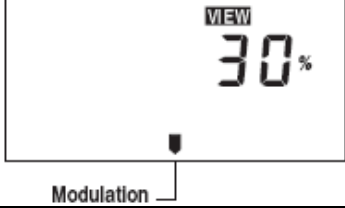



- 1) Press [ITEM] to view the following parameters:

Display	Parameter Name	Parameter Description	Parameter Range
	Boiler Target Temperature	To provide a target setpoint for the heating system. Setpoint is controlled to the inlet sensor	---, 35 to 266°F (---, 2 to 130°C)
	System Temperature	System Temperature of Primary Loop <b>NOTE:</b> This parameter is only available in Mode 2	14 to 266°F (-10 to 130°C)
	Boiler Outlet Temperature	Real-time Outlet Temperature to Boiler	14 to 266°F (-10 to 130°C)
	Boiler Inlet Temperature	Real-time Inlet Temperature to Boiler	14 to 266°F (-10 to 130°C)
	Boiler Delta T	Real-time temperature difference between the outlet sensor and the inlet sensor.	-99 to 252°F (-72 to 140°C)
	Modulation	Real-time modulating output percentage	0 to 100%
	Total Run Time Since Installation	Monitors the amount of operational time since the MicoFlame Series 2 was installed. The first two digits are the number of thousands of hours and the third digit displays the number of hundreds of hours. Press (▲, ▼) simultaneously to reset the counter	0 to 999

### 18.3 MODE 1 & 2: SETPOINT OPERATION: ADJUST DISPLAY

From the Home display;





- 1) Press (Item, ▲, ▼) simultaneously to view the following parameters:

Display	Parameter Name	Parameter Description	Parameter Range
	Mode	Operating mode for the boiler. <b>NOTE:</b> A complete description of each mode can be found in section 8.4 Modes of Operation in this manual.	1 to 8 Default = 1
	Boiler Target Temperature	To provide a target setpoint for the heating system. Setpoint is controlled to the inlet sensor	70 to 220°F (21 to 104°C) Default = 120°F (49°C)
	Differential Temperature	To provide a modulation rate above and below the Boiler Target temperature. For example, if the value is 10°F and the Boiler Target is 160°F the boiler will begin to modulate at 155°F and shut off at 165°F.	Au, 2 to 42°F (Au, -17 to 6°C) Default = Au
	Pump Delay	Boiler post pump time after burner has shut off, in seconds.	OFF, 0:20 to 9:55 min, On Default = 1:00 min
	Temperature Units	Select the desired unit of measurement	°F, °C Default = °F

#### 18.4 MODE 3: DEDICATED DOMESTIC HOT WATER OPERATION: VIEW DISPLAY

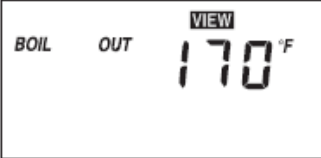
From the Home display;

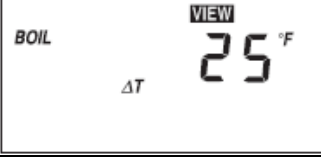
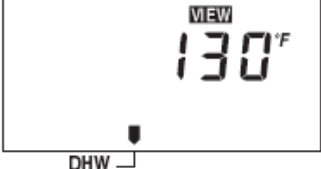
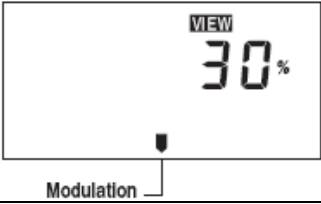





- 1) Press [ITEM] to view the following parameters:

Display	Parameter Name	Parameter Description	Parameter Range
	Boiler Target Temperature	To provide a target setpoint for the heating system. Setpoint is controlled to the inlet sensor	---, 35 to 266°F (---, 2 to 130°C)
	Boiler Outlet Temperature	Real-time Outlet Temperature to Boiler	14 to 266°F (-10 to 130°C)
	Boiler Inlet Temperature	Real-time Inlet Temperature to Boiler	14 to 266°F (-10 to 130°C)
	Boiler Delta T	Real-time temperature difference between the outlet sensor and the inlet sensor.	-99 to 252°F (-72 to 122°C)
	DHW Temperature	Real-time DHW Temperature	14 to 266°F (-10 to 130°C)
	Modulation	Real-time modulating output percentage	0 to 100%
	Total Run Time Since Installation	Monitors the amount of operational time since the MicoFlame Series 2 was installed. The first two digits are the number of thousands of hours and the third digit displays the number of hundreds of hours. Press (▲, ▼) simultaneously to reset the counter	0 to 999

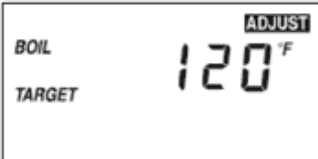
### 18.5 MODE 3: DEDICATED DOMESTIC HOT WATER OPERATION: ADJUST DISPLAY

From the Home display;





- 1) Press (Item, ▲, ▼) simultaneously to view the following parameters:

Display	Parameter Name	Parameter Description	Parameter Range
	Mode	Operating mode for the boiler. <b>NOTE:</b> A complete description of each mode can be found in section 8.4 Modes of Operation in this manual.	1 to 8 Default = 1
	Boiler Target Temperature	To provide a target setpoint for the heating system. Setpoint is controlled to the inlet sensor	OFF, 70 to 220°F (OFF, 21 to 104°C) Default = 120°F (82°C)
	DHW Target Temperature	To provide a target setpoint for the DHW system. Setpoint is controlled to the DHW sensor	OFF, 70 to 190°F (OFF, 21 to 88°C) Default = 140°F (54°C)
	DHW Differential	To provide a modulation rate above and below the DHW Target Temperature. For example, if the value is 10°F and the DHW Target Temperature is 160°F the boiler will begin to modulate at 155°F and shut off at 165°F.	2 to 10°F (1 to 5°C) Default = 3°F (1°C)
	Differential Temperature	To provide a modulation rate above and below the Boiler Target temperature. For example, if the value is 10°F and the Boiler Target is 160°F the boiler will begin to modulate at 155°F and shut off at 165°F.	Au, 2 to 42°F (Au, -17 to 5°C) Default = Au
	Pump Delay	Boiler post pump time after burner has shut off, in seconds.	OFF, 0:20 to 9:55 min, On Default = 1:00 min
	Temperature Units	Select the desired unit of measurement	°F, °C Default = °F

### 18.6 MODE 4 & 5: OUTDOOR RESET OPERATION: VIEW DISPLAY

From the Home display;

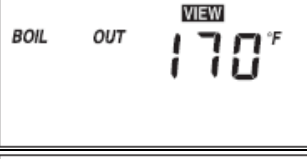
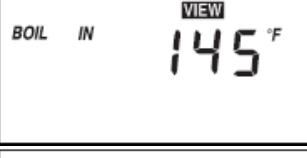
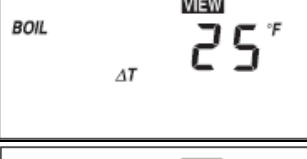
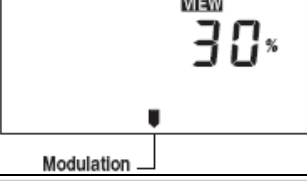





- 1) Press [ITEM] to view the following parameters:

Display	Parameter Name	Parameter Description	Parameter Range
	Outdoor Temperature	Real-time Outdoor Temperature	-60 to 190°F (-51 to 88°C)
	Boiler Target Temperature	To provide a target setpoint for the heating system. Setpoint is controlled to the inlet sensor	---, 35 to 266°F (---, 2 to 130°C)
	System Temperature	System Temperature of Primary Loop <b>NOTE:</b> This parameter is only available in Mode 5	14 to 266°F (-10 to 130°C)
	Boiler Outlet Temperature	Real-time Outlet Temperature	14 to 266°F (-10 to 130°C)
	Boiler Inlet Temperature	Real-time Inlet Temperature	14 to 266°F (-10 to 130°C)
	Boiler Delta T	Real-time temperature difference between the outlet sensor and the inlet sensor.	-99 to 252°F (-72 to 122°C)
	Modulation	Real-time modulating output percentage	0 to 100%
	Total Run Time Since Installation	Monitors the amount of operational time since the MicoFlame Series 2 was installed. The first two digits are the number of thousands of hours and the third digit displays the number of hundreds of hours. Press (▲, ▼) simultaneously to reset the counter	0 to 999

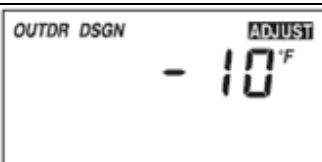
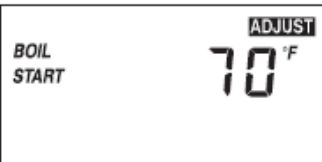

### 18.7 MODE 4 & 5: OUTDOOR RESET OPERATION: ADJUST DISPLAY

From the Home display;

- 1) Press (Item, ▲, ▼) simultaneously to view the following parameters:

Display	Parameter Name	Parameter Description	Parameter Range
	Mode	Operating mode for the boiler. <b>NOTE:</b> A complete description of each mode can be found in section 8.4 Modes of Operation in this manual.	1 to 8 Default = 1
	Outdoor Start Temperature	Outdoor starting temperature used in the reset ratio for the heating system. Typically set to the desired building temperature.	35 to 85°F (2 to 29°C) Default = 60°F (21°C)
	Outdoor Design Temperature	Outdoor design temperature used in the reset ratio for the heating system. Set to the coldest annual outdoor temperature in the local area.	-60 to 50°F (-51 to 10°C) Default = -10°F (-23°C)
	Boiler Start Temperature	Starting water temperature used in the reset ratio calculation for the heating system. Typically set to the desired building temperature.	35 to 150°F (2 to 66°C) Default = 70°F (21°C)
	Boiler Design Temperature	Boiler design water temperature used in the reset ratio calculation for the heating system. Set to the boiler water temperature required to heat the building on the coldest annual outdoor temperature.	70 to 230°F (21 to 110°C) Default = 180°F (82°C)
	Differential Temperature	To provide a modulation rate above and below the Boiler Target temperature. For example, if the value is 10°F and the Boiler Target is 160°F the boiler will begin to modulate at 155°F and shut off at 165°F.	Au, 2 to 42°F (Au, -16 to 5°C) Default = Au
	Pump Delay	Boiler post pump time after burner has shut off, in seconds.	OFF, 0:20 to 9:55 min, On Default = 1:00 min







Display	Parameter Name	Parameter Description	Parameter Range
	Warm Weather Shutdown Temperature	Warm weather shutdown temperature using outdoor reset.	35 to 105°F, OFF (2 to 41°C, OFF) Default = 0:20 min
	Temperature Units	Select the desired unit of measurement	°F, °C Default = °F

### 18.8 MODE 6 & 7: EXTERNAL TARGET TEMPERATURE INPUT OPERATION: VIEW DISPLAY

From the Home display;

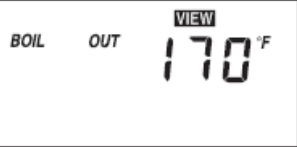
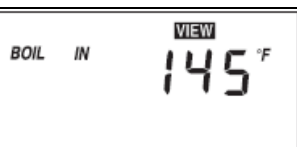
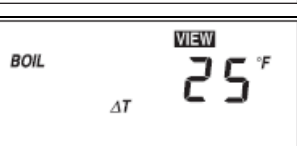
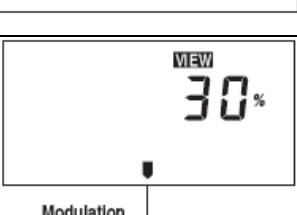
- 1) Press [ITEM] to view the following parameters:





Display	Parameter Name	Parameter Description	Parameter Range
	Boiler Target Temperature	To provide a target setpoint for the heating system. Setpoint is controlled to the inlet sensor.	---, 35 to 266°F (---, 2 to 130°C)
	System Temperature	Real-time System Temperature <b>NOTE:</b> This parameter is only available in Mode 7	14 to 266°F (-10 to 130°C)
	Boiler Outlet Temperature	Real-time Outlet Temperature to Boiler	14 to 266°F (-10 to 130°C)
	Boiler Inlet Temperature	Real-time Inlet Temperature to Boiler	14 to 266°F (-10 to 130°C)
	Boiler Delta T	Real-time temperature difference between the outlet sensor and the inlet sensor.	-99 to 252°F (-72 to 122°C)
	Modulation	Real-time modulating output percentage	0 to 100%

Display	Parameter Name	Parameter Description	Parameter Range
	Total Run Time Since Installation	Monitors the amount of operational time since the MicoFlame Series 2 was installed. The first two digits are the number of thousands of hours and the third digit displays the number of hundreds of hours. Press (▲, ▼) simultaneously to reset the counter	0 to 999

### 18.9 MODE 6 & 7: EXTERNAL TARGET TEMPERATURE INPUT OPERATION: ADJUST DISPLAY

From the Home display;

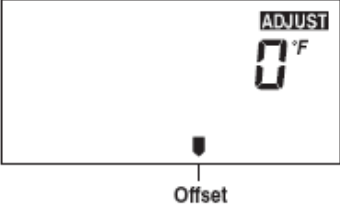



- 1) Press (Item, ▲, ▼) simultaneously to view the following parameters:

Display	Parameter Name	Parameter Description	Parameter Range
	Mode	Operating mode for the boiler. <b>NOTE:</b> A complete description of each mode can be found in section 8.4 Modes of Operation in this manual.	1 to 8 Default = 1
	Differential Temperature	To provide a modulation rate above and below the Boiler Target temperature. For example, if the value is 10°F and the Boiler Target is 160°F the boiler will begin to modulate at 155°F and shut off at 165°F.	Au, 2 to 42°F (Au, -17 to 6°C) Default = Au
	Pump Delay	Boiler post pump time after burner has shut off, in seconds.	OFF, 0:20 to 9:55 min, On Default = 1:00 min
	Offset	To provide a modulation rate above and below the Boiler Target temperature. For example, if the value is 10°F and the Boiler Target is 160°F the boiler will begin to modulate at 155°F and shut off at 165°F.	-10 to 10°F (-23 to 12°C) Default = 0°F
	Temperature Units	Select the desired unit of measurement	°F, °C Default = °F

**18.10 MODE 8: EXTERNAL DRIVE OPERATION: VIEW DISPLAY**

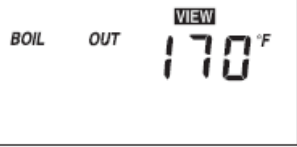
From the Home display;

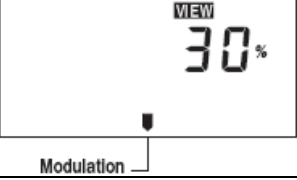
2) Press [ITEM] to view the following parameters:

Display	Parameter Name	Parameter Description	Parameter Range
	Boiler Outlet Temperature	Real-time Outlet Temperature to Boiler	14 to 266°F (-10 to 130°C)
	Boiler Inlet Temperature	Real-time Inlet Temperature to Boiler	14 to 266°F (-10 to 130°C)
	Boiler Delta T	Real-time temperature difference between the outlet sensor and the inlet sensor.	-99 to 252°F (-72 to 122°C)
	Modulation	Real-time modulating output percentage	0 to 100%
	Total Run Time Since Installation	Monitors the amount of operational time since the MicoFlame Series 2 was installed. The first two digits are the number of thousands of hours and the third digit displays the number of hundreds of hours. Press (▲, ▼) simultaneously to reset the counter	0 to 999



**Table 10: Input Voltage vs. Modulation Rate**

Input Voltage	Modulation	Input Voltage	Modulation
[V]	[%]	[V]	[%]
0	0	4	36.8
0.5	0	5	47.4
1	5.3	6	57.9
1.5	10.5	7	68.4
2	15.8	8	78.9
2.5	21.1	9	89.5
3	26.3	10	100

### 18.11 MODE 8: EXTERNAL DRIVE OPERATION: ADJUST DISPLAY





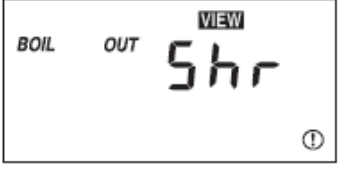
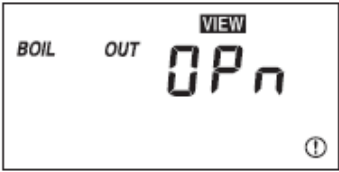

From the Home display;

- 1) Press (Item, ▲, ▼) simultaneously to view the following parameters:

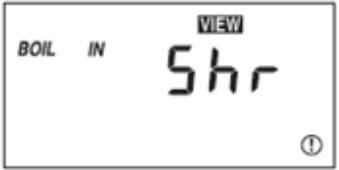
Display	Parameter Name	Parameter Description	Parameter Range
	Mode	Operating mode for the boiler. <b>NOTE:</b> A complete description of each mode can be found in section 8.4 Modes of Operation in this manual.	1 to 8 Default = 1
	Pump Delay	Boiler post pump time after burner has shut off, in seconds.	OFF, 0:20 to 9:55 min, On Default = 1:00 min
	Temperature Units	Select the desired unit of measurement	°F, °C Default = °F

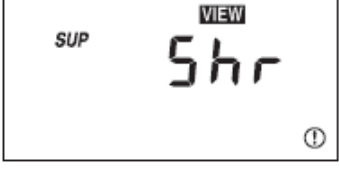
### 18.12 ERROR MESSAGES

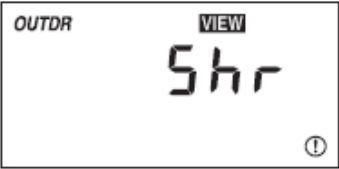
Error Message	Description
	The control was unable to read a piece of information its EEPROM memory. The control will stop operation until all settings in the Adjust menu have been checked by the installer.
	<b>Outlet Sensor Short Circuit.</b> If the inlet sensor is operational, the control will operate using the inlet sensor. Otherwise, the control will not operate the burner.  Test the outlet sensor and related wiring. The error message will clear once the error condition is corrected and a button is pressed.
	<b>Outlet Sensor Open.</b> If the inlet sensor is operational, the control will operate using the inlet sensor. Otherwise, the control will not operate the burner.  Test the outlet sensor and related wiring. The error message will clear once the error condition is corrected and a button is pressed.

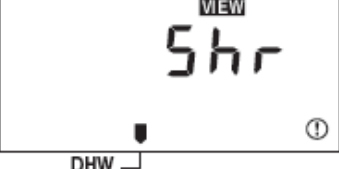
Error Message	Description
	<p><b>Inlet Sensor Short Circuit</b> The boiler will continue operation.</p> <p>Test the inlet sensor and related wiring. The error message will clear once the error condition is corrected and a button is pressed.</p>
	<p><b>Inlet Sensor Open</b> The boiler will continue operation</p> <p>Test the inlet sensor and related wiring. The error message will clear once the error condition is corrected and a button is pressed.</p>
	<p><b>System Sensor Short Circuit</b> If the outlet sensor is operational, the boiler will operate using the outlet sensor. If the outlet sensor is not available and the inlet sensor is operational, the boiler will operate using the inlet sensor. Otherwise, the control will not operate the burner.</p> <p>Test the supply sensor and related wiring. The error message will clear once the error condition is corrected and a button is pressed.</p>
	<p><b>System Sensor Open</b> If the outlet sensor is operational, the boiler will operate using the outlet sensor. If the outlet sensor is not available and the inlet sensor is operational, the boiler will operate using the inlet sensor. Otherwise, the control will not operate the burner.</p> <p>Test the supply sensor and related wiring. The error message will clear once the error condition is corrected and a button is pressed.</p>
	<p><b>Outdoor Sensor Short Circuit</b> The BTC 1 assumes an outdoor temperature of 32°F (0°C) and continues operation.</p> <p>Test the outdoor sensor and related wiring. The error message will clear once the error condition is corrected and a button is pressed.</p>
	<p><b>Outdoor Sensor Open</b> The BTC 1 assumes an outdoor temperature of 32°F (0°C) and continues operation.</p> <p>Test the outdoor sensor and related wiring. The error message will clear once the error condition is corrected and a button is pressed.</p>
	<p><b>DHW Sensor Short Circuit</b> The control will not operate the burner.</p> <p>Test the DHW sensor and related wiring. The error message will clear once the error condition is corrected and a button is pressed.</p>

	<p><b>DHW Sensor Open</b> The control will not operate the burner.</p> <p>Test the DHW sensor and related wiring. The error message will clear once the error condition is corrected and a button is pressed.</p>
	<p><b>Flame Proof Error</b> Flame was not proved within 120 seconds of Demand 1</p>

## 19 PILOT AND MAIN BURNER FLAMES

To maintain safe operation and the greatest efficiency of the boiler, check the main burner and pilot burner every six months for proper flame characteristics.

### 19.1 MAIN BURNER

The main burner, Figure 24 should display the following characteristics;

- Acceptable CO and CO<sub>2</sub> levels for complete combustion.
- Light off smoothly.
- Reasonably quiet while running.
- Stable flame with minimum of lifting.
- Blue flame with natural gas, yellow tips with propane gas

**Figure 24: Burner**

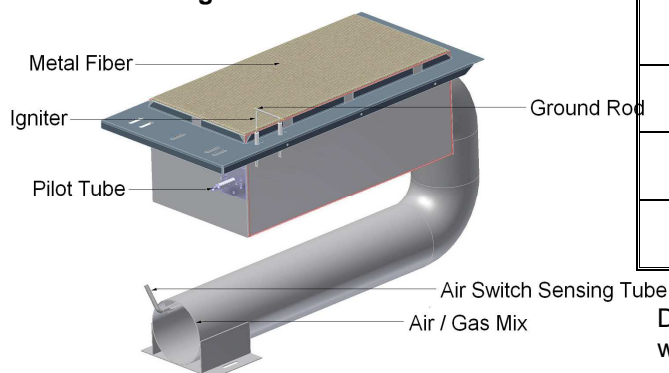

If burner characteristics do not match the above, check for proper air box pressure. Also look for accumulation of lint and other foreign material at fan air inlets. Typical air box settings are as follows (settings in brackets denotes condensing application):

**Table 11: Air Box Settings**

MODEL	AIR BOX " W.C. (with burner firing)		FLUE SWITCH RECYCLE POINT " W.C	
	Left Burner	Right Burner	Left Burner	Right Burner
800	-	1.4 (1.7)	-	1.0 (1.4)
1000	-	1.9 (2.2)	-	1.5 (1.9)
1200	0.9 (1.1)	0.9 (1.1)	0.8 (0.9)	0.7 (0.9)
1400	0.9 (1.1)	1.4 (1.7)	0.7 (0.9)	1.1 (1.3)
1600	0.9 (1.1)	1.9 (2.2)	0.7 (0.9)	1.5 (1.8)
1800	1.6 (1.9)	1.6 (1.9)	1.2 (1.6)	1.2 (1.6)
2000	1.9 (2.2)	1.9 (2.2)	1.5 (1.9)	1.5 (1.9)

Depending on field conditions air box pressures will have to be adjusted accordingly.

Always set the appliance for a CO<sub>2</sub> level in the range listed in Table 12.

**Table 12: Combustion Values**

		Natural Gas		Propane	
		CO <sub>2</sub>	CO	CO <sub>2</sub>	CO
<b>Non-Condensing</b>	<b>Max. Fire</b>	7.5% - 8.5%	< 50 PPM	9.0% - 10.0%	< 50 PPM
	<b>Min. Fire</b>	7.0% - 7.5%	< 50 PPM	8.5% - 9.0%	< 50 PPM
<b>Condensing</b>	<b>Max. Fire</b>	8.5% - 9.0%	< 50 PPM	10.0% - 10.5%	< 50 PPM
	<b>Min. Fire</b>	7.5% - 8.0%	< 50 PPM	9.0% - 9.5%	< 50 PPM

A qualified service technician should follow this procedure when burner needs cleaning.

1. Shut off power and close main manual gas valve.
  - Allow burner to cool before removal.
2. Remove access cover screws.
  - Disconnect pilot gas at bulkhead fitting.
  - Disconnect ground wire and ignition wire.
  - Remove two wing nuts holding down burner.
  - Gently pull down and forward to disengage burner.
  - Remove burner being careful to not damage the igniter or ground electrodes.
3. Thoroughly clean burner. Check all ports and air channels for blockage.
4. Reinstall the burner being careful to fully engage the back of the burner box into the retaining slot in the combustion chamber base. Failure to properly locate the burner will result in erratic flame operation with the possibility of delayed ignition on light off.
5. Restore electrical power and gas supply to the boiler.
  - Following the lighting instructions put the boiler back into operation
  - Check for gas leaks and proper boiler and vent operation.

## 19.2 REMOVAL OF COMBUSTION CHAMBER LINING

The combustion chamber insulation in this appliance contains ceramic fiber material. Ceramic fibers can be converted to cristobalite in very high temperature applications. The International Agency for Research on Cancer (IARC) has concluded, "Crystalline silica in this form of quartz of cristobalite from occupational sources is carcinogenic to humans (Group 1)". Normal operating temperatures in this appliance are below the level to convert ceramic fibers to cristobalite. Abnormal operating conditions would have to be created to convert the ceramic fibers in this appliance to cristobalite.

The ceramic fiber material used in this appliance is an irritant; when handling or replacing the ceramic materials it is advisable that the installer follow these safety guidelines.

- Avoid breathing dust and contact with skin and eyes.
    - Use NIOSH certified dust respirator (N95). This type of respirator is based on the OSHA requirements for cristobalite at the time this documentation was written. Other types of respirators may be needed depending on the job site conditions. Current NIOSH recommendations can be found on the NIOSH website at <http://www.cdc.gov/niosh/homepage.html>. NIOSH approved respirators, manufacturers, and phone numbers are also listed on this website.
    - Wear long-sleeved, loose fitting clothing, gloves, and eye protection
  - Apply enough water to the combustion chamber lining to prevent airborne dust.
  - Remove the combustion chamber lining from the water heater and place it in a plastic bag for disposal.
  - Wash potentially contaminated clothes separately from other clothing. Rinse clothes washer thoroughly.
- NIOSH stated First Aid**
- Eye: Irrigate immediately
  - Breathing: Fresh air

### 19.3 PILOT BURNER

Turn the pilot firing valve to off position and allow the boiler to try for ignition. Observe the spark making sure that it is strong and continuous.

If the spark is not acceptable the igniter will have to be adjusted. This can be readily accomplished after removing the main burner.

The spark gap should be 1/8" to 3/16" between igniter and ground rod and 3/8" between igniter and surface of metal fiber. Make sure that the electrode does not appear overheated or fouled with carbon. It may be necessary to clean the ignition electrode using steel wool. Once the pilot appears to be properly set, reinstall it into the appliance making sure to properly tighten the pilot line connection.

If the pilot is removed from the main burner in the course of servicing the appliance, it is important to reinstall it so that there is no gap between the top surface of the pilot tube and the underside of the metal filter support screen. When properly set it will not be possible to slip a business card between the pilot burner and the support screen. Figure 25 shows the burner box assembly with the metal filter cover removed to expose pilot tube.

**Figure 25: Pilot and Burner Box**

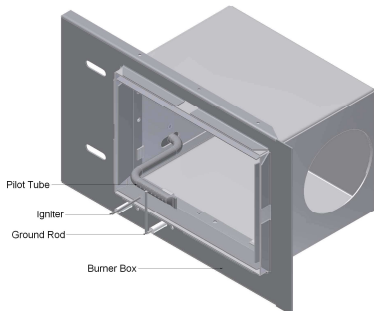

Once the spark is satisfactory, open the pilot gas and allow the pilot burner to light. Once air has been purged from the pilot line, the pilot flame should appear almost instantly at the initiation of spark. Cycle the pilot several times to confirm reliability. A properly set pilot will appear blue and will engulf the igniter and ground electrode.

Open the firing valve and allow the main burner to light. The pilot must not extinguish. After running for 15 minutes, cycle the boiler to ensure that the pilot remains stable.

## 20 OPERATION AND SERVICE

### 20.1 PRE-START CHECKLIST

Before operating the boiler, the entire system must be filled with water, purged of air and checked for leaks. Do not use Stop leak or other boiler compounds. The gas piping must also be leak tested.

Any safety devices including low water cutoff, flow switch and high limit used in with this boiler must receive periodic inspection (every six months) to assure proper operation. A low water cutoff of the float type should be flushed every six months. All relief valves should be inspected and manually operated every six months.

For your safety follow the lighting and operating instructions below and on the boiler.

To turn on main burner, slowly open firing valve after pilot is established.

Set primary system controller to desired temperature.

To turn off boiler close main manual gas valve, close pilot manual valve and turn off electric power to system.

### 20.2 START-UP

Gas appliances are rated based on sea level operation with no adjustment required at elevations up to 2000 ft. At elevations above 2000 ft the input rating must be reduced by 4% for each additional 1000 ft elevation. Never increase the input of the appliance above that for which it is rated.

#### Pilot Pressure Setting

The pilot was preset at the factory. The following description is for the benefit of the start-up technician should minor adjustment be required. The pilot burner is controlled by a separate pilot valve. Pilot pressure setting is as shown in Table 13. A view port is provided on the appliance's return end to view the pilot and the main burners. If adjustment is necessary the following steps must be followed: Remove the lower front jacket panel; Remove the 1/8" plug from the elbow pressure tap and connect a manometer; Remove regulator adjustment screw cap from the pilot valve; Rotate the regulator adjustment screw clockwise to increase the manifold pressure or counterclockwise to decrease it;



Once satisfied replace the regulator adjustment screw cap and the elbow pressure tap plug.

**Table 13: Gas pressures at inlet to pilot**

	PROPANE	NATURAL GAS
Minimum (inches W.C.)	3.9	1.3
Maximum (inches W.C.)	9.3	3.5

### Pilot Flame Rectification Setting

The pilot flame rectification was preset at the factory. The following description is for the benefit of the start-up technician should minor adjustment be required. Set pilot to obtain best  $\mu A$  reading from flame rectification. Minimum average signal of 1.5  $\mu A$  is required. If required, test the signal using a DC  $\mu A$  meter following this procedure for Honeywell S8600 ignition module: Disconnect ground wire at appliance transformer; Disconnect the 24V power and ground wires from all S8600 ignition modules not being tested; Set meter to  $\mu A$  DC: Connect one of the meter's terminals to the burner ground terminal on the S8600 and the other terminal to the burner ground wire; Pilot running without main burner will generate 1.5  $\mu A$  average for best operation. With main burner running, the signal will be in a range of 4.0 to 7.0  $\mu A$ .

### Gas Pressure Setting

The gas valve pressure regulator was preset at the factory. The following description is for the benefit of the start-up technician should minor adjustment be required.

Optimum results are obtained when the appliance is operated with manifold pressure as indicated on the rating plate. If adjustment is necessary the following steps must be followed (please refer to Figure 26): Remove the lower front jacket panel; Remove the 1/8" plug from the elbow pressure tap and connect a manometer; Remove regulator adjustment screw cap from the combination valve; Rotate the regulator adjustment screw clockwise to increase the manifold pressure or counterclockwise to decrease it; Once satisfied replace the regulator adjustment screw cap and the elbow pressure tap plug.

### Air Flow Setting

The fan inlet air shutter has been preset at the factory. The following description is for the benefit of the start-up technician should minor adjustment be required.

Optimum results are obtained when the appliance is operated with air box pressure as shown on rating plate. If adjustment is necessary the following steps must be followed: Remove the lower front jacket panel; connect a manometer to the air pressure tap provided on the combustion chamber door; with the fan operating the air pressure should be set per the rating plate by adjusting the air inlet shutter on the fan inlet; To adjust the air shutter, first undo the securing nut and rotate the bolt so the shutter will open or close as required. Once satisfied tighten the nut on the fan's shutter bolt making sure it is secured.

### MF 800 – 1000

**Figure 26: MF 800 – 1000 Gas Valve**

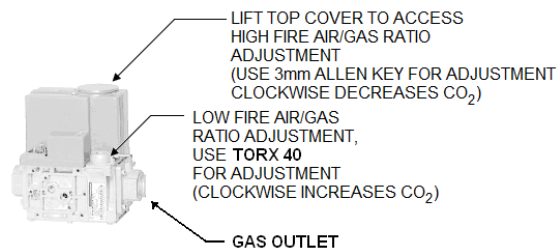

### To adjust the high fire setting

Set the Target Temperature to 190°F using the BTC 1 Controller.

Once the appliance is at maximum fan speed locate the input adjustment screw on the top side of the gas valve. Using a flat head screwdriver turn the screw clockwise to decrease CO<sub>2</sub> levels and counter-clockwise to increase CO<sub>2</sub> levels. Turn the screw 1/4 turn in either way for each adjustment to keep track of the adjustments. After adjusting the screw wait a moment for the combustion levels to stabilize before attempting to make any further adjustments. Continue this procedure until combustion levels are satisfied.

Reset the Target Temperature to normal operating conditions on the BTC 1 Controller.

To adjust the low fire setting

Observe the Boiler Inlet Temperature. Set the Boiler Target temperature so that it is 10°F above the Boiler Inlet Temperature. The boiler will begin to modulate to low-fire as setpoint is being reached. The actual modulation rate can be shown on the screen as Modulation, this will be shown as a percentage. Low-fire is achieved at 25%.

The MicoFlame will respond immediately and operate at low fire. When this is achieved locate the low fire adjustment screw as illustrated in Figure 26. Using a flat screwdriver rotate clockwise to increase CO<sub>2</sub> levels and counter-clockwise to decrease CO<sub>2</sub> levels. When the correct combustion values are achieved replace the screw cap back on to the gas valve.

Reset the Target Temperature to normal operating conditions on the BTC 1 Controller.

Always set the appliance for a CO<sub>2</sub> level in the range listed in Table 14.

**MF 1200 – 2000**

**Figure 27: MF 1200 – 2000 Gas Valve**

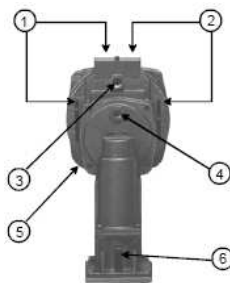

To adjust the high fire setting

Set the Target Temperature to 190°F using the BTC 1 Controller.

Locate screw (1) labeled as <<P<sub>GAS</sub>/P<sub>AIR</sub>>> and make adjustments as necessary to satisfy the combustion values in Table 14. The markings on the setting screws are labeled as “+” and “-”, for more and less gas, respectively. Turn the screw 1/4 turn in either way for each adjustment to keep track of the adjustments. After adjusting the screw wait a moment for the combustion levels to stabilize before attempting to make any further adjustments. Continue this procedure until combustion levels are satisfied.

Reset the Target Temperature to normal operating conditions on the BTC 1 Controller.

To adjust the low fire setting

Observe the Boiler Inlet Temperature. Set the Boiler Target temperature so that it is 10°F above the Boiler Inlet Temperature. The boiler will begin to modulate to low-fire as setpoint is being reached. The actual modulation rate can be shown on the screen as Modulation, this will be shown as a percentage.

Locate screw (2) labeled as  and make adjustments as necessary to satisfy the combustion values in Table 14. The markings on the setting screws are labeled as “+” and “-”, for more and less gas, respectively. Turn the screw 1/4 turn in either way for each adjustment to keep track of the adjustments. After adjusting the screw wait a moment for the combustion levels to stabilize before attempting to make any further adjustments. Continue this procedure until combustion levels are satisfied.

Reset the Target Temperature to normal operating conditions on the BTC 1 Controller.

**Table 14: Combustion Values**

		Natural Gas		Propane	
		CO <sub>2</sub>	CO	CO <sub>2</sub>	CO
<b>Non-Condensing</b>	<b>Max. Fire</b>	7.5% - 8.5%	< 50 PPM	9.0% - 10.0%	< 50 PPM
	<b>Min. Fire</b>	7.0% - 7.5%	< 50 PPM	8.5% - 9.0%	< 50 PPM
<b>Condensing</b>	<b>Max. Fire</b>	8.5% - 9.0%	< 50 PPM	10.0% - 10.5%	< 50 PPM
	<b>Min. Fire</b>	7.5% - 8.0%	< 50 PPM	9.0% - 9.5%	< 50 PPM

**Pressure Switch Settings**

The switches have been preset at the factory as per Table 14. The following description is for the benefit of the start-up technician should minor adjustment be required.

Differential air pressure switches are provided to shut down the gas supply line under block flue condition. One pressure switch is provided per burner. If adjustment is necessary the following steps must be followed: Remove the lower front jacket panel; insert allen key into the switch located on the combustion chamber door; with the fan operating the switch should be set per Table 14 by rotating the allen key.

**Table 15: Air Box Settings**

MODEL	AIR BOX “ W.C. (with burner firing)		FLUE SWITCH RECYCLE POINT “ W.C	
	Left Burner	Right Burner	Left Burner	Right Burner
800	-	1.4 (1.7)	-	1.0 (1.4)
1000	-	1.9 (2.2)	-	1.5 (1.9)
1200	0.9 (1.1)	0.9 (1.1)	0.8 (0.9)	0.7 (0.9)
1400	0.9 (1.1)	1.4 (1.7)	0.7 (0.9)	1.1 (1.3)
1600	0.9 (1.1)	1.9 (2.2)	0.7 (0.9)	1.5 (1.8)
1800	1.6 (1.9)	1.6 (1.9)	1.2 (1.6)	1.2 (1.6)
2000	1.9 (2.2)	1.9 (2.2)	1.5 (1.9)	1.5 (1.9)

**Blocked Flue Switch**

The normally-closed blocked flue switch has been preset at the factory according to Table 15. In cases where the heater loses the flame signal as it approaches high-fire adjustment to the blocked flue switch may be necessary. The following description is for the benefit of the start-up technician should minor adjustment be required.

- a. Remove the lower front jacket panel
- b. Reduce sensitivity of blocked flue switch by turning the flat screw ¼ turn clockwise with the fan inlet 1/3 blocked.
- c. Observe the operation of the burner as it approaches high fire, if the heater continues to operate at high fire the switch has been correctly set. If not, repeat steps 2 and 3.
- d. Re-install lower front jacket panel

**Ignition System Safety Shut-Off Device**

After initial fill while the main burner is firing, shut off gas to the pilot and clock the time taken for the main gas valve to shut down. If the safety control is functioning properly, power to the gas valve will be shut off within 4 seconds of the pilot gas being shut off. If shut down takes longer, ignition control or gas valve may be defective. If shutdown does not occur it is possible that the main flow is generating a signal at the pilot in which case the pilot shall not recycle with the pilot gas off.

**Appliances Start Up**

With the appliance off, open makeup water valve and allow system to fill slowly. With all air vents open, run system circulating pump for a minimum of 30 minutes with the appliance off. Open all strainers in the circulating system and check for debris. Check liquid level in expansion tank. With system full of water at 15 PSIG cold, the level of water in the expansion tank should not exceed ¼ of the total volume with the balance filled with air. Start up appliance following instructions provided. Operate entire system including pumps and radiation for at least 1 hour. Check water level in expansion tank. If level exceeds ½ of tank volume, air is still trapped in system. Shut down appliance and continue to run pumps. Within 3 days of start up, recheck all air vents and expansion tank as described above.

### **20.3 SERVICE**

Disconnect main power and turn off gas supply before servicing unit.

To remove and clean the burner, follow the detailed procedure in section 17.1 of this manual

After the first season of operation inspect the heat exchanger and venting. Follow the detailed instructions in section 6 of this manual.

**CAUTION:** Label all wires prior to disconnection when servicing controls. Wiring errors can cause improper and dangerous operation. Verify proper operation after servicing.

Any audible sounds in the equipment, like pinging, crackling or hissing are indications of scaling or lack of sufficient water flow. Under these conditions the boiler must be shut down immediately and the heat exchanger checked for damage. If the exchanger is damaged from scaling, it is not covered by warranty.

Should your equipment be subjected to fire, flood or some other unusual condition, turn off all gas and electrical supply. If you are unable to turn off the gas call your gas company or gas supplier at once. Do not put the unit back in operation until it has been checked by a qualified agency to ensure that all controls are functioning properly.

Units that are not operated for a period of 60 days or more are considered seasonal operations. It is recommended that before returning one of these units to service, the proper operation of all controls be checked by a qualified service technician.

### **21 LIGHTING INSTRUCTIONS**

- 1) Turn off electric power to boiler.
- 2) Close main manual valve and main firing valve and wait 5 minutes.
- 3) Set primary system controller to desired temperature.
- 4) Open pilot valve.
- 5) Turn on electric power to boiler. The electrode at the pilot should begin to spark after pre-purge is complete. The pilot valve will open to permit gas flow to the pilot.
- 6) There is a 15 second trial for ignition, which is enough time to light the pilot if air is not present in the pilot line. If pilot fails to light and you suspect air in the line, close the main manual valve and repeat lighting steps 1 thru 5.
- 7) Once the pilot lights, it should envelope the ignition rod and ground electrode. The pilot can be adjusted by removing the pilot regulator cover and turning the adjustment screw counter clockwise to decrease it or clockwise to increase it.
- 8) Open the main manual and main firing valves to allow gas to reach the main burner. If the main burner fails to ignite, turn the firing valve off and check to see that the pilot is burning. If not, repeat lighting procedure steps 1 thru 7.
- 9) **TO TURN OFF BOILER:** Close main manual valve and main firing valve and turn off electric power to system.

## 22 TROUBLE SHOOTING GUIDE

SYMPTOM	SOLUTION
1. Power light is not lit when switch is flipped to "ON"	<ul style="list-style-type: none"> <li>• Check wiring to switch.</li> <li>• Check circuit breaker.</li> <li>• Check fuse.</li> </ul>
2. Water flow light remains off.	<ul style="list-style-type: none"> <li>• Verify that pump is running.</li> <li>• Check wiring to flow switch.</li> </ul>
3. Pilot sparks but does not light	<ul style="list-style-type: none"> <li>• Verify that main manual valve is open.</li> <li>• Follow lighting instructions to bleed air out of pilot line.</li> <li>• Remove main burner and inspect for moisture or dirt in pilot or in pilot line.</li> <li>• Verify that pilot is sealed to main burner base.</li> <li>• Verify that gas connections are tight.</li> </ul>
4. Pilot lights momentarily, goes out and then sparks again repeatedly	<ul style="list-style-type: none"> <li>• Observe pilot for proper flame. Adjust if necessary.</li> <li>• Check pilot flame signal. Properly set pilot to generate 1.5 <math>\mu</math>A. D.C. on average.</li> <li>• Remove main burner and ensure that igniter and ground electrodes are positioned properly. Clean with steel wool if necessary.</li> <li>• Verify that back of burner box is fully engaged into the retaining slot in the combustion chamber base.</li> </ul>
5. Pilot lights but main burner does not fire.	<ul style="list-style-type: none"> <li>• Verify that high limit is set high enough to prevent short cycling.</li> <li>• Check pilot flame signal (<math>\mu</math>A).</li> <li>• Adjust pilot pressure for steady flame</li> <li>• Remove main burner. Check position of igniter and ground electrode. Clean with steel wool if necessary.</li> </ul>
6. Main burner lights but cycles off after a few minutes	<ul style="list-style-type: none"> <li>• Verify that high limit is set high enough to prevent short cycling.</li> <li>• Adjust pilot pressure for steady flame</li> <li>• Remove main burner. Adjust pilot shield and clean ignition sensor.</li> </ul>
7. Boiler starts to whine as the temperature rise increases.	<ul style="list-style-type: none"> <li>• Verify that all air is bled from system.</li> <li>• Verify that the static pressure in cold system is at least 15 psig.</li> <li>• Check temperature rise across boiler to ensure adequate water flow.</li> <li>• If necessary, increase static water pressure and decrease gas pressure.</li> </ul>

## 23 TYPICAL GAS TRAIN

Figure 28: MicoFlame Modulation 800 – 1000 Gas Train

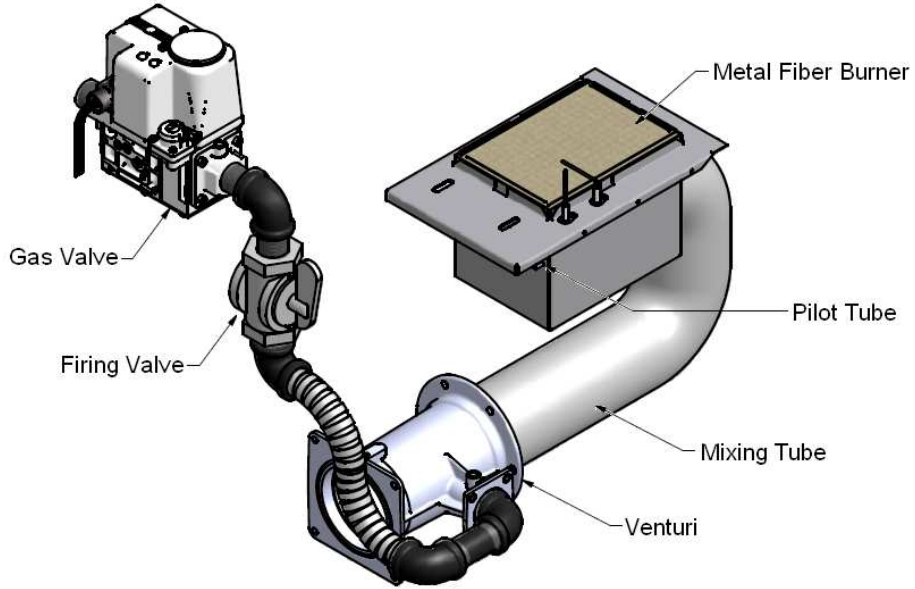
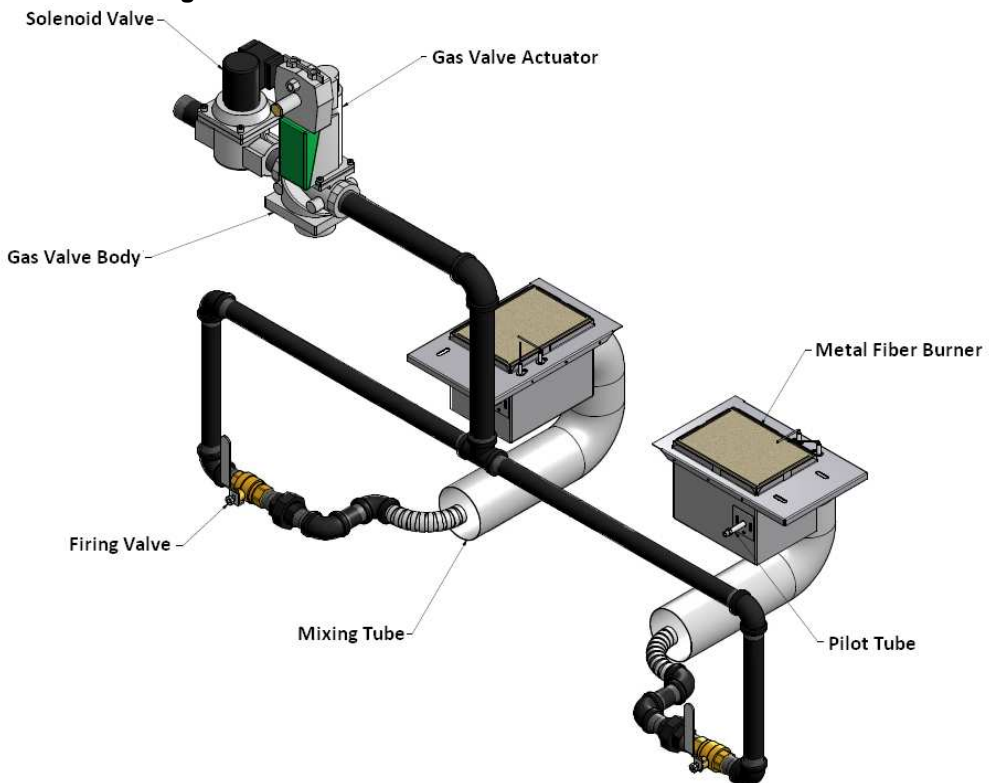
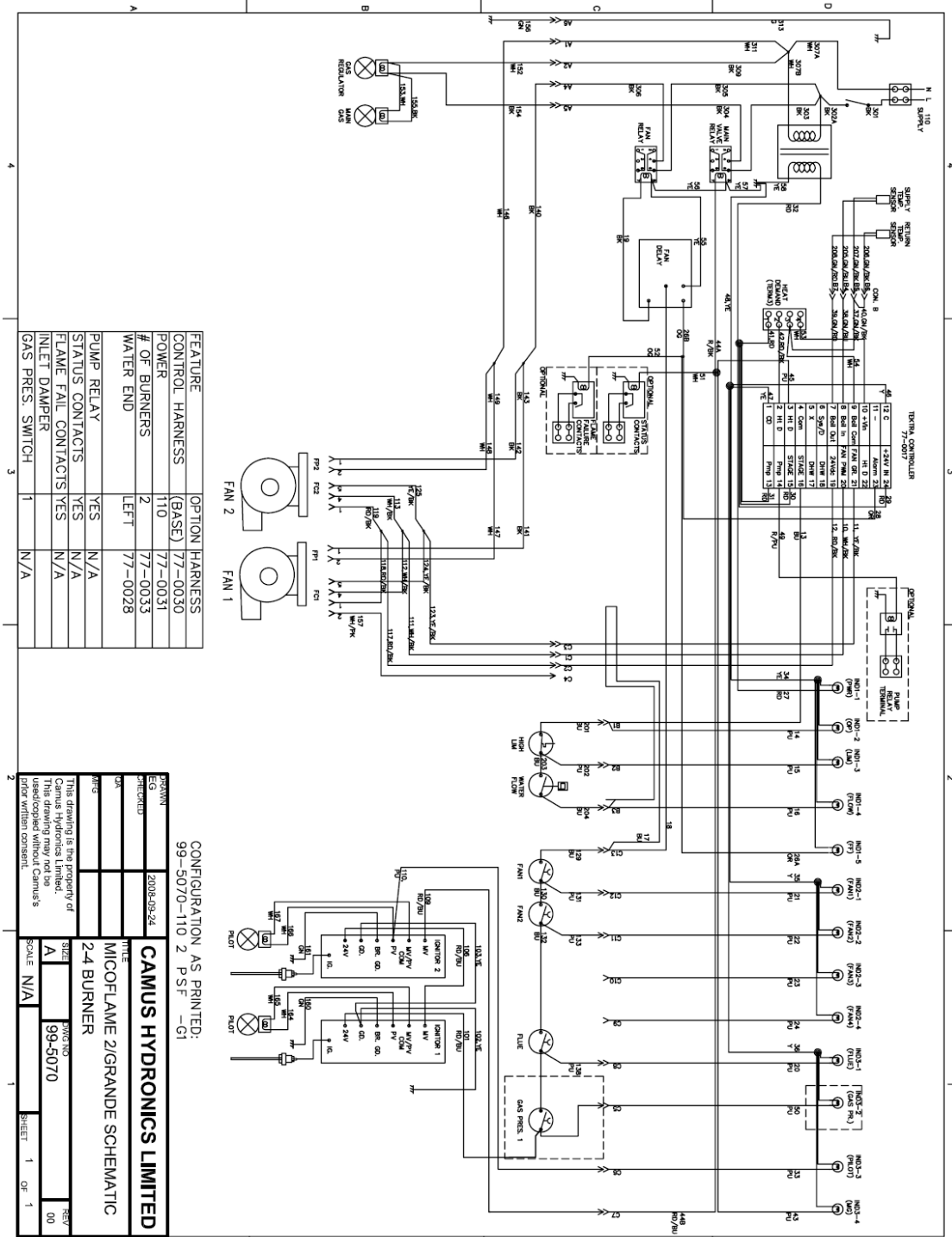

Figure 29: MicoFlame Modulation 1200 – 2000 Gas Train



# 24 ELECTRICAL DIAGRAMS

## 24.1 MF 800 - 2000 INTERNAL WIRING CONNECTION DIAGRAM



CONFIGURATION AS PRINTED:  
99-5070-110 2 P.S.F. -G1

REV	DATE	BY	CHKD	DESCRIPTION
00	99-5070			THIS DRAWING IS THE PROPERTY OF CAMBUS HYDRONICS LIMITED. THIS DRAWING MAY NOT BE REPRODUCED OR COPIED IN ANY MANNER WITHOUT CAMBUS'S PRIOR WRITTEN CONSENT.

REV	DATE	BY	CHKD	DESCRIPTION
00	99-5070			THIS DRAWING IS THE PROPERTY OF CAMBUS HYDRONICS LIMITED. THIS DRAWING MAY NOT BE REPRODUCED OR COPIED IN ANY MANNER WITHOUT CAMBUS'S PRIOR WRITTEN CONSENT.

  

SCALE	N/A
SHEET	1 OF 1

REV	DATE	BY	CHKD	DESCRIPTION
00	99-5070			THIS DRAWING IS THE PROPERTY OF CAMBUS HYDRONICS LIMITED. THIS DRAWING MAY NOT BE REPRODUCED OR COPIED IN ANY MANNER WITHOUT CAMBUS'S PRIOR WRITTEN CONSENT.

**25 EXPLODED VIEW**



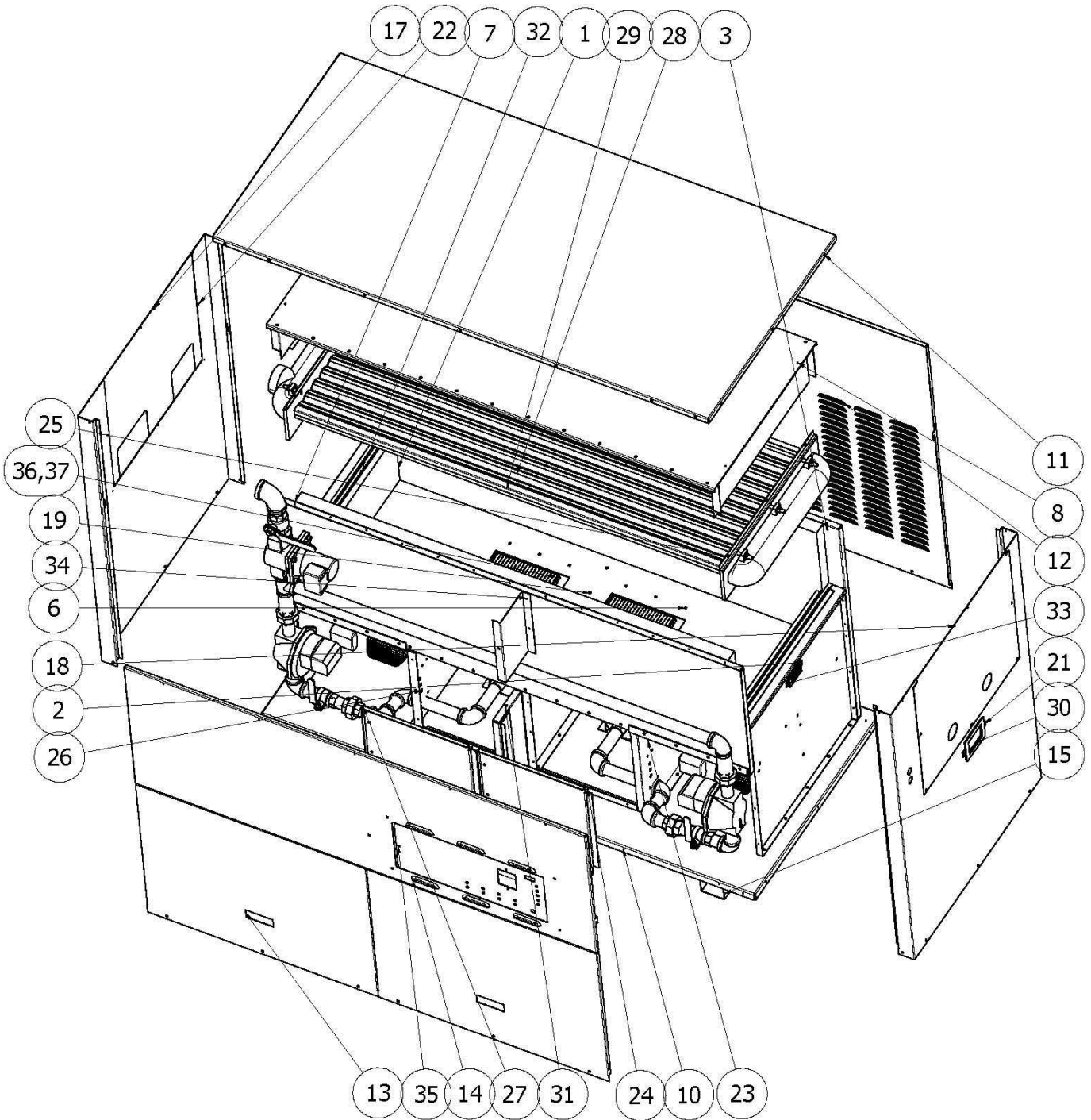

### MICO FLAME REPLACEMENT PARTS LIST

Ref #	Part Name	Model Number						
		800	1000	1200	1400	1600	1800	2000
1	Combustion Chamber End Panel - Left				14-4100			
2	Combustion Chamber End Panel - Right				14-4101			
3	Combustion Chamber Rear Panel				14-4102			
4	Combustion Chamber Support - Left				14-4103			
5	Combustion Chamber Support - Right				14-4104			
6	Combustion Chamber Base				14-4105			
7	Combustion Chamber Upper Support				14-4106			
8	Flue Collector Top				14-4107			
9	Flue Collector End Bracket				14-4108			
10	Base Panel				14-4109			
11	Outer Jacket Top Cover				14-4110			
12	Outer Jacket Back Panel				14-4111			
13	Outer Jacket Front Lower Panel				14-4112			
14	Outer Jacket Front Upper Panel				14-4113			
15	Leg				14-4114			
16	Stiffener				14-4115			
17	Inlet Outlet Side Access Panel				14-4116			
18	Return Side Access Panel				14-4117			

Ref #	Part Name	Model Number						
		800	1000	1200	1400	1600	1800	2000
20	Flue Collector Outlet	14-4119						
21	Outer Jacket Side Panel - Right	14-4131						
22	Outer Jacket Side Panel - Left	14-4132						
23	Fan Mounting Support - Right	14-4133						
24	Burner Door Stop	14-4134						
25	Heat Exchanger Header Stop Bar	14-4138						
26	Fan Mounting Support - Left	14-4139						
27	Burner Door	14-4140						
28	V Baffles	14-4141						
29	HX Front and Back Baffles	14-4142						
30	Outer Jacket Sight Glass Frame	14-4151						
31	Outer Jacket Door Jam	14-4152						
32	Heat Exchanger Support Weldment	14-4153						
33	Inner Jacket Sight Glass Frame	14-4154						
34	Outer Jacket Top Panel Support	14-4155						
35	Control Panel Assembly	14-4160						
36	Two Tiles Burner Box Assembly	N/A		14-4162			N/A	
37	Three Tiles Burner Box Assembly	14-4163		N/A	14-4163			
38	Economizer Cover	14-4146						

Ref #	Part Name	Model Number						
		800	1000	1200	1400	1600	1800	2000
39	Economizer Assembly	14-4148						
40	Fan Mounting Support Left	09-14-4149						
41	Fan Mounting Support Right	09-14-4150						
42	Gas Valve Body	N/A		VGG10.504U				
43	Modulating Fan	G1G170						
44	Gas Valve Actuator	V8730C1023		SKP75.013U1				
45	Gas Valve Body	N/A		VGG10.404U				
45	MicoFlame Modulating harness-1 burner	77-0022		N/A				
	MicoFlame Modulating harness-2 burner main	N/A		77-0024				
46	Mico Modulating harness-Water end harness, right	N/A		77-0027				
	Mico Modulating harness-Water end harness, 2-burner left	N/A		77-0028	N/A			
47	Mico Modulating harness-Panel main (110V)	77-0021		N/A				
	Mico Modulating harness-Panel main (110V)	N/A		77-0030				
	Mico Modulating harness-Panel main (220V)	N/A		77-0031				

\* Condensing Models Only

 Not Shown in Exploded View

## WARRANTY

### GENERAL

Camus Hydronics Limited ("Camus"), extends the following LIMITED WARRANTY to the owner of this appliance, provided that the product has been installed and operated in accordance with the Installation Manual provided with the equipment. Camus will furnish a replacement for, or at Camus option repair, any part that within the period specified below, shall fail in normal use and service at its original installation location due to any defect in workmanship, material or design. The repaired or replacement part will be warranted for only the unexpired portion of the original warranty. This warranty does not cover failures or malfunctions resulting from: (1) Failure to properly install, operate or maintain the equipment in accordance with Camus' manual; (2) Abuse, alteration, accident, fire, flood, foundation problems and the like; (3) Sediment or lime buildup, freezing, or other conditions causing inadequate water circulation; (4) Pitting and erosion caused by high water velocity; (5) Failure of connected systems devices, such as pump or controller; (6) Use of non-factory authorized accessories or other components in conjunction with the system; (7) failing to eliminate air from, or replenish water in, the connected water system; (8) Chemical contamination of combustion air or use of chemical additives to water.

### HEAT EXCHANGER

If within TEN years after initial installation of the appliance, a heat exchanger, shall prove upon examination by Camus to be defective in material or workmanship, Camus will exchange or repair such part or portion on the following pro rated limited warranty. (1) Years one through five - standard warranty (2) Years six through ten - replacement purchase price pro rated at the following schedule: Year six - 60%, Year seven - 65%, Year eight -70%, Year nine -75% Year ten -80% of the current list price of the current list price This term is reduced to FIVE years if the appliance is used for other than hydronic space heating.

Heat Exchanger shall be warranted for (20) years from date of installation against "Thermal Shock" (excluded, however, if caused by appliance operation at large changes exceeding 150 °F between the water temperature at intake and appliance temperature, or operating at appliance temperatures exceeding 230 °F).

### BURNER

If within FIVE years after initial installation of the appliance a burner shall prove upon examination by Camus to be defective in material or workmanship, Camus will exchange or repair such part or portion.

### ANY OTHER PART

If any other part fails within one (1) year after installation, or eighteen (18) months from date of factory shipment based on Camus' records, whichever comes first. Camus will furnish a replacement or repair that part. Replacement parts will be shipped f.o.b. our factory.

### HOW TO MAKE A CLAIM

Any claim under this warranty shall be made directly to Camus Hydronics Limited Canadian Head Office

### SERVICE LABOR RESPONSIBILITY

Camus shall not be responsible for any labour expenses to service, repair or replace the components supplied. Such costs are the responsibility of the owner.

### DISCLAIMERS

Camus shall not be responsible for any water damage. Provisions should be made that in the event of a water/appliance or fitting leak, the resulting flow of water will not cause damage to its surroundings.

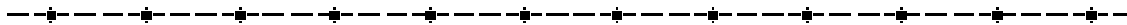

Name of Owner \_\_\_\_\_ Name of Dealer \_\_\_\_\_

Address \_\_\_\_\_ Address \_\_\_\_\_

\_\_\_\_\_

Model No. \_\_\_\_\_ Serial No. \_\_\_\_\_

Date of Installation: \_\_\_\_\_ Date of Initial Operation: \_\_\_\_\_

[6226 Netherhart Road, Mississauga, Ontario, L5T 1B7, CANADA](#)



**CAMUS Hydronics is a manufacturer of replacement parts for most copper finned water heaters and heating boilers as well as a**



**supplier of specialty HVAC products. Our service line is open 24 hours, 7 days a week!**

**The CAMUS CERTIFIED! Seal assures you that Reliability, Efficiency & serviceability are built into every single unit! For more information**

**on our innovative products from CAMUS Hydronics Limited, call 905-696-7800 today.**



***CAMUS HYDRONICS LTD.***

***6226 Netherhart Road Drive, Mississauga, Ontario L5T 1B7***

***TEL: 905-696 7800 FAX: 905-696 8801***